

*Musician's Manual*

---

---

---

MUSIC PRODUCTION SYNTHESIZER

VFX<sup>SD</sup>

**ensoniq**<sup>®</sup>

## READ THIS FIRST!

### WARNING!!

#### Grounding Instructions

This product must be grounded. If it should malfunction or break down, grounding provides a path of least resistance for electric current to reduce the risk of electric shock. This product is equipped with a cord having an equipment-grounding conductor and a grounding plug. The plug must be plugged into an appropriate outlet that is properly installed and grounded in accordance with all local codes and ordinances.

**DANGER:** Improper connection of the equipment-grounding conductor can result in the risk of electric shock. Check with a qualified electrician or service personnel if you are in doubt as to whether the product is properly grounded. Do not modify the plug provided with this product — if it will not fit the outlet, have a proper outlet installed by a qualified electrician.

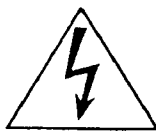
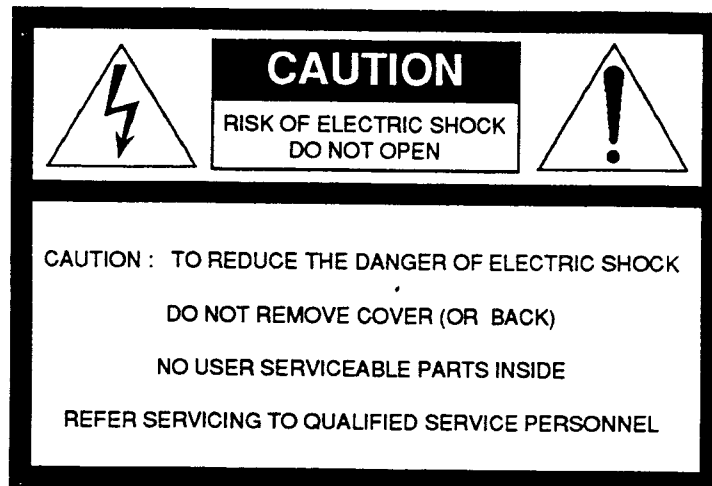

This symbol is intended to alert the user to the presence of uninsulated "dangerous voltage" within the product's enclosure that may be of sufficient magnitude to constitute a risk of electric shock to persons.



This symbol is intended to alert the user to the presence of important operating and maintenance (servicing) instructions in the literature accompanying the appliance.

**SEE IMPORTANT SAFETY INSTRUCTIONS ON BACK COVER!**

**ensoniq®**

**FX<sup>SD</sup>**

**Music Production Synthesizer**

---

**Musician's Manual  
Version 1.4**

## **VFX<sup>SD</sup> Musician's Manual:**

Written, Designed,  
and Illustrated by:

John O. Senior, Bill McCutcheon and Charles Alexander

Cover Design by:

Green Tree Graphics

Copyright © 1989  
ENSONIQ® Corp  
155 Great Valley Parkway  
Malvern, PA 19355

All Rights Reserved

If you have any questions concerning the use of this unit, please contact your authorized ENSONIQ dealer. For additional technical support, or to find the name of the nearest authorized ENSONIQ Repair Station, call ENSONIQ Customer Service at (215) 647-3930 Monday through Friday 9:30 a.m. to 12:00 noon and 1:15 to 6:30 p.m. Eastern Standard Time.

This Manual is copyrighted and all rights are reserved by ENSONIQ Corp. This document may not, in whole or in part, be copied, photocopied, reproduced, translated or reduced to any electronic medium or machine readable form without prior written consent from ENSONIQ Corp. The VFX<sup>SD</sup> software/firmware is copyrighted and all rights are reserved by ENSONIQ Corp.

Although every effort has been made to ensure the accuracy of the text and illustrations in this Manual, no guarantee is made or implied in this regard.

### **IMPORTANT:**

"This equipment generates and uses radio frequency energy and if not installed and used properly, that is, in strict accordance with the manufacturer's instructions, may cause interference to radio and television reception. It has been designed to comply with the limits for a Class B computing device in accordance with the specifications in Subpart J of Part 15 of FCC rules, which are designed to provide reasonable protection against such interference in a residential installation. However, there is no guarantee that interference will not occur in a particular installation. If this equipment does cause interference to radio or television reception, which can be determined by turning the equipment off and on, the user is encouraged to try to correct the interference by one or more of the following measures."

- \* reorient the receiving antenna
- \* relocate the instrument with respect to the receiver
- \* move the instrument away from the receiver
- \* plug the instrument into a different outlet so that the instrument and receiver are on different branch circuits

"If necessary, the user should consult the dealer or an experienced radio/television technician for additional suggestions. The user may find the following booklet prepared by the Federal Communications Commission helpful: 'How to Identify and Resolve Radio-TV Interference Problems.' This booklet is available from the U.S. Government printing Office, Washington, D.C. 20402 Stock No. 004-000-00345-4."

In order to fulfill warranty requirements the VFX<sup>SD</sup> should be serviced only by an authorized ENSONIQ Repair Station.

The ENSONIQ serial number label must appear on the outside of the Unit or the ENSONIQ warranty is void.

\*ENSONIQ, VFX, VFX<sup>SD</sup>, Dynamic Component Synthesis, TransWave, ESQ-1, EPS, and Poly-Key are trademarks of ENSONIQ Corp.



**Section 1 — Getting Started**

Power	1-1
AC Line Conditioning	1-1
Amplification	1-1
Running Your VFX <sup>SD</sup> Through a Home Stereo System	1-2
Rear Panel Connections	1-3
Data Entry — Communicating with the VFX <sup>SD</sup>	1-5
Soft Buttons	1-5
Parametric programming	1-6
Pages	1-6
Sub-pages	1-6
Changing a Parameter	1-7
Performance Controllers	1-8
Pressure	1-8
Cartridge Insertion and Removal	1-9
Re-initializing the VFX <sup>SD</sup>	1-10
Low Battery Voltage — When to replace the Battery	1-11
Available Options	1-11
Need More Help?	1-11

**Section 2 — Playing Sounds and Presets**

Program Memory	2-1
Bank Buttons	2-2
Selecting a Sound	2-2
Choosing Internal, ROM and Cartridge Sounds	2-2
Layering (stacking) a Sound with the Selected Sound	2-3
Primary Sound vs. Layered Sounds	2-3
About Tracks	2-4
Preset Mode vs. Sequencer Mode	2-4
About Presets	2-5
Preset Memory	2-6
Selecting Presets	2-6
Editing a Preset	2-6
Saving a Preset	2-8
Avoiding confusion when using Presets	2-8
Replace Program	2-9
Replacing a program in a Preset	2-9
Replacing a Program and the Effect in a Preset	2-10
Performance Tip — Creating Keyboard splits	2-10

**Section 3 — Performance Parameters**

About Performance Parameters	3-1
Volume Page	3-2
Pan and Timbre Pages	3-3
Key Zone Page	3-4
Transpose Page	3-5
Release Page and Track Control	3-6
Patch Select Page	3-7
Pressure Page	3-8
Sustain Page	3-9
MIDI Status Page	3-10
MIDI Channel Page	3-11
MIDI Program Page	3-12

**Section 4 — Effects**

Understanding VFX <sup>SD</sup> Effects . . . . .	4 - 1
Program, Preset and Sequencer Effects . . . . .	4 - 2
Programming Effects . . . . .	4 - 3
The Effect Busses . . . . .	4 - 3
Effect Mixing . . . . .	4 - 4
Selecting Effects . . . . .	4 - 5
Modulators which can be applied to the effects . . . . .	4 - 5
When are new effects loaded into the ESP chip? . . . . .	4 - 6
Performance control . . . . .	4 - 7
Controllers Routed to Effects . . . . .	4 - 7
Effects Parameters . . . . .	4 - 8

**Section 5 — Sequencer Basics**

Introduction . . . . .	5 - 2
The MIDI Connection . . . . .	5 - 2
Digital Sequencing . . . . .	5 - 2
Loading the Sequencer Operating System from Disk . . . . .	5 - 3
What is a Sequence? . . . . .	5 - 4
What is a Song? . . . . .	5 - 4
Sequencer "Transport Controls" . . . . .	5 - 4
Sequencer Status . . . . .	5 - 5
Sequencer Banks . . . . .	5 - 6
Selecting a Sequence or Song . . . . .	5 - 6
Playing Sequences and Songs . . . . .	5 - 6
Sequencer Tracks . . . . .	5 - 7
Replacing the Program on a Track . . . . .	5 - 8
Layering Programs on The Tracks Pages . . . . .	5 - 8
Sequencer Tracks and the Performance Parameters . . . . .	5 - 8
Copying a Preset into 3 Sequencer Tracks . . . . .	5 - 10
Creating a New Sequence or Song . . . . .	5 - 11
Erasing All Sequencer Memory . . . . .	5 - 12
Sequencer Pages:	
Click Page . . . . .	5 - 13
Seq Control Page . . . . .	5 - 14
Locate Page . . . . .	5 - 18
Edit Times — Using the Autopunch Feature . . . . .	5 - 21
Edit Times in Song Mode . . . . .	5 - 22
Setting the Edit Times in Real Time . . . . .	5 - 22
Recording a Sequence . . . . .	5 - 23
"Punching In" on a Track . . . . .	5 - 25
Playing along with a Sequence/Auditioning New Sounds . . . . .	5 - 25
MIDI Sequencing:	
MIDI Sequencing on the VFX — MIDI Connections . . . . .	5 - 26
MIDI Mode and Channel — Destination Instruments . . . . .	5 - 27
MIDI Track Configuration . . . . .	5 - 27
Recording MIDI Tracks . . . . .	5 - 28
Additional Sequencer Functions:	
Recording Controllers into Sequencer Tracks . . . . .	5 - 29
Recording Program Changes . . . . .	5 - 29
Assigning a Track to the Aux Outputs . . . . .	5 - 30
Using the Aux Outputs as Separate Mono Outs . . . . .	5 - 31
Track Volume Functions — Mixing, Muting, Soloing Tracks . . . . .	5 - 31
Song Mode:	
Switching Effects in Song Mode . . . . .	5 - 32
Song Tracks . . . . .	5 - 33
Viewing Sequence Tracks in Song Mode . . . . .	5 - 34
Mixing Down Sequence and Song Tracks in Song Mode . . . . .	5 - 35
Notes about Mixdown Mode . . . . .	5 - 36

**Section 6 — System Control**

Master Page . . . . .	6 - 1
MIDI Control Page . . . . .	6 - 5

**Section 7 — Programming the VFX<sup>SD</sup>**

What is a Program? . . . . .	7 - 1
Voices and Polyphony . . . . .	7 - 2
Patch Select Buttons . . . . .	7 - 2
Compare — Using the Compare Button/LED . . . . .	7 - 3
Edit Buffer . . . . .	7 - 3
Abandoning Your Edits . . . . .	7 - 3
Select Voice Page . . . . .	7 - 4
Group Edit Mode . . . . .	7 - 5
Programming the Patch Selects . . . . .	7 - 6
Program Control Page . . . . .	7 - 7
Write Page — Saving a New Program into Memory . . . . .	7 - 9

**Section 8 — Voice Programming**

VFX <sup>SD</sup> Voice configuration . . . . .	8 - 1
Modulators . . . . .	8 - 3
About Modulation . . . . .	8 - 3
Selecting a Modulator . . . . .	8 - 3
Modulation Amount . . . . .	8 - 3
Modulation Sources . . . . .	8 - 4
Wave Page . . . . .	8 - 8
Wave Class . . . . .	8 - 8
Wave List . . . . .	8 - 9
General Wave Parameters (All Wave Classes) . . . . .	8 - 10
Type-Specific Wave Parameters . . . . .	8 - 11
VFX <sup>SD</sup> Drum Sounds . . . . .	8 - 14
Pitch Page . . . . .	8 - 16
Pitch Mod Page . . . . .	8 - 17
Filters Page . . . . .	8 - 19
Filter Configurations . . . . .	8 - 21
Output Page . . . . .	8 - 23
LFO Page . . . . .	8 - 27
ENV 1, ENV 2, ENV 3 — VFX <sup>SD</sup> Envelopes . . . . .	8 - 30
Mod Mixer Page . . . . .	8 - 36

**Section 9 — Using Pitch-Tables**

About Pitch-tables . . . . .	9 - 1
How to Create a Custom Pitch-table . . . . .	9 - 2
Editing a Custom Pitch-table . . . . .	9 - 3
Removing a Custom Pitch-table . . . . .	9 - 4
Creating and Extrapolating a Custom Pitch-table . . . . .	9 - 4
Creating and Interpolating a Custom Pitch-table . . . . .	9 - 6
Alternate tunings for the System Pitch-table . . . . .	9 - 6

**Section 10 — Using the Copy Functions**

About the Copy Functions . . . . .	10 - 1
Copy contexts and MAKE COPY . . . . .	10 - 2
RECALL . . . . .	10 - 3
Special Recall Functions . . . . .	10 - 3
Special Copy Operations . . . . .	

DEFAULT . . . . .	10 - 4
SYSTEM . . . . .	10 - 5
Useful Applications of the Copy Functions	
Copying an effect from one program to another . . . . .	10 - 5
Copying all parameters from one voice to another . . . . .	10 - 5
Copying a complete program to a new location . . . . .	10 - 6
Making a copy of the compare buffer . . . . .	10 - 6
Collecting parts from several sources into the copy buffer . . . . .	10 - 6
<b>Section 11 — Storage Functions</b>	
Disk Storage	
VFX <sup>SD</sup> Disk File Types . . . . .	11 - 2
Disk Capacity — Bytes, Blocks and Files . . . . .	11 - 3
File Banks . . . . .	11 - 4
VFX <sup>SD</sup> Disk Functions . . . . .	11 - 4
Format . . . . .	11 - 5
Copy . . . . .	11 - 6
Save . . . . .	11 - 7
Load . . . . .	11 - 10
Delete . . . . .	11 - 12
MIDI Sys-Ex	
Sending Programs . . . . .	11 - 13
Sending Presets, Sequencer Data, and All Data . . . . .	11 - 14
Cartridge	
Copying Programs from Internal to Cartridge . . . . .	11 - 15
Copying Programs from Cartridge to Internal . . . . .	11 - 16
Copying Presets from Cartridge to Internal . . . . .	11 - 16
Copying Presets from Internal to Cartridge . . . . .	11 - 17
Copying Both from Internal to Cartridge . . . . .	11 - 18
Copying Both from Cartridge to Internal . . . . .	11 - 19
MIDI System Exclusive Recorder . . . . .	11 - 20
Saving Sys-Ex Data from an External Device . . . . .	11 - 21
Loading Sys-Ex Data from Disk to an External Device . . . . .	11 - 23
Additional Sys-Ex Recorder Notes . . . . .	11 - 24
VFX <sup>SD</sup> Disk Error Messages . . . . .	11 - 25
<b>Section 12 — Sequencer Edit Functions</b>	
Edit Song Page — Song Edit Functions . . . . .	12 - 1
Editing Song Steps — Using the Song Step Editor . . . . .	12 - 4
Edit Seq Page — Sequence Edit Functions . . . . .	12 - 6
Edit Track Page — Track Edit Functions . . . . .	12 - 10
Edit Track Range Page — Setting the Time and Key range . . . . .	12 - 10
Track Edit Functions . . . . .	12 - 11
<b>Section 13 — Sequencer Applications</b>	
Using the VFX <sup>SD</sup> with a Drum Machine . . . . .	13 - 1
Song Position Pointers . . . . .	13 - 2
MIDI Song Selects . . . . .	13 - 2
MIDI Controller Tricks — Creating Template Sequences . . . . .	13 - 2
MULTI Mode — Receiving on up to 12 MIDI channels . . . . .	13 - 4
A Few Important Points About Multi Mode . . . . .	13 - 4
Using the VFX <sup>SD</sup> with an External MIDI Sequencer . . . . .	13 - 5
Using The VFX <sup>SD</sup> with a MIDI Guitar Controller . . . . .	13 - 6
<b>Appendix A — VFX<sup>SD</sup> MIDI Specification</b>	
<b>Appendix B — MIDI Implementation Chart</b>	
<b>Index</b>	

## Section 1 — Getting Started

Power . . . . .	1 - 1
AC Line Conditioning . . . . .	1 - 1
Amplification . . . . .	1 - 1
Running Your VFX <sup>SD</sup> Through a Home Stereo System . . . . .	1 - 2
Rear Panel Connections . . . . .	1 - 3
Data Entry — Communicating with the VFX <sup>SD</sup> . . . . .	1 - 5
Soft Buttons . . . . .	1 - 5
Parametric programming . . . . .	1 - 6
Pages . . . . .	1 - 6
Sub-pages . . . . .	1 - 6
Changing a Parameter . . . . .	1 - 7
Performance Controllers . . . . .	1 - 8
Pressure . . . . .	1 - 8
Cartridge Insertion and Removal . . . . .	1 - 9
Re-initializing the VFX <sup>SD</sup> . . . . .	1 - 10
Low Battery Voltage — When to replace the Battery . . . . .	1 - 11
Available Options . . . . .	1 - 11
Need More Help? . . . . .	1 - 11

### Power

Insert the line cord into the line receptacle on the back of the VFX<sup>SD</sup>, next to the Power switch. Plug the other end of the cable into a grounded AC outlet. (The proper voltage for your VFX<sup>SD</sup> is listed on the Serial Number label on the rear panel.) Turn the VFX<sup>SD</sup> power on and make sure the display lights up. If not, check your connections and power source.

The first thing the VFX<sup>SD</sup> does when it starts up is calibrate the keyboard. Be sure not to touch the keyboard while the display reads CALIBRATING KEYBOARD - DO NOT TOUCH.

### AC Line Conditioning

As is the case with any computer device, the VFX<sup>SD</sup> is sensitive to sharp peaks and drops in the AC line voltage. Lightning strikes, power drops or sudden and erratic surges in the AC line voltage can scramble the internal memory and, in some cases, damage the unit's hardware. Here are a few suggestions to help guard against such occurrences:

- A Surge/Spike Suppressor. The cheaper of the options, a surge/spike suppressor absorbs surges and protects your gear from all but the most severe over-voltage conditions. You can get multi-outlet power strips with built-in surge/spike suppressors for little more than the cost of unprotected power strips, so using one is a good investment for all your electronic equipment.
- A Line Conditioner. This is the best, but by far the more expensive, way to protect your gear. In addition to protecting against surges and spikes, a line conditioner guards the equipment against excessively high or low line voltages. If you use the VFX<sup>SD</sup> in lots of different locations with varying or unknown AC line conditions, you might consider investing in a line conditioner.

### Amplification

Connect the Main Audio Outputs of the VFX<sup>SD</sup> to the line level inputs of a mixer, instrument amplifier, stereo, or any other sound system, using 1/4 inch audio

cables. For an additional set of dry outputs, connect the Aux Outputs to two more mixer channels. If your system is stereo, connect the Left and Right Outputs to two channels of your mixer, stereo, etc. If it's mono, use either of the Audio Outputs, but make sure nothing is plugged into the other output. For listening through headphones, plug the phones into the rear-panel jack marked *Phones*. If you're running the VFX<sup>SD</sup> through a mixer, in stereo, be sure to pan the Left input fully left, and the Right input fully right.

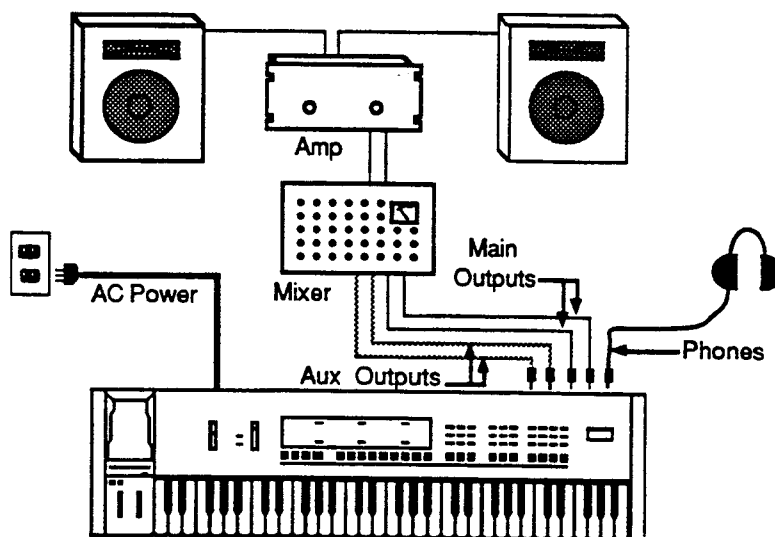

It is a good idea to make sure your audio system is turned off (or down) when making connections, to avoid damaging speakers or other components.

**Note:**

The VFX<sup>SD</sup> outputs are line-level, and are intended to be connected only to line-level inputs, such as those on a mixer, stereo pre-amp, keyboard amp, etc. Connecting the VFX<sup>SD</sup> audio outputs to a mic-level input, such as a guitar amp or the microphone jacks on a tape deck, is not recommended, and might result in damage to the device input.

Move the volume fader *all the way up*. As with any digital musical instrument, the VFX<sup>SD</sup> will give the best results if you keep the volume slider full on, and use the volume control on your mixer or amp to adjust its level.

Switch the audio system on, and adjust the amplifier volume for normal listening levels. If you hear no sound while playing the keyboard, switch the audio system off and check your connections.

### Running Your VFX<sup>SD</sup> Through a Home Stereo System

If you are thinking about amplifying your VFX<sup>SD</sup> through your home stereo, a word of caution. A home stereo is great for playing CD's, albums, tapes — the dynamic range of these media is limited, and your speakers aren't usually subjected to extreme volume changes and frequency transients. While the dynamic range of CD's is significantly greater than LP's or tapes, the output of a CD player is still conservative compared to the uncompressed, unlimited line-level output of a pro-level keyboard. Running your VFX<sup>SD</sup> — or any pro-level keyboard — through a home stereo at high volume levels can damage your speakers, not to mention the impedance mis-match this can create. If your only means of amplification is your home stereo, then try to keep your levels on the conservative side.

## Rear Panel Connections

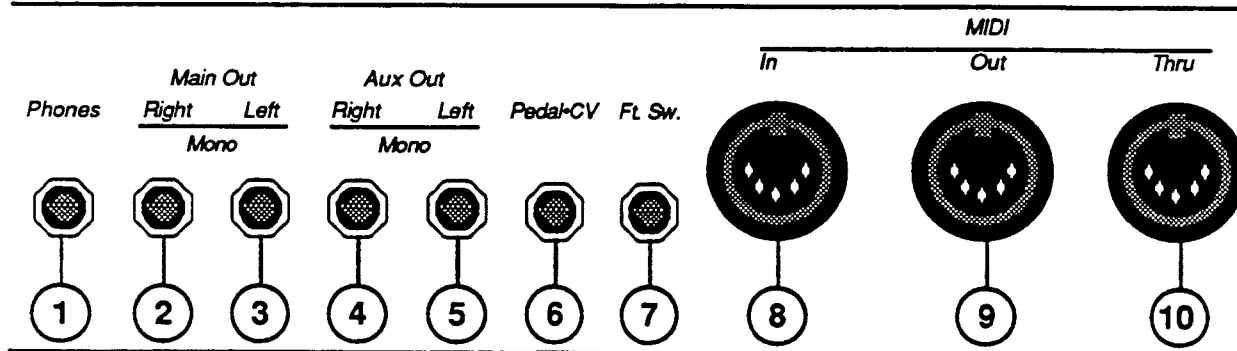

### 1) Phones

To listen to the VFX<sup>SD</sup> in stereo through headphones, plug the phones into this jack. The Phones output contains a mix of the signal from the main outputs and the aux. outputs. Headphone volume is controlled by the volume slider on the front panel. (Note that plugging headphones into this jack *does not* automatically turn off the audio in the regular left and right outputs.)

### 2) Main Out Right/Mono

To operate the VFX<sup>SD</sup> in stereo, connect this output to a channel of your mixer and pan that channel right. Note that *either* of the audio outputs can be used as a mono output. If you want to use this jack to listen to the main outputs in mono, make sure that nothing is connected to the Main Out Left/Mono jack.

### 3) Main Out Left/Mono

When operating the VFX<sup>SD</sup> in stereo, connect this output to a channel of your mixer and pan that channel left. To use this jack to listen to the main outputs in mono, make sure that nothing is connected to the Main Out Right/Mono jack.

### 4) Aux. Out Right/Mono

The Aux. Outputs provide an additional stereo output for use in mixing down sequences, etc. The Aux. Output contains the dry (no effects) signal only, allowing you to process and mix certain sounds separately. VFX<sup>SD</sup> sounds can be routed to the Aux. Outputs from the Performance Effects page, or individual voices can be set to the Aux. Output from the Output page. When using the Aux. Outputs in stereo, connect this output to a channel of your mixer and pan that channel right. To use this jack as a mono output, make sure that nothing is connected to the Aux. Out Left/Mono jack.

### 5) Aux. Out Left/Mono

Contains the left channel of the Aux. Outputs. When using the Aux. Outputs in stereo, connect this output to a channel of your mixer and pan that channel left. To use this jack as a mono output, make sure that nothing is connected to the Aux. Out Right/Mono jack.

### 6) Pedal/CV

This jack is for connecting an optional ENSONIQ Model CVP-1 Control Voltage Foot Pedal, which is assignable as a modulator to various parameters within the VFX<sup>SD</sup>. The pedal gives you a handy alternative modulation source when, for example, you would want to use the mod wheel but both hands are busy.

A CV pedal plugged into this jack can also act a volume pedal, controlling the overall volume level of the VFX<sup>SD</sup>. A parameter on the Master page (press *Master*, then underline PEDAL=MOD/VOL), determines whether the CV pedal will act as a modulator or as a volume pedal. Set to PEDAL=VOL to use the CV pedal to control the volume of the VFX<sup>SD</sup>.

Pedal/CV Specs: 3-conductor (Tip=control voltage input, Ring=2 KOhm resistor to +12 Volts, Sleeve= ground). 68 KOhm input impedance, DC coupled. Input voltage range=0 to 10 volts DC. Scan rate=32mS (maximum recommended modulation input= 15 Hz). For use with an external control voltage, use a 2-conductor cable with the voltage on the tip and the sleeve grounded.

### 7) Foot Switch Input

This jack supports either one or two Footswitches depending on what is plugged into it:

- If you plug the ENSONIQ Model SW-1 Foot Switch (which came with your VFX<sup>SD</sup>) into this jack, it will act as a sustain pedal. Holding it down will cause notes to continue to sustain after the key has been released. It can also be assigned to act as the right Patch Select button.
- Or you can connect the optional ENSONIQ Model SW-5 Dual Foot Switch here. The SW-5 is a dual (piano-type) foot switch with two separate pedals. When the SW-5 is connected, the right-hand pedal will act as a sustain pedal and the left-hand pedal will act as an Auxiliary Foot Switch.

When the SW-1 is connected to the FootSwitch jack:

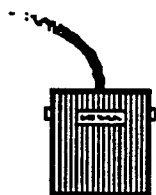

It acts as the Sustain Foot Switch.

When the SW-5 is connected to the FootSwitch jack:

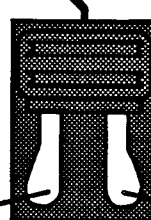

The left pedal acts as the Aux. Foot Switch.

The right pedal acts as the Sustain Foot Switch.

There are two parameters on the Master Page which let you reassign the footswitches to a variety of functions, including reproducing the actions of the Patch Select buttons and starting and stopping the sequencer. See Master page, Section 6 for more.

### 8) MIDI In

This jack receives MIDI (Musical Instrument Digital Interface) information from other MIDI instruments or computers.

### 9) MIDI Out

Sends out MIDI information to other instruments and computers.

### 10) MIDI Thru

"Passes on" all MIDI information received by VFX<sup>SD</sup> to other devices. Information generated by the VFX<sup>SD</sup> itself does not go to this jack — the Thru jack merely echoes what comes in at the MIDI In jack.



### Data Entry — Communicating with the VFX<sup>SD</sup>

Almost everything you do on the VFX<sup>SD</sup> — whether it's selecting a sound, editing that sound, adjusting the tuning, etc. — is controlled from the front panel using the following controls:

- The 80 character fluorescent display,
- The six "soft" buttons directly above and below the display,
- The data entry slider to the left of the display, and
- The up and down arrow buttons to the left of the data entry slider.

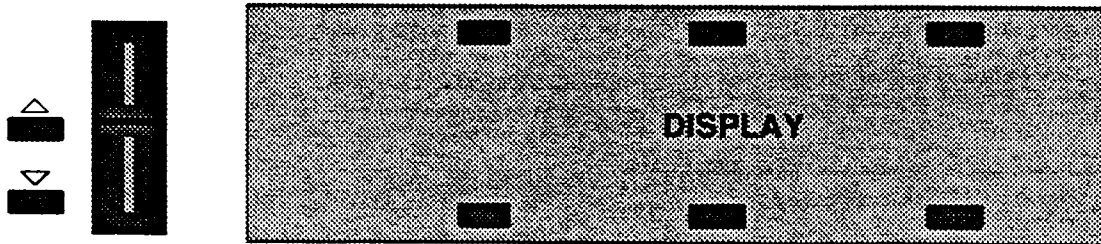

The display and the data entry controls are primarily used to *select* and *modify* things — programs, parameters, keyboard touch, MIDI Control functions, etc. — all depending on which front panel button you press. Try pressing a few of the other buttons — *Master*, *MIDI*, *LFO*, or *Filters*, for example — and watch the display. Notice that for each button you press, the display changes to show you information related to that function. Each of these different display configurations is called a *Page*.

### Soft Buttons

The six buttons above and below the display have a new function each time you select a new page — that is, each time you press one of the buttons outside the data entry section. Each of these six buttons is used to select whatever is directly above or below it on the display.

Because their function varies depending on what is displayed, we refer to these buttons as *Soft Buttons*, to distinguish them from buttons which have fixed, "hard," functions, such as the Page buttons.

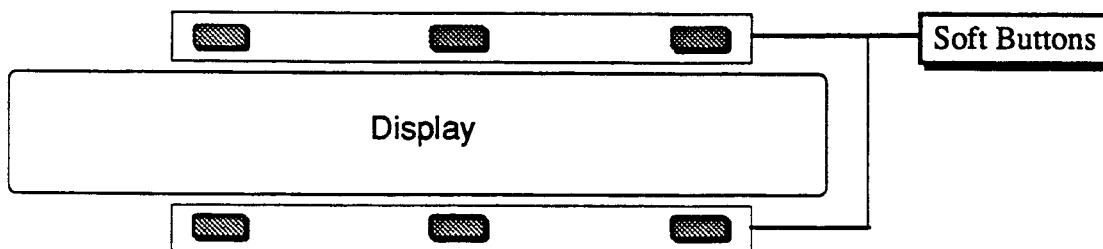

**Parametric programming**

The method used to modify or edit programs, presets and system parameters is called *Page-driven Parametric Programming*, which sounds like a mouthful, but don't worry. Once you've grasped a few basic concepts you'll find that operating the VFX<sup>SD</sup> is quite simple, given its many capabilities.

It is likely that you have already encountered some form of parametric programming on other synthesizers. What this means is that instead of having a separate knob or slider for each function, you have one master *Data Entry Slider*, and two arrow buttons, which adjust the value of whichever parameter you select.

This approach has many advantages, the most obvious of which is that it greatly reduces the amount of hardware — knobs, switches, faders, etc. — needed to control a wide variety of functions. (If the VFX<sup>SD</sup> had a separate control for each function, it would literally have hundreds of knobs.)

**Pages**

The VFX<sup>SD</sup> 80-character fluorescent display makes it possible to display information in *Pages*. Each time you press one of the front panel buttons, you are in effect "turning to" that function's page. Once you have turned to the page you want, the display shows you which parameters are controlled from that page.

**Sub-pages**

Some of the VFX<sup>SD</sup> pages contain more than one screen full of information. Where a page consists of multiple sub-pages, this is indicated on the front panel by a "multi-page" symbol above the name:

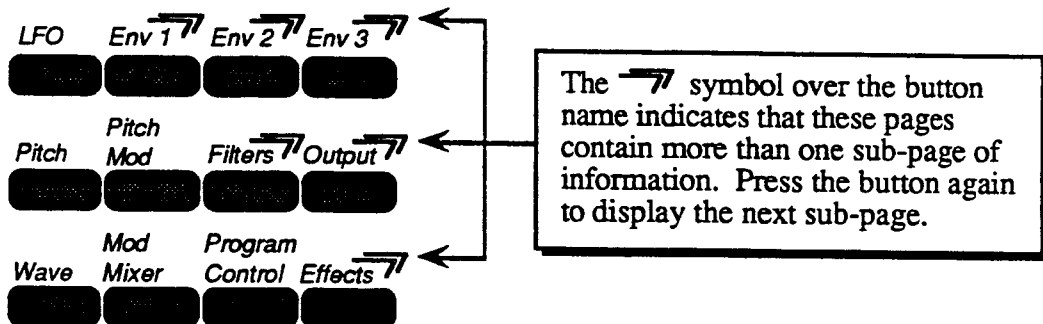

Continuing to press the page button will cycle through the sub-pages.

## Changing a Parameter

Suppose you want to adjust the master tuning of the VFX<sup>SD</sup>. Press the front panel button labeled *Master*. The display now shows the Master page. It should look like this:

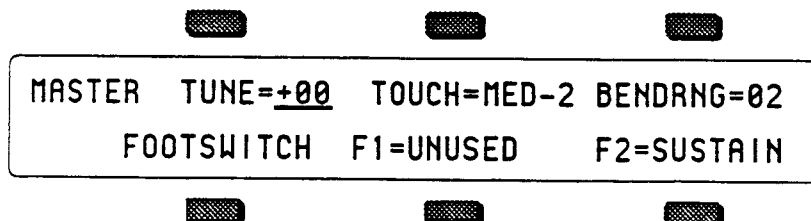

In the top left-hand corner of the display you will always find the *name* of the page, which corresponds to that of the button you pressed. To the right of that are the various parameters which can be selected and modified from this page.

To raise or lower the tuning of the VFX<sup>SD</sup>, press the button directly above where it says TUNE=+00. This segment of the display will now be underlined, telling you that it has been *selected*, and can be modified.

*The currently selected parameter on a page is always underlined.*

Once you have selected a parameter to be modified, use the data entry slider and the up and down arrow buttons to the left of the display to adjust its value:

- Moving the slider will scroll the entire range of available values. If you move the slider slowly it will change the parameter relative to the current value. Moving it quickly will cause the parameter to jump to the absolute value which corresponds to the position of the slider.
- Pressing the up and down arrow buttons will increase or decrease the value one step at a time. Continuing to hold down either button will cause it to accelerate and run quickly through the values.

### Hint:

There is a quick way to center or "zero out" the value of any parameter which has a center value, as the TUNE parameter does. Press the down arrow button, and *while holding it down*, press the up arrow button, then quickly release both buttons. This automatically sets the parameter value to +00.

To select and modify another parameter on the same page, press the soft button above or below its name. That parameter will now be underlined, and its value can be adjusted as before, with the data entry slider and the up and down arrow buttons.

If you select another page, change some parameter on that page, and then return to the Master page, the parameter you had last selected will still be underlined. The VFX<sup>SD</sup> always "remembers" which parameter was last selected on a given page (including each sub-page where there are more than one).

Be sure that the parameter you want to edit is selected before moving the data entry slider and/or the up and down arrow buttons. There is *always* a parameter selected on any given programming page.

## Performance Controllers

The VFX<sup>SD</sup> features a number of real-time performance *controllers* which are used to modify sounds as you play for maximum expressiveness. Three of the most important controllers are located to the left of the keyboard:

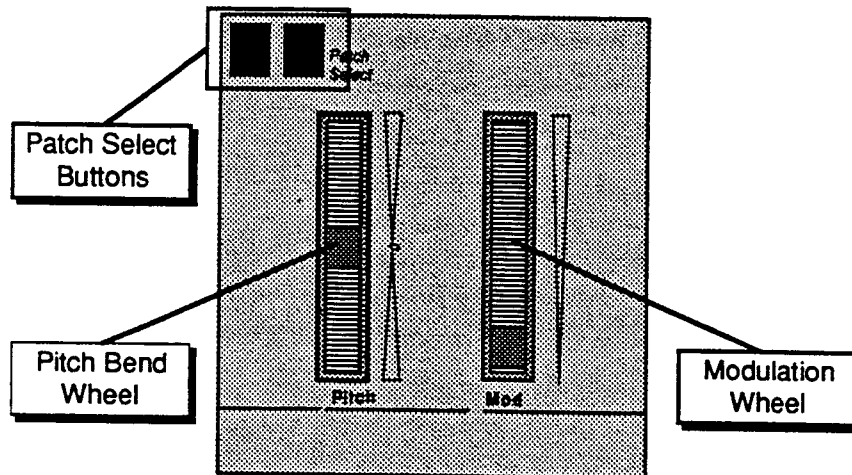

- **PATCH SELECT BUTTONS** — These two buttons are used to select alternate groups of voices within a sound. The VFX<sup>SD</sup> can be programmed so that the sound changes (sometimes in subtle ways, sometimes radically) when you play notes with one or both Patch Select buttons held down. As you try the programs in the VFX<sup>SD</sup>, make sure you explore what these buttons do to each sound.
- **PITCH BEND WHEEL** — This wheel bends the pitch of a note up or down. The wheel is normally centered, where it has no effect on the pitch— moving the wheel up or down will bend the note by the amount specified in the Bend Range parameters contained on the Master page (for global bend range) and on the Program Control page (for setting an individual program's bend range separately).
- **MODULATION WHEEL** — Perhaps the most common use of the Mod Wheel is to add vibrato, but it can also be assigned as a modulator anywhere within the VFX<sup>SD</sup> voice architecture to alter the pitch, brightness, volume and a great many other aspects of the sound.

Among the other controllers which are available to modify a sound are the optional CVP-1 foot pedal and key pressure (see below).

### Pressure (After-touch)

Another important controller is *Pressure*. Pressure (often called after-touch) is a modulator which allows you to change the sound in various ways by pressing down harder on a key or keys after the initial keystroke. The VFX<sup>SD</sup> keyboard is capable of generating two types of pressure — *Poly-Key™ Pressure* and *Channel Pressure*.

Like the mod wheel or foot pedal, pressure is a modulator, and can be chosen wherever a modulator is selected in the Programming section of the VFX<sup>SD</sup>. Pressure can be assigned to alter the pitch or volume of voices, the filter cutoff frequency, LFO depth, pan location, etc.

There are two types of Pressure:

- Channel Pressure, also called Mono pressure, affects all notes that are playing when you exert pressure on any of the keys. If, for example, you play a three-note chord, pressing down harder on any of the three notes of the chord will modulate *all three notes*. This type of pressure is the more common of the two types.

Most MIDI instruments which currently implement pressure send and receive only channel pressure. If you are playing such an instrument from the VFX<sup>SD</sup>, you should set the VFX<sup>SD</sup> to send channel pressure. (Note that some devices, including *all* ENSONIQ products respond to both types of pressure.)

- Poly-Key Pressure, also referred to as Polyphonic pressure, is a more sophisticated and expressive type of pressure. Poly-Key pressure affects each key independently. If, for example, you play a three-note chord, pressing down harder on any of the three notes of the chord will modulate *only that note*. The other two notes will remain unaffected.

Each preset or sequencer track can be programmed to generate Poly-Key pressure, channel pressure or none at all. If you wish to change the pressure type for a given track, you can do so on the second sub-page of the Patch Select page in the Performance section of the VFX<sup>SD</sup>. See Section 3 for more details.

Note that Poly-Key pressure generates a tremendous amount of data, and will consume sequencer memory much faster than other types of events, such as notes and program changes. You should turn pressure off when sequencing instruments which do not respond to pressure, such as piano and drum sounds.

### Cartridge Insertion and Removal

Before you can play sounds and presets from a cartridge, you must first insert into the Cartridge slot an ENSONIQ VPC-100 series ROM cartridge, a Stor-Cart 32 E<sup>2</sup>PROM cartridge, or other VFX-compatible program cartridge, as shown below with the label facing towards you. Take care to insert the cartridge straight into the slot in a continuous fashion.

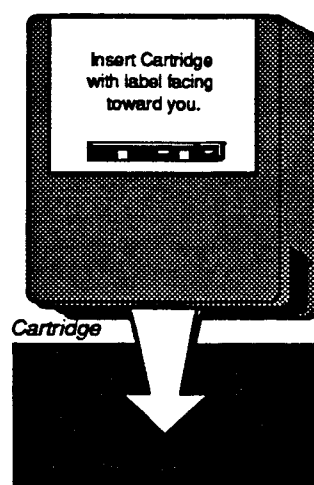

Program cartridges can be inserted or removed at any time (except while you're writing programs to them), even when the power is on, without doing any harm to the VFX<sup>SD</sup> or the cartridge.

## Re-initializing the VFX<sup>SD</sup>

The great power and flexibility of the VFX<sup>SD</sup> lies in the fact that it is really a computer — a computer disguised as a keyboard instrument, but a computer nonetheless. The software that operates the VFX<sup>SD</sup> is very sophisticated. In fact, there is a 128k computer program that runs inside the VFX<sup>SD</sup> (the Operating System code). That's more than many personal computers. If you have ever used a computer, you should be familiar with the need to occasionally re-boot your system when you get an error message, etc. Re-initializing the VFX<sup>SD</sup> is the equivalent of re-booting your computer.

There are a number of things that can happen to the VFX<sup>SD</sup> (or any computer system) which might scramble the system software — voltage surges, power failures, static electricity, etc. And as with any computer, very infrequently some unforeseeable event or combination of events can cause the software to become confused, with strange and unpredictable results. Sometimes, computers which appear to be broken have no hardware problem, just corrupted data in the internal RAM (Random Access Memory). In some cases, simply turning the VFX<sup>SD</sup> power off and then on again will cure the problem. If that doesn't work, perhaps what is needed is to re-initialize the unit.

### When to Re-initialize

If your VFX<sup>SD</sup> begins to behave in peculiar ways; if the display shows words or lines that shouldn't be there; if you start getting unexplained System Error messages; if the sequencer and edit functions start doing unpredictable things; try re-initializing the VFX<sup>SD</sup> before you seek factory service.

### Warning:

When you re-initialize your VFX<sup>SD</sup> all your current internal sounds, presets, and sequences will be lost. (The 60 ROM (Read Only Memory) sounds are automatically loaded back into the internal memory after re-initializing.) Therefore good backup habits should be an important part of your routine. Save any important data to disk or to a cartridge before re-initializing the VFX<sup>SD</sup>.

### To Re-initialize the VFX<sup>SD</sup>:

- While holding down the *Presets* button, press the "soft" button in the top left corner above the fluorescent display.
- The following message appears on the display: "ERASE MEMORY AND REINITIALIZE"
- Select \*YES\*. After selecting \*YES\*, the VFX<sup>SD</sup> erases its internal memory and then starts up just as it does when you turn the power on, and initialization is complete. When you re-initialize the VFX<sup>SD</sup>, the ROM Programs are automatically placed in the Internal Memory.
- After re-initializing, you will need to reload the Sequencer Operating System from your master VFX<sup>SD</sup> disk. (See "Loading Data from Disk", Section 11.)

If re-initializing your VFX<sup>SD</sup> does not correct the problem, then contact an authorized ENSONIQ Repair Station.

**Low Battery Voltage — When to replace the Battery**

The reason that the VFX<sup>SD</sup> "remembers" programs, presets and other parameters, even when the power is off, is that all of its internal RAM is "battery-backed-up." The battery that keeps the VFX<sup>SD</sup> memory intact is located inside the VFX<sup>SD</sup>, and when it becomes discharged, it must be replaced by an authorized ENSONIQ Repair Station.

The battery that came in your VFX<sup>SD</sup> is good for up to five years of life. You will know when it needs replacing, because the VFX<sup>SD</sup> will tell you so. One day you will switch the power on, and instead of its usual wake-up message, the display will read:

WARNING -- LOW BATTERY VOLTAGE  
SAVE DATA - SEE USER MANUAL \*CONTINUE\*

Press \*CONTINUE\* (or any button) to commence normal operation. Then, make sure that all sequences, programs and presets are saved to disk or cartridge, and take the VFX<sup>SD</sup> to an authorized ENSONIQ Repair Station as soon as possible to have the battery replaced.

**Available Options**

These optional accessories are available from your ENSONIQ dealer:

- **ENSONIQ Model SW-5 Foot Switch** — For voice sustain, sostenuto, patch select, preset advance or starting and stopping a remote sequencer.
- **Model CVP-1 CV PEDAL** — A *Control Voltage Foot Pedal* which can be assigned as a modulator within the voice section of the VFX<sup>SD</sup> or used as a volume pedal.
- **Stor-Cart 32 E<sup>2</sup>PROM Storage Cartridge** — For storing the programs and presets you create or edit. Programs and presets can be saved to the Stor-Cart 32 just like the internal memory. The 60 programs and 20 presets in the program cartridge, combined with the internal RAM and ROM, give you 180 programs and 60 presets instantly available for performance.
- **VPC-100 series ROM Cartridges** — Containing 60 factory-programmed sounds and 20 presets. Unlike the Stor-Cart 32, the programs and presets in the VPC cartridges are stored permanently there and cannot be replaced.

**Need More Help?**

Whether you're an aspiring programmer looking for additional information about basic synthesizer and MIDI theory, or a professional sound designer working with advanced applications, you may want more detailed information that is beyond the scope of this manual. The following books can help enhance your understanding of synthesis, MIDI, and related topics. These, in addition to the numerous monthly magazines, provide a wealth of information. While we don't endorse any one of these publications, we offer this partial list as a resource for you to draw on.

**Alexander Publishing**

For prices and additional information call: 1-800-633-1123

**MIDI**

1989—*HOW MIDI WORKS*, Dan Walker

*MURPHY'S LAW MIDI BOOK*, Jeff Burger  
**SAMPLING**  
*SAMPLING BASICS*, Bob Maestas  
**SEQUENCING**  
*SEQUENCING AND ARRANGING Vol's 1-4*, Joesph Wagner  
**SYNTHESIZERS**  
*RECORDING, SYNCING & SYNTHS*, Paul Goldfield  
*TEACH YOURSELF KEYBOARD PLAYING & IMPROVISING*,  
Vol's 1 & 2, Dr. Jack Wheaton

**The Mix Bookshelf**

For prices and more information call: 1-800-233-9604

In California call: 1-800-641-3349

**MIDI**

*MIDI FOR MUSICIANS*, Craig Anderton  
*MUSIC THROUGH MIDI*, Michael Boom  
*THE MIDI HOME STUDIO*, Howard Massey  
*THE MIDI BOOK*, Steve De Furia  
*MIDI RESOURCE*, Steve De Furia  
*MIDI IMPLEMENTATION BOOK*, Steve De Furia  
*THE MIDI SYSTEM EXCLUSIVE BOOK*, Steve De Furia  
*USING MIDI*, Helen Casabona, David Frederick  
*MIDI, THE INS, OUTS AND THRUS*, Jeff Rona

**SAMPLING**

*THE SAMPLING BOOK*, Steve De Furia, Joe Scacciaferro

**SYNTHESIZERS**

*GUITAR SYNTH & MIDI*, Guitar Player Magazine  
*SECRETS OF ANALOG AND DIGITAL SYNTHESIS*, Steve De Furia  
*BEGINNING SYNTHESIZER*, Helen Casabona, David Frederick  
*THE NEW COMPLETE SYNTHESIZER*, David Crombie  
*SYNTHESIZER BASICS*, Dean Friedman  
*THE KEYBOARD SYNTHESIZER LIBRARY*, Keyboard Magazine  
*A SYNTHESIST'S GUIDE TO ACOUSTIC INSTRUMENTS*, Howard Massey

**GPI Books**

For prices and more information call 1-800-999-9018

**MIDI**

*ADVANCED MIDI APPLICATIONS BASIC MIDI APPLICATIONS*  
*MIND OVER MIDI*  
*USING MIDI*  
*WHAT IS MIDI?*

**SYNTHESIZERS**

*ART OF ELECTRONIC MUSIC*  
*BEGINNING SYNTHESIZER*  
*PLAYING SYNTHESIZERS*  
*PROGRAMMING SYNTHESIZERS*  
*SYNTHESIZERS AND COMPUTERS (REVISED)*  
*SYNTHESIZER BASICS (REVISED)*  
*SYNTHESIZER PROGRAMMING*  
*SYNTHESIZER TECHNIQUE (REVISED)*



## Section 2 — Playing Sounds and Presets

Program Memory . . . . .	2 - 1
Bank Buttons . . . . .	2 - 2
Selecting a Sound . . . . .	2 - 2
Choosing Internal, ROM and Cartridge Sounds . . . . .	2 - 2
Layering (stacking) a Sound with the Selected Sound . . . . .	2 - 3
Primary Sound vs. Layered Sounds . . . . .	2 - 3
About Tracks . . . . .	2 - 4
Preset Mode vs. Sequencer Mode . . . . .	2 - 4
About Presets . . . . .	2 - 5
Preset Memory . . . . .	2 - 6
Selecting Presets . . . . .	2 - 6
Editing a Preset . . . . .	2 - 6
Saving a Preset . . . . .	2 - 8
Avoiding confusion when using Presets . . . . .	2 - 8
Replace Program . . . . .	2 - 9
Replacing a program in a Preset . . . . .	2 - 9
Replacing a Program and the Effect in a Preset . . . . .	2 - 10
Performance Tip — Creating Keyboard splits . . . . .	2 - 10

### Program Memory

Each VFX<sup>SD</sup> sound is a complex structure consisting of up to six voices per key and a programmable effects setup. We refer to these sounds as *Programs*. In this manual we will use the words *program* and *sound* interchangeably to describe VFX<sup>SD</sup> programs. The VFX<sup>SD</sup> gives you access to up to 180 different sounds at any time:

- INT — 60 sounds are stored in the VFX<sup>SD</sup> *Internal Memory* (RAM).
- ROM — Another 60 sounds are permanently stored in its *ROM Memory*. Like the INT sounds the ROM (read only memory) sounds are contained within the VFX<sup>SD</sup>; but unlike the INT sounds they cannot be modified or replaced.
- CART — 60 additional sounds can be stored in a cartridge plugged into the cartridge port.

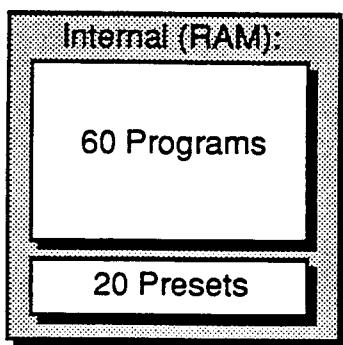

Sounds and Presets stored in Internal RAM Memory can be played, edited and replaced with other sounds or presets.

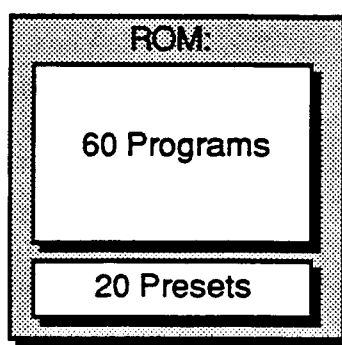

Sounds and Presets stored in the ROM Memory can be played and edited, but cannot be erased. Edited versions can be stored in Internal Memory or E2PROM cartridge.

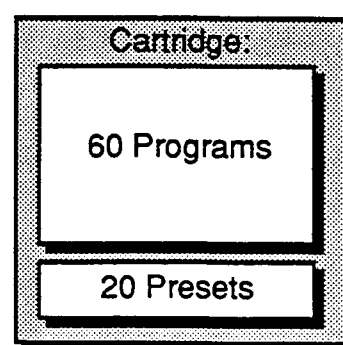

Sounds and Presets stored in the cartridge can be played and edited. You can save edited sounds and presets to Internal RAM memory or E2PROM cartridge.

## Bank Buttons

When the *Sounds* LED is lit, the ten Bank buttons, labeled 0 through 9 and located beneath the display, are used to call up the programs in memory, six at a time, allowing you to then select the one you want to play. We call these groups of six programs *Program Bank pages*.

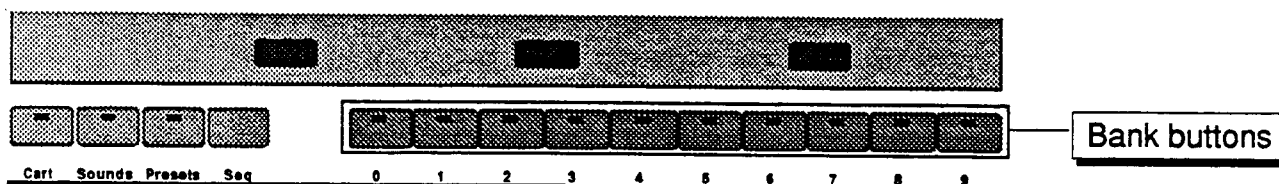

The Bank buttons also select presets when the *Presets* LED is lit (more about presets later). If you press the *Seq* button, none of the LEDs are lit and the ten Bank buttons select sequencer banks.

## Selecting a sound

To select a VFX<sup>SD</sup> program:

- Press *Sounds*.
- Press one of the 10 Bank buttons below the display (numbered 0-9) to select a bank of six programs. The display shows you the names of the six programs in each bank.
- Press the button above or below any of the six program names to select that program as the current sound. Try selecting and playing a few different sounds. Notice that when you select a program, its name is underlined. The currently selected program is always underlined.

## Choosing Internal, ROM and Cartridge Sounds

The *Cart* button is used to choose between internal, ROM and cartridge sounds. The status of the *Cart* LED (whether it is off, on or flashing), along with the display, tells you where you are at any given time. Press *Sounds*. Then:

- To select internal sounds, the *Cart* LED should be off (unlit). If it is on or flashing, press *Cart* until it is off. The display indicates INT followed by the bank # in the upper left corner.
- To select ROM sounds, double-click the *Cart* button (press the button twice in rapid succession). The *Cart* LED *flashes*, and the display indicates ROM followed by the bank # in the upper left corner.
- To select cartridge sounds, press the *Cart* button once. The *Cart* LED lights, and the display indicates CRT followed by the bank # in the upper left corner. (Note that a VPC-100 series or other cartridge must be inserted before cartridge sounds can be selected and played.)

## Hint:

Because you can use the *Cart* button and the ten Bank buttons to "shop around" in various banks before selecting a sound, it is possible to lose track of where the currently selected sound (the one you are hearing) is located. There is a shortcut for getting to the bank that contains the selected sound:

- Rapidly double-click the *Sounds* button to instantly go to the bank which contains the currently selected sound.

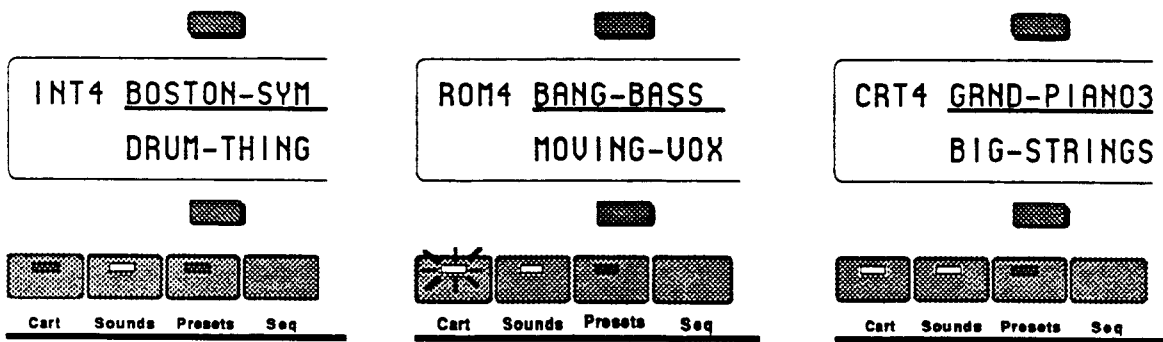

When the Sounds LED is *on* and the Cart LED is *off*, the VFX-SD is playing programs from its internal RAM memory. The upper left corner of the display shows INT plus the bank number (0-9).

When the Sounds LED is *on* and the Cart LED is *flashing*, the VFX-SD is playing programs from its internal ROM memory. The upper left corner of the display shows ROM plus the bank number (0-9).

When the Sounds LED is *on* and the Cart LED is *on* (but not flashing) the VFX-SD is playing programs from the cartridge. The upper left corner of the display shows CRT plus the bank number (0-9).

Once you have selected INT, ROM or CRT, select a sound using the ten bank buttons and the six soft buttons above and below the display as shown previously.

### Layering (stacking) a sound with the selected sound

To layer (or stack) any program with the currently selected program, *double-click* the soft button corresponding to the sound name on the display. The underline beneath the name of the layered sound will *flash* and you will hear both sounds playing together.

Up to three programs (one selected and two layered with it) can be active at once. To deselect a layered sound, press its button again and the flashing underline will disappear. If you already have two programs layered with the primary program, and you double-click on a fourth sound, that sound will replace the most recently layered sound in the stack.

You can layer any combination of Internal, ROM or Cartridge sounds. Also, the sounds which are layered do not have to be in the same bank.

### Primary sound vs. layered sounds

We refer to the sound which is currently selected — solidly underlined on the display — as the *primary* sound. Any other sounds on which you double-click are considered to be *layered* with the primary sound. Only one sound is ever *selected* at a time. Whenever you select a new sound *it* becomes the primary sound.

This is an important concept because the primary sound determines which Effects set-up will be used for layers and presets. Whenever you select a new primary sound, a new effects algorithm is loaded along with it (unless the new sound has the same effect as the previous one). Layering a sound or selecting a different sound within a preset does not change the current effects setup.

## About Tracks

From the player's perspective, there are two main performance modes in the VFX<sup>SD</sup> - *Preset mode* and *Sequencer mode*. There are a few concepts that need to be established before we can clearly describe the features of these two modes.

In the VFX<sup>SD</sup>, the term *track* refers to one of the fifteen internal "channels" (27 in song mode), each of which contains a program and a complete set of performance parameters, including volume, pan, controller settings, MIDI channel, keyboard zone, and others. There are three tracks in a preset, 12 in a sequence or song. The only real difference is that you can record data on sequencer tracks and not on preset tracks.

Multi-channel audio tape recorders have numerous physical tape tracks onto which you can magnetically record complex polyphonic information. Sequencers simulate this by recording events which describe a performance onto virtual tracks in computer memory. When these sequence tracks are played back, the recorded information can play local sounds or can be sent to remotely controlled sound generators to recreate the performance. Multi-timbral instruments can respond to inbound information from such sequencers on multiple channels, with each channel responding to a track from the sequencer.

When the VFX<sup>SD</sup> is used as a multi-timbral sound generator, played from its own sequencer, the various tracks of the sequencer control the sounds played by the VFX<sup>SD</sup>. Similarly, the sequencer or the keyboard of the VFX<sup>SD</sup> can be used to send on MIDI channels to which external devices are connected.

When the VFX<sup>SD</sup> is controlled from an external MIDI sequencer, the various tracks of the sequencer can be assigned to different MIDI channels, which in turn control the programs played by the VFX<sup>SD</sup>. Each MIDI channel to which the VFX<sup>SD</sup> responds can be thought of as an extension of the sequencer's track.

Whether it is playing locally, sending MIDI to a remote device, or receiving MIDI from an external sequencer, we describe this logical construct, comprised of a MIDI channel and a program and various performance parameters, as a track.

### Preset Mode vs. Sequencer Mode

A *preset* is a set of three tracks, which can be layered or not, each of which has a program and a set of performance parameters associated with it.

The most common context for the VFX<sup>SD</sup> to be in is *Preset mode*. Unless the VFX<sup>SD</sup> is in sequencer mode (that is, if either the *Sounds* or the *Preset* LED is lit), you may assume that you are in a preset. Aside from the presets that are saved, there is a non-volatile *preset buffer* that is always active.

Whenever you select or layer or edit a program, you are working within this preset buffer. The information in the preset buffer is temporary until you save it into one of the internal or cartridge preset locations, and then it becomes more permanent (it can be recalled). The performance parameters of the preset, including volume, pan, transpose, etc. are always active and you should make sure that their settings are correct if you think that your programs are behaving strangely. Whenever you select a new program from the Program Bank pages, the performance parameters are reset to their standard default settings. If you wish to change a program without resetting these parameters, use the Replace Program feature described later in this section.

There are three tracks in a "normal" preset and twelve in the a sequence or song. A sequence, in addition to its ability to record data on its tracks, can be thought of as a giant twelve track preset. However, this giant preset is not available simultaneously with normal three track presets. The twelve tracks of a song or sequence are available from the keyboard only while in Sequencer mode, indicated by the LED in either the *Tracks 1-6* or *Tracks 7-12* button being on, or from MIDI while the MIDI mode is set to MULTI. Use of the sequencer is described in more detail later in this manual.

**About Presets**

A *Preset* is a combination of three sounds and an effects set-up which can be instantly recalled for use in performance. Presets are handy "performance memories" which allow you to create and save sound combinations, splits, layers, patch select variations, etc.

The three sounds in a preset reside on three *Tracks*. For each of these three tracks, the VFX<sup>SD</sup> remembers:

- Which sound is assigned to the track
- Whether the sound is selected, layered or neither, and
- The values of all the Performance parameters for that track.

A preset also has one Effects program which is common to all three tracks.

Press *Presets*. The LED in the *Presets* button lights, indicating that you are in Preset mode. Across the top line, the display shows the names of the three sounds that are on the three tracks. On the lower line you see "context" information about the current preset. The illustration below shows the relationship of the preset and its three tracks to what you see on the display:

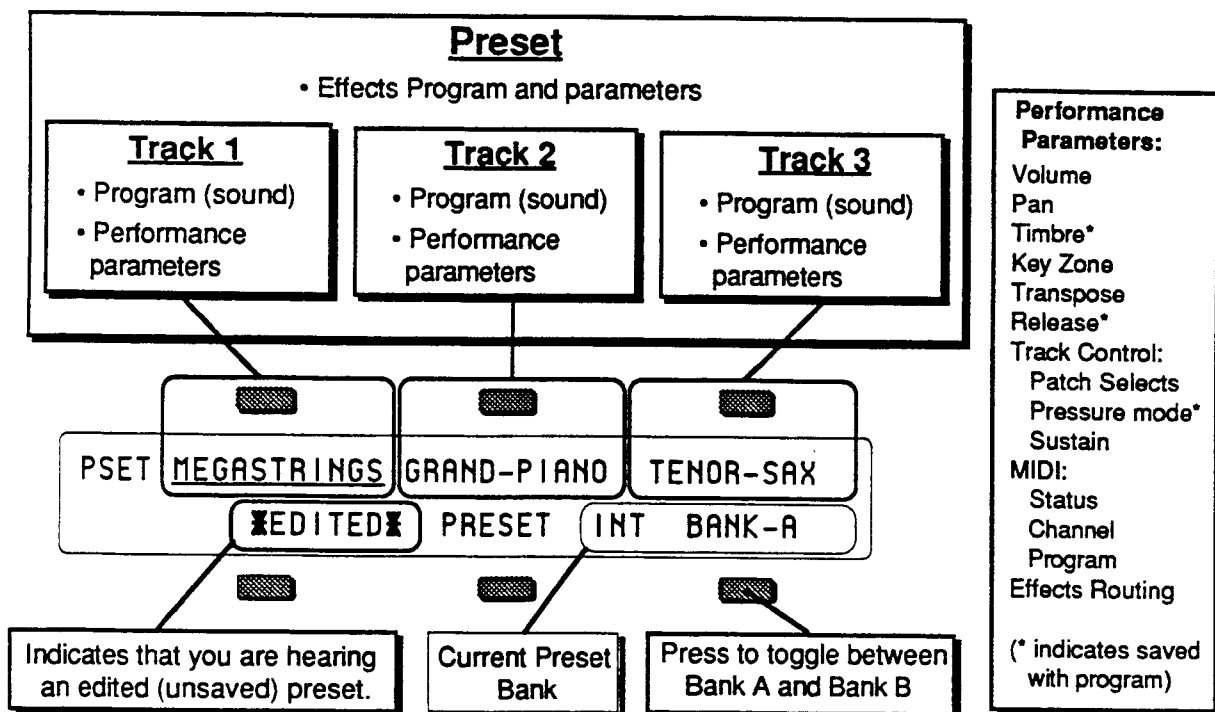

Whenever the *Presets* LED is lit, this indicates that the VFX<sup>SD</sup> is in Preset mode, and the 10 Bank buttons beneath the display will now select presets (rather than selecting Program Bank pages, as they do when the *Sounds* LED is lit).

## Preset Memory

Presets are located in one of three places within the VFX<sup>SD</sup> memory:

- INT — 20 presets in the Internal memory, 10 in Bank A and 10 in Bank B.
- ROM — 20 presets in ROM Memory, 10 in Bank A and 10 in Bank B.
- CRT — 20 presets in each cartridge, 10 in Bank A and 10 in Bank B.

## Selecting Presets

Once you have pressed the *Presets* button to enter Preset mode, presets are selected by pressing the 10 bank buttons beneath the display. The status of the LED in the *Cart* button determines whether the 10 bank buttons select Internal, Cartridge or ROM presets.

The Bank Indicator in the lower right corner of the the display tells you whether you are selecting presets from Bank A or Bank B. Pressing the soft button beneath the bank indicator (or double-clicking the *Presets* button) toggles between Bank A and Bank B.

- To select internal presets, the *Cart* LED should be off. If it is on or flashing, press *Cart* until it is off. The display indicates INT + BANK A or B
- To select ROM presets, double-click the *Cart* button (press the button twice in rapid succession). The *Cart* LED flashes, and the display indicates ROM + BANK A or B
- To select cartridge presets, press the *Cart* button once. The *Cart* LED lights, and the display indicates CRT + BANK A or B.

Once you have selected Internal, ROM or Cartridge, simply press one of the 10 bank buttons to select a preset. The LED in the bank button lights to indicate which preset is selected.

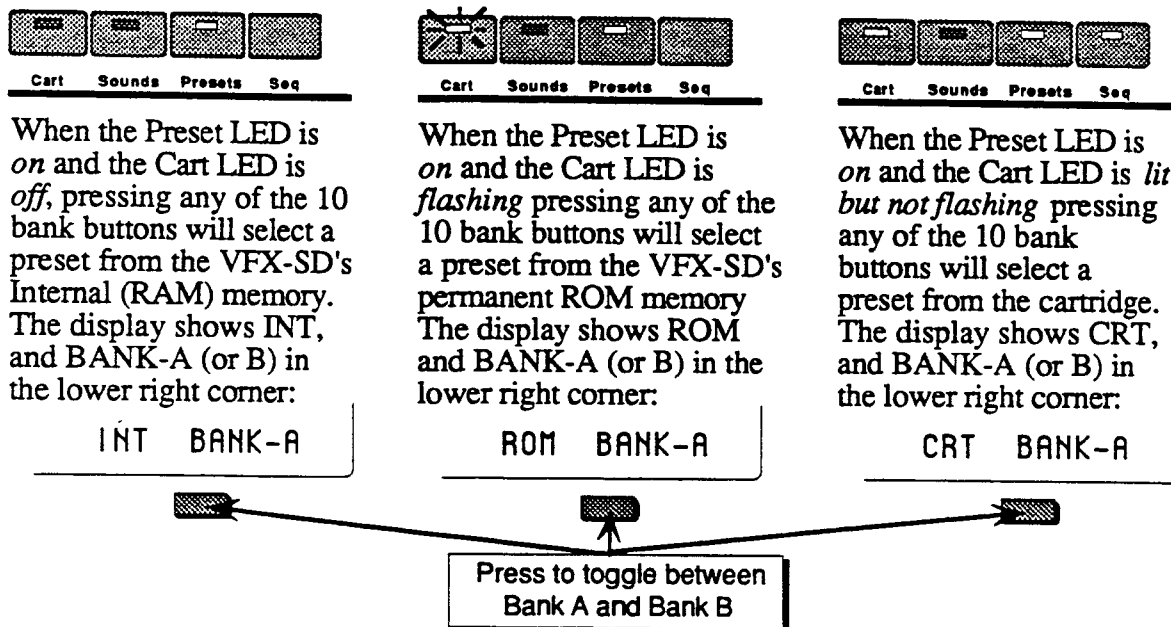

## Editing a Preset

In addition to the presets stored in memory, there is one more preset which you are using most of the time whether you know it or not. Whenever you are selecting or layering sounds in Sounds mode, you are also creating a preset. The

VFX<sup>SD</sup> automatically "remembers" the last three sounds you selected and stores them in a special memory buffer called the *Edit Preset*.

Try this:

- Press *Sounds* and select a program by pressing its soft button.
- Layer another sound with the first by double-clicking its soft button.
- Layer a third sound by double-clicking on it.

You now have three sounds playing simultaneously. Suppose you wanted to adjust their relative volumes, or shorten the release time, or change the pan location of one of the sounds without losing the combination. In fact, you can do these things and a lot more with presets.

As we have already discussed, a preset consists of three tracks, each of which has a program and a set of performance parameters. The performance parameters are found in the Performance section of the front panel. Presets can be saved, so that you can call them up at any time, or you can use the Edit Preset in real time as a powerful performance tool.

While you still have three programs layered, press the *Volume* button in the Performance section. The display shows:

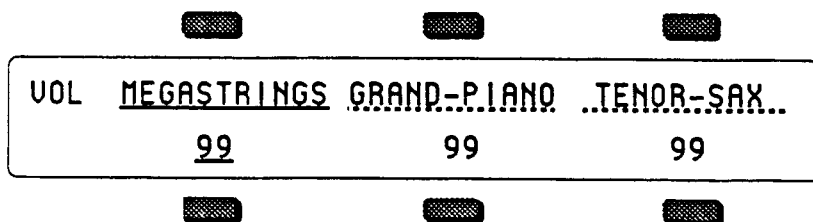

- Across the top line you see the three programs you selected, one with a solid underline and the other two with a flashing underline, just as they appeared on the program bank pages.
- On the lower line you see the volume levels for each sound. You can select which one you want to adjust by pressing the button beneath the value.
- Note that you can select a track for editing (using the lower three buttons) independent of what is selected or layered on the upper line of the display. This means, for example, that you can adjust the volume of any of the three sounds in the stack without having to un-layer them.

On this and all Performance parameter pages, selecting or layering things from the upper line determines what sound(s) you *hear*, and selecting things from the lower line determines which track will be modified if you move the data entry slider or the up/down arrow buttons.

Try pressing some of the other Performance page buttons — *Pan*, *Timbre*, *Key Zone*, etc. — and adjusting the Performance parameters on those pages. You will soon see that within a preset it's easy to create splits and layers, transpose a sound, change the pan and many other useful things. You can even assign one or more tracks in a preset to play *only* over MIDI, making presets a great for controlling remote MIDI instruments as well as VFX<sup>SD</sup> sounds.

Section 3 of this manual entitled "Performance Parameters" covers these functions and their use in detail.

### Saving a Preset

Once you have created a preset you like, you can save it to one of the 20 Preset locations in the internal memory or to a cartridge. (Note that you cannot save presets or sounds to the ROM memory — it is *read only*.) Saving a preset to an internal or cartridge location will *erase* the one that is there, so be careful.

To save a preset, decide where you want to save it, then:

- Press *Presets*.
- Select Internal (INT) or Cartridge (CRT) using the *Cart* button.
- Select Preset Bank A or B by pressing the soft button beneath the Bank indicator in the lower right corner of the display.
- Press and hold down the *Presets* button. The *Presets* LED flashes, and the word SAVE flashes in the lower left corner of the display.

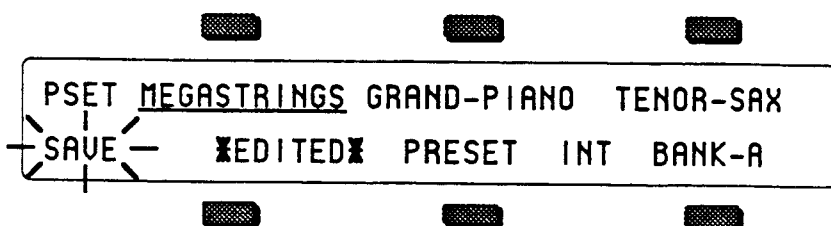

- While holding down *Presets*, press one of the ten bank buttons. The Edit Preset is saved into that location:

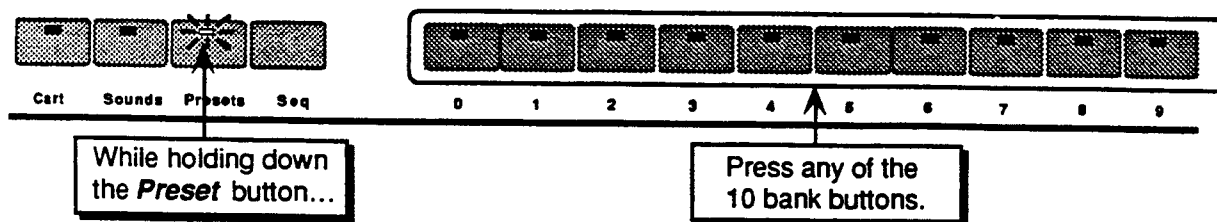

If you need to listen to a few presets in order to decide which one to replace, simply press *Presets* and then select presets just as you normally would, by pressing the bank buttons. The word *\*EDITED\** disappears from the screen, meaning that you are listening to saved presets. Your new preset is safe in its own edit memory. But make sure you don't change *anything*, including selecting or layering sounds, in any of the presets you audition, or this will create a new Edit Preset, erasing the one you created.

When you are ready to save the new preset, press the bank button of the currently selected preset. Its LED turns off, and you are returned to the Edit Preset (the word *\*EDITED\** should return on the display). Now you can save the preset as described above.

### Avoiding confusion when using Presets

Whenever you create and save a preset, the VFX<sup>SD</sup> only "remembers" the *location* of the three sounds in internal or cartridge memory — not the actual programs themselves. If you move a program, put another in its place, or transfer an entire bank of sounds, the preset might still be "pointing to" a location that no longer contains the sound you had in mind.



For example, if you create and save a preset containing a brass sound, a string sound and a piano sound, and you then write over the piano program (or insert a different cartridge, in the case of presets containing cartridge programs) a different sound will now appear in place of the piano sound — whatever is now in the location originally occupied by the piano sound.

If one or more of the sounds in a preset is a cartridge program and you remove the cartridge, the words **CART-SND-##** will appear instead of the program name, and the sound that plays will be the internal program with the same relative memory location (until you replace the cartridge).

This leads us to one very important piece of advice:

- *You should use only internal and ROM sounds in presets saved to internal memory, and use only cartridge and ROM sounds in presets saved to a cartridge.*

It is possible, of course, to mix internal and cartridge sounds in a single preset, but we recommend that you avoid doing so, as it will definitely lead to confusion when the cartridge is changed or new sounds are loaded into the internal memory.

### Replace Program

The Replace Program function is primarily used for:

- Assigning programs to tracks without changing the effects or other performance parameters
- Determining the exact placement of programs in a preset

Normally, when programs are selected from the program bank pages, they are transferred to a track in the current preset and many of the performance parameters for that track are reset to standard default settings. However, you may wish to change which program is assigned to a track in a preset (or in a sequence) without changing any of the other settings for that track. This is done using the Replace Program feature. The **Replace Program** button is located next to the **Tracks 1-6** and **7-12** buttons on the bottom row in the Performance section.

### Replacing a program in a Preset

- Press one of the Performance parameter buttons, such as **Volume**, to display the current preset, and make sure that the correct track is selected. The track whose program will be replaced is indicated by the underlined parameter on the lower line of the display. It does not matter which type of parameter is displayed. Use the three soft buttons below the display to select the correct track.
- Press the **Replace Program** button. The last selected program bank page will be displayed and the LED in the **Sounds** button will start to blink, indicating that you are in Replace Program mode.
- Locate the program that you wish to install into the track and press the soft button nearest to it. This program is now installed on the track, and will acquire the status of the program that was replaced if it was selected or layered. You may change banks and/or continue to select replacement programs until you are satisfied that you have found the right one. If you select a program for a track which is not currently selected or layered in the preset, you will be immediately returned to the preset page you were on.

- Press **Replace Program** again to exit Replace Program mode and return to the preset page to verify that your change was correct. Pressing *Sounds* or any other page button will also exit Replace Program mode.

The method described above is also used for changing the program assigned to a track in the current sequence or song.

### Replacing a Program and the Effect in a Preset

You can replace the program on a track *and* make its effect become the preset's effect by adding one step to the Replace Program procedure:

- Select a preset and select the track whose program you want to replace.
- Press and hold **Replace Program**.
- While holding down **Replace Program**, press the **Performance Effects** button.
- Use the Bank buttons and the soft buttons to pick a sound as before; but now each time you pick a new sound its effect will become the preset effect.
- Press **Replace Program** again to exit Replace Program mode and return to the preset page to verify that your change was correct.

### Performance Tip — Creating Keyboard splits

One of the most common usages of presets is a keyboard split, in which your left hand plays an "accompaniment" sound and your right hand plays a "solo" sound. This is easy to set up on the VFX<sup>SD</sup> by layering the two sounds and assigning them different key zones. You can save this arrangement as a preset so that any time you select that preset, you'll recall the keyboard split.

Since presets can hold three sounds, you can add another "solo" sound by layering it (double-click) and then setting its key zone. Once you have a preset with a split and two different "solo" sounds, it's possible to switch back and forth between "solo" sounds with one button press. First, select (single-click) one of the "solo" sounds. Then, layer (double-click) the "accompaniment" sound. Now, you can switch between "solo" sounds by selecting the unused solo sound. The layered sound will not be turned off, since it's not "covered up by either of the selected sounds.

Since each track in the keyboard split has its own Transpose value, you are not limited to bass notes on the piano just because it's on the bottom of the keyboard. Just set the key zone to the keys you want to play and then transpose the sound up or down until it's playing in the range you want.

Once you have a keyboard split, you can change any of the sounds without affecting the split points by using the **Replace Program** button (see "Replace Program," above).

### Section 3 — Performance Parameters

- provide easy access and control for track and sound attributes
- are used in mixing/manipulating sequencer tracks and in creating presets

About Performance Parameters . . . . .	3 - 1
Volume Page . . . . .	3 - 2
Pan and Timbre Pages . . . . .	3 - 3
Key Zone Page . . . . .	3 - 4
Transpose Page . . . . .	3 - 5
Release Page and Track Control . . . . .	3 - 6
Patch Select Page . . . . .	3 - 7
Pressure Page . . . . .	3 - 8
Sustain Page . . . . .	3 - 9
MIDI Status Page . . . . .	3 - 10
MIDI Channel Page . . . . .	3 - 11
MIDI Program Page . . . . .	3 - 12

#### About Performance Parameters

A group of Performance Parameters is associated with each preset and sequencer track. These parameters control various aspects of the track, including some important and useful sound controls which may be easily adjusted during performance or recorded into the sequencer. The settings of these parameters are saved with every preset. These instantly recallable presets include an effect setup and three programs on three tracks with a full set of programmable performance parameters, including key zones, transpositions, release times, timbral variations and others. The settings of all performance parameters on sequencer tracks are saved for each track while the power to the VFX<sup>SD</sup> is off, and are always available.

The buttons which control the pages containing these parameters are found in the Performance section of the front panel.

The Performance/Track Parameters are:

VOLUME	overall volume adjust
PAN	stereo panning control for track program
TIMBRE	programmable sound variation control
KEY ZONE	set key zone ranges
TRANSPOSE	key number transposition
RELEASE time	program release time adjust
Track Control	PATCH SELECT default setting of Patch Select control
	PRESSURE type selects type of pressure used
	SUSTAIN enable enables or disables the sustain pedal
MIDI	STATUS enable or defeat MIDI function
	CHANNEL MIDI channel number
	PROGRAM MIDI program number
EFFECT	FX controls routing of track to effect
	Select and Mix effect control for presets or sequences
	Parameter 1 effect parameter page 1
	Parameter 2 effect parameter page 2

To view or adjust the setting of a particular type of performance parameter, press the appropriate button in the Performance section. The selected parameter type is indicated in the top-left corner of the display.

On the Preset pages, the top line of the display will show the names of three programs and their current layering status. The name of the parameter type is abbreviated to four characters in order to make room for the program names, and is shown in the top left corner of the display. The bottom line of the display shows the current values of the selected parameter for the three tracks of the preset.

In Sequencer mode the current values of parameters for the six tracks (Tracks 1-6 or 7-12) will be displayed. Except in the cases of performance parameter buttons with sub-pages, you can press the parameter page button again to toggle back and forth between the TRAX page which shows the names of the programs on the tracks and the parameter page which shows parameter values. The Tracks 1-6 and 7-12 buttons will also perform this toggling function.

The currently selected track parameter will be underlined. This is the active parameter which can be modified. You may select a parameter for a different track by using the soft buttons. When programming performance presets, the lower row of soft buttons is used to select tracks. For sequencer or song tracks, both upper and lower row of soft buttons are used.

Remember that you can edit parameters on tracks that you are not hearing. The tracks that you can hear are indicated with solid or flashing underlines on their names.

Unless otherwise noted in the detailed descriptions which follow, use the increment/decrement buttons or the data entry slider to adjust the value of the parameter.

## Volume Page

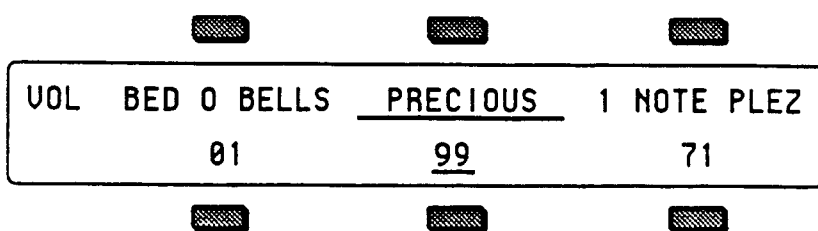

The Volume Page enables you to make volume changes to the individual tracks, allowing you to balance the VFX<sup>SD</sup> sounds and/or control the volume of external MIDI devices. In sequencer mode, the Volume page has a special function which allows you to click or double-click on specific tracks to mute or solo them during playback of sequences or songs (see Section 5 for more).

Range: 0 to 99.

All tracks whose MIDI Status is set to MIDI or BOTH will send a MIDI Volume Change message (controller 7) with the indicated value whenever this parameter is edited. Sequencer and preset tracks will also send the current volume for each track when a sequence or preset is selected.

## Pan Page

PAN	BED 0 BELLS	<u>PRECIOUS</u>	1 NOTE PLEZ
	VOI	<u>+99</u>	+45

The Pan Page gives you control over the placement of the track's sound in a stereo field.

When a track is set to VOI, which is an abbreviation of VOICE, the voices of a program are panned according to the settings originally programmed on the Output page for each voice. Setting this parameter to any other pan value will override the original settings and will force ALL of the voices of the program to be panned to that location.

Range: +00 (hard pan left) to +99 (hard pan right). A setting of +50 places the sound in the center of the stereo field. The minimum setting is VOI which indicates that the individual voice's pan settings will be used.

## Timbre Page

TIMB	BED 0 BELLS	<u>PRECIOUS</u>	1 NOTE PLEZ
	67	<u>76</u>	23

The Timbre parameter provides an easy way to make useful changes to the character of a sound without getting into more complex programming. This performance parameter uses the data entry slider or up/down arrow buttons to control various aspects of the sound, depending on the what the programmer has decided would be useful.

As one of the voice modulation sources, TIMBRE can be assigned to anything that can be modulated in a program or effect. The Timbre control can be connected to parameters such as filter cutoff, waveform modulation, LFO rate, and others. It is a good idea to experiment with the Timbre setting to hear what it has been programmed to do in each program.

Range: 00 to 99

All tracks whose MIDI Status is set to MIDI or BOTH will send a MIDI Continuous Controller message (controller 71) with the indicated value whenever this parameter is edited. Preset tracks will also send this controller message when a preset is selected.

The current value of TIMBRE is saved with the program whenever a program is written, and is restored whenever the program is selected or placed on a track.

## Key Zone Page

ZONE	..... CELLOS .....	..... PIANO .....	..... FLUTE .....
	C2 -D3	B2 -B4	D4 -C7

Each track has its own independent Key Zone within which the track will play. Key Zones can be used to create simple two-program splits, or to create more complex keyboard layouts. Key Zones control which keys will be sent out via MIDI as well as which keys will play on the local voices of the VFX<sup>SD</sup>.

You can divide the keyboard into as many as twelve different key zones by using the twelve sequencer tracks. In addition, you can set the key zone so that each zone overlaps the next, producing "layered" zones in which you would hear the sounds from more than one track. Range: A0..C8

The illustration below shows an example of three tracks with overlapping key zones. The Piano is layered with, and partially overlaps, the Cellos on the lower end and the Flute on the upper end. The Key Zone settings for this example are shown in the sample display above.

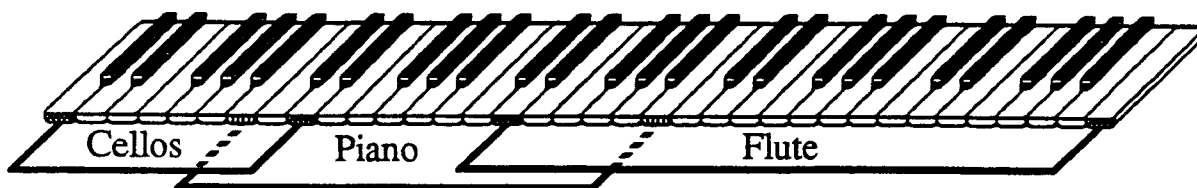

## Setting the Key Zone

Unlike other performance parameter pages, the normal state of this page is to have no parameter fields underlined.

In order to set a Key Zone:

- Select the track by pressing the soft button nearest the zone you wish to set. This will result in the Low Key of the zone (the left key number) becoming underlined.
- Play the key on the keyboard which you want to be the *lowest* key of the zone. The underline will automatically move to the right for the High Key of the zone.
- Play the key for the *highest* key of the zone. The new values for the zone will be displayed and the underline will disappear.
- If you wish to change the zone, simply repeat the process.

The key zone is automatically reset to full range whenever you select a program from one of the Program Bank pages. When you select a program using the Replace Program feature, the key zone setting is left unchanged.

Changing the key zone will *not* affect the playback of sequencer tracks (though it does affect what is recorded). Sequencer tracks will play all keys that were recorded, regardless of the key zone at the time of playback. To eliminate a key range from a track, use the Erase function on the Edit Track page (Section 12).

**Warning:** If the key zone is accidentally set to a range where the High Key is actually *below* the Low Key, then the track will not play. To correct this situation, you can re-program the zone manually or you can reselect the program from the program bank page, which will automatically reset the key zone to full range.

## Transpose Page

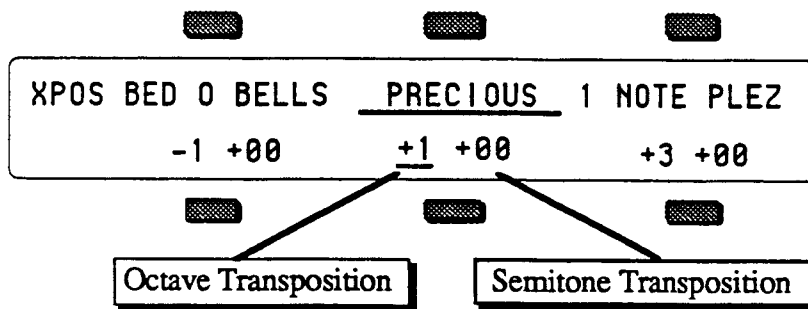

Each track can have its pitch transposed (raised or lowered) by octaves and semitones within an eight octave range. The transpose setting affects both the pitch played by Local VFX<sup>SD</sup> voices and the key number transmitted via MIDI (if the MIDI Transpose enable parameter is ON on the MIDI Control page.)

Pressing the soft button for an already selected track will toggle the underline (showing the active field) from octave to semitone and back.

Ranges: Octave parameter            -4 to +4 octaves  
           Semitone parameter        -11 to +11 semitones\*

\* It is possible to extend the transposition outside of the normal range by using the up and down arrow buttons to edit the semitone value to a maximum of + or - 8 octaves and 11 semitones, although this may cause unexpected results.

In Sequencer mode, the Transpose function provides a way to transpose tracks in real time without changing the data in the track. However, you should take care never to transpose a track whose status is MIDI or BOTH while holding keys down or while the sequencer is running. This could cause the key-up events to be missed by the receiving device, causing notes to "hang."

## Release Page

RELS	BED	0	BELLS	<u>PRECIOUS</u>	1	NOTE	PLEZ
			-28	<u>+50</u>			+00

The Release Page enables you to increase or decrease the release time of the program on a selected track. (Release time is the time it takes for the sound to fade away when the key is released). This is useful when you need to adjust the release characteristics of a sound for a particular application without getting more deeply into programming.

In order to be controlled by this performance parameter, one or more of the envelopes in the program must be programmed with the Envelope Release Time parameter set to a value with a star ( \* ) suffix. For example, if ENV3 - TIMES - RELEASE=50\* instead of simply 50, then the release time of envelope 3 can be adjusted from the Performance Release parameter. It is typical to have at least Envelope 3 controlled by the parameters on this page.

Range: -64 to +64      Higher values lengthen release time.  
 Lower values shorten release time.

All tracks whose MIDI Status is set to MIDI or BOTH will send a MIDI Continuous Controller message (controller 72) with the indicated value whenever this parameter is edited. Preset tracks will also send this controller message when a preset is selected.

The current value of RELEASE is saved with the program whenever a program is written, and is restored whenever the program is selected or placed on a track.

## Track Control Parameters

The three parameters grouped together under the *Patch Select* button control several performance aspects of the track:

PATCH SELECT  
 PRESSURE  
 SUSTAIN

The button name is *Patch Select* because the top page contains the default Patch Select setting, and this is an important feature of the VFX<sup>SD</sup>. The following two sub-pages contain Pressure mode and the Sustain enable switch. These sub-pages are accessed by repeated presses of the *Patch Select* button.



## Patch Select Page

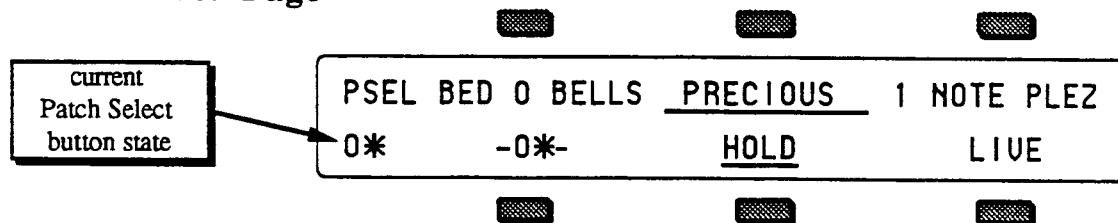

This Page gives you control over the Patch Select buttons assignments for each track.

<u>Setting</u>	<u>Patch used by track</u>
LIVE	uses the current state of the buttons to select a patch
-00-	always uses the 00 patch
-0*-	always uses the 0* patch
-*0-	always uses the *0 patch
-.**-	always uses the ** patch
HOLD	uses the patch set by the first key hit while touching the patch buttons

The HOLD setting is special because it lets you easily hold a patch select variation by playing a key on the keyboard while touching the patch select button(s). The first key you play after touching the patch select buttons will hold that patch select variation as the current patch for the track. You may then continue to play without having to touch the patch select buttons, which makes two-handed playing easier. If you wish to return to the 00 patch, touch either of the patch select buttons and release it *before* you play the next note. This will hold the 00 patch.

When programming patch variations, you can set the mute status of the various voices in different patches without leaving the Select Voice page by using the HOLD feature.

## Latching Patch Selects

Latching is more permanent than holding because once latched, the patch will remain assigned to the track even if the patch select buttons are touched again later.

While the Patch Select page is being displayed in either Preset or Sequencer modes, it is possible to instantly "latch" the current state of the patch select buttons into a track by pressing the soft button for the currently selected track. If neither of the patch select buttons are being held down when this function is performed, the parameter setting will revert to LIVE status. If you wish to set the status to 00, then use the up/down arrow buttons to change the fixed setting. To latch the patch select setting for a different track, first press the soft button to select the track, then press it again while holding one or both patch select buttons to latch the setting.

For more information on programming uses of the Patch Selects refer to the Programming Section of this manual

## Pressure Page

PRES	<u>BED OF BELLS</u>	TIMBRE	ORG 1	NOTE	PLEZ
	NONE	KEY		CHAN	

The Pressure sub-page enables you to assign one of three pressure modes to each Track.

- **NONE**—Pressure information will not be sent over MIDI or recorded by the sequencer, nor will the program on the track respond to pressure locally.
- **KEY**—This setting enables the track to send and receive via MIDI the most expressive kind of pressure—Poly-Key pressure. ENSONIQ's exclusive Poly-Key pressure lets you add pressure modulation to each note independently. If you press down on any particular key within a chord, only that note will be affected by pressure—all others remain unaffected. When a sequencer track is set to KEY, Poly-Key pressure will be recorded into the track, even if the sound is not programmed to respond to it. See the warning below about conserving sequencer memory.
- **CHAN**—This enables the track to send and receive via MIDI the most common type of pressure—channel pressure. With channel pressure, after a note is played, pressing down harder on a key modulates *every* note currently playing. Like a mod wheel, channel pressure is "global," it affects the entire keyboard when activated. When a sequencer track is set to CHAN, Channel pressure will be recorded into the track.

You should consult the MIDI implementation chart of the MIDI device you will be using in conjunction with the VFX<sup>SD</sup> to see which (if any) type of pressure it responds to and transmits. For best results, set the VFX<sup>SD</sup> Pressure parameter to match the type of pressure supported by the external MIDI device which will send to or receive from the track you are setting.

The current PRESSURE setting is saved with the program whenever a program is written, and is restored whenever the program is selected or placed on a track.

**WARNING:** If a sequencer track is set to KEY or CHAN, the sequencer will always record pressure into the track. Pressure (especially Poly-key pressure) is recorded by the sequencer as a steady stream of numbers, and you will use up the sequencer memory at an alarming rate if pressure is enabled. For this reason, you should always be aware of the setting on this page when you go to record or overdub a track. If the track doesn't call for pressure, set this control to NONE. This will avoid wasting valuable sequencer memory and also avoid clogging up the MIDI "airwaves" with a lot of unnecessary pressure information. Existing pressure information can also be removed from a track using the Filter command on the Edit Track page.

## Sustain Page

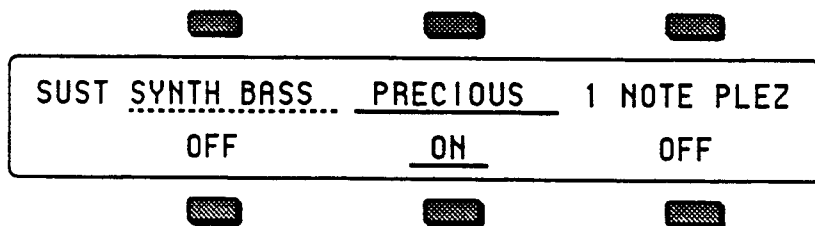

The Sustain sub-page allows you to determine whether each of the individual tracks will respond to sustain controller events. The effect of all sustain events, whether from the VFX<sup>SD</sup> sustain pedal (FTSW 2=SUSTAIN on the Master page) or sustain commands received from MIDI, is controlled by this switch. There are two setting for this switch, ON and OFF.

- ON sustain events will affect all notes played within the active key zone for this track.
- OFF sustain events will have no effect on the notes played on this track.

For example, as shown in the screen above, it may be useful to turn off sustain events on a track set up as a bass sound in a split keyboard configuration. This allows you to play staccato bass lines on the lower part of the keyboard while playing chords on the upper part of the keyboard and using the sustain pedal. The bass notes will not be affected by the sustain pedal because the track is set to OFF, but the chords will sustain.

## Using Effects With Performance Presets

All three tracks in a preset, and all the tracks in a given sequence or song, share the same effects program. The effects program for the preset is inherited from the primary (non-layered) selected program and any layered programs in the preset will use that same effect. The effects program for the sequence or song is inherited from the current sequencer effect at the time the sequence or song was created. If this effect is incompatible with other programs in the preset sequence or song, there are several options:

- set the effects routing to DRY for any of the programs which are incompatible;
- set the routing to AUX for programs which you want to process separately by sending them to the Aux Outputs; and/or
- change the preset/sequencer effect to be something more suitable.

When you press the Performance *Effect* button from preset or sequencer mode, the first page that appears is the Track Effects Control page. On this page you can override the normal effects routing of the program for each track. Subsequent sub-pages let you redefine the effect for use in the Preset, sequence or song, and are identical to the effects programming pages in the Programming section (see the Effects section for more information on effect selection and programming).

## Performance MIDI Parameters Page

The parameters on the Performance MIDI page control the MIDI attributes of each track. On this page, you can determine:

- The MIDI STATUS of the track (i.e. whether it will play locally, only over MIDI, or both);
- The MIDI CHANNEL on which the track will transmit and receive;
- The MIDI PROGRAM NUMBER which the track will transmit when selected.

The Performance MIDI page consists of three separate sub-pages. Each time you press the **MIDI** button in the Performance section, the next sub-page will be displayed. On Preset pages, the parameter name will be abbreviated as follows:

STAT	MIDI Status
CHAN	MIDI Channel
PROG	MIDI Program number

Press **MIDI** to show the first sub-page:

### MIDI STATUS

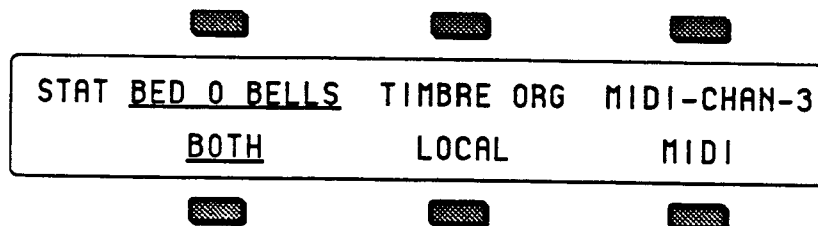

This page determines the MIDI Status of a track. The four possible settings are:

- **BOTH** Keys, controllers, etc., will play locally *and* will be sent via MIDI over a selected MIDI channel. Incoming MIDI will play internal voices.
- **LOCAL** The track will only play internal voices, and will not send any data out MIDI. Incoming MIDI will play internal voices.
- **MIDI** Keys, controllers, etc., will be sent out via MIDI when the track is played from the keyboard. However, keys played or recorded on the track will not play VFX<sup>SD</sup> voices at all. Incoming MIDI *will* play internal voices. This is comparable to Local Off on some keyboards. Use this status when you want to create MIDI-only tracks for sequencing or playing remote MIDI devices. When MIDI status has been selected for a track, instead of showing the program name, the display will show \*MIDI-CHAN-#, indicating its status and what MIDI channel it is sending on (assuming the MIDI-TRK-NAMES switch on the MIDI Control page is OFF; see Section 6).
- **\*EXT\*** Same as MIDI status except that incoming MIDI *will not* play internal voices. This is useful when using the VFX<sup>SD</sup> as a controller with an external sequencer and a number of other MIDI sound modules. It is also good for turning off certain tracks when using the VFX<sup>SD</sup> as a

multi-timbral receiver in Multi Mode, thereby limiting the number of channels to which the VFX<sup>SD</sup> will respond. See Section 13 for more on both of these applications.

The chart below details the behavior of sequencer tracks for each status:

Track Status =	BOTH	LOCAL	MIDI	*EXT*
Playing the keyboard plays local voices	Yes	Yes	No	No
Playing the keyboard sends out MIDI	Yes	No	Yes	Yes
Playing the sequencer track (pressing Play) plays local voices	Yes	Yes	No	No
Playing the sequencer track (pressing Play) sends out MIDI	Yes	No	Yes	Yes
Incoming MIDI data plays local voices	Yes	Yes	Yes	No

Press *MIDI* to show the second sub-page.

**MIDI CHANNEL**

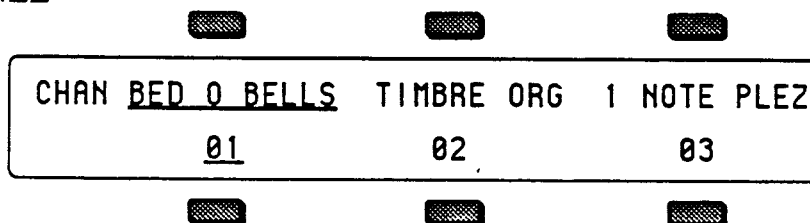

Use this sub-page to determine which MIDI channel a Track will use to transmit and receive data. The differences in how this parameter controls the track for transmitting and receiving are important to understand and are described below. You may also wish to refer to the sections covering the MIDI Control page, and the Sequencer Applications section.

**Transmit** Controls which channel the the three tracks of a preset will *send* data on only if SEND-CHAN=TRACK is selected on the MIDI Control Page. Otherwise, in Preset mode, the VFX<sup>SD</sup> keyboard will send only on the base MIDI channel no matter which preset track is selected. Sequencer tracks which have MIDI, BOTH or \*EXT\* Status will *always* send only on the MIDI channel defined on this page.

**Receive** Controls which channel an individual sequencer track will *receive* data on if MIDI MODE=MULTI or MONO B mode is selected on the MIDI Control Page. In POLY or MONO A modes the VFX<sup>SD</sup> will receive only on the base MIDI channel no matter which track, program or preset is selected. Individual preset tracks will *not* receive on different MIDI channels; for presets this is a send-only function.

Range: MIDI channels 1 through 16.

Press **MIDI** to show the third sub-page:

### MIDI PROGRAM Number

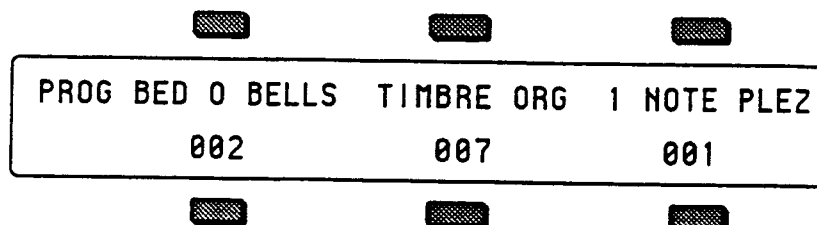

Range: 001 through 128 (MIDI program numbers 0 to 127)

This sub-page lets you choose which MIDI Program Change number will be sent via MIDI when the track is selected. If the track MIDI status has been set to LOCAL, the track will not send program changes.

The number which appears is usually the number of the internal VFX<sup>SD</sup> program assigned to the track. This number is automatically set whenever a program is selected from the Program Bank pages. Assigning a new program to a Preset track from Replace Program mode does *not* change the program number automatically, but sequencer tracks will acquire the new program's number.

You can set this number to any other legal program number if you wish to override the default value. This can be useful in presets and sequencer tracks, which will transmit a program change for every MIDI-enabled track when selected.

### Entering program change numbers directly

While this page is displayed (or from the Tracks 1-6 and 7-12 pages in sequencer mode), it is possible to send MIDI program change messages by holding the soft button nearest the track program name and then entering the MIDI program change number using the numbered bank buttons. When you release the soft button the program change will be sent, and the program number will be updated in the display. The range of acceptable numbers is 1 to 128. You do not have to enter leading zeroes (for example, to send 003, simply press 3 and release the soft button). The actual numbers transmitted (000 to 127) are one less than the number displayed, in compliance with the MIDI standard.

### Program Changes in the VFX<sup>SD</sup>

When programs are assigned to a track from a program bank page, their program number is automatically set according to the following scheme:

- Internal RAM programs (INT banks) are numbered from 001 to 060.
- Cartridge programs (CRT banks) are numbered from 061 to 120.
- Internal ROM programs (ROM banks) are also numbered from 001 to 060.

Refer to the System Control section description of the MIDI Control page for more information on how the VFX<sup>SD</sup> receives program changes.

## Section 4 — Effects

Understanding VFX <sup>SD</sup> Effects . . . . .	4 - 1
Program, Preset and Sequencer Effects . . . . .	4 - 2
Programming Effects . . . . .	4 - 3
The Effect Busses . . . . .	4 - 3
Effect Mixing . . . . .	4 - 4
Selecting Effects . . . . .	4 - 5
Modulators which can be applied to the effects . . . . .	4 - 5
When are new effects loaded into the ESP chip? . . . . .	4 - 6
Performance control . . . . .	4 - 7
Controllers Routed to Effects . . . . .	4 - 7
Effects Parameters . . . . .	4 - 8

### Understanding VFX<sup>SD</sup> Effects

The VFX<sup>SD</sup> has a powerful built in signal processor which can produce a variety of effects. More importantly, its functions are integrated into, rather than added onto, the rest of the synthesizer. The flexible bus routing scheme and the extensive real-time control give the VFX<sup>SD</sup> its unprecedented *dynamic* effects capability.

The VFX<sup>SD</sup> is equipped with an advanced digital signal processing system based on the ENSONIQ Signal Processor (ESP) chip. The ESP is designed specifically for digital audio signal processing and in the VFX<sup>SD</sup> it has been integrated with a third generation version of the Digital Oscillator Chip (DOC III) and an external 16-bit digital-to-analog converter to provide a very high-quality output signal.

The digital effects processing has been designed to complement the advanced performance features of the VFX<sup>SD</sup>, and many of the effects can have specific parameters modulated by various performance controls such as the mod wheel, Poly-Key pressure, and the patch select buttons.

The effects are fully programmable, and may be customized for particular applications. Effects are most often stored as part of a program, although each preset may also have its own *override* effect, independent of the effects contained by the programs included in the preset. Each individual sequence and song also has an independent effect. Each of these types of effect is treated a little differently, and will be described individually later in this section.

### Program Effects

Each program in the VFX<sup>SD</sup> contains an effect and a complete set of parameter values which determine how that effect will sound. The effect is present even if none of the voices in the program are routed through the effect (e.g. all voices are sent to the DRY destination bus - see the Output page section). Whenever you save or write a program, the effect settings are also saved with the program.

The program effect is displayed and edited by pressing the *Effect* button in the *Programming* section of the front panel. There are three pages of effect parameters, which are common to all of the effect types. These pages are described in the Effect Parameters part of this section.

If the effect that is currently loaded and being heard is different than the program effect that is being shown, then a flashing MUTE will appear in the lower left corner of the display.

### Preset Effects

Each preset in the VFX<sup>SD</sup> also contains an effect and a complete set of effect parameter values. The effect is present even if none of the tracks in the preset are routed through the effect (e.g. all tracks are sent to the DRY destination bus - see the Performance Effects page section). Whenever you save or write a preset, the effect settings are also saved with the preset.

The preset effect is often the same as the effect contained in the primary selected program in the preset, but can easily be changed to suit the needs of the preset more closely. This effect applies to all preset tracks (or their program voices) which are routed to either FX destination bus.

The preset effect is displayed and edited by pressing the *Effect* button in the *Performance* section of the front panel.

There are four pages in total. The top level page controls the routing of the effect and is described in the Performance Control part of this section. The next three pages contain the effect parameters, which are common to all of the effect types. These pages are described in the Effect Parameters part of this section.

### Sequencer Effect

Like each of the presets in the VFX<sup>SD</sup>, each sequence and song contains an effect and a complete set of effect parameter values. The effect is present even if none of the tracks in the sequence are routed through the effect (e.g. all tracks are sent to the DRY or AUX destination bus - see the Performance Effects page section). This effect applies to all sequencer tracks (or their program voices) which are routed to either FX destination bus.

The effect is saved with each sequence or song. It will remain unaffected until a new song or sequence is selected, unless it is specifically edited. A special program change message may be used to load new effects into a sequence from MIDI in Multi mode (see the MIDI Control page description of special program changes in the System Control section). The Copy function and a special mode of Copy Preset to Sequence can be used to replace the Sequence effect.

The sequencer effect is displayed and edited by pressing the *Effect* button in the *Performance* section of the front panel, when the VFX<sup>SD</sup> is in sequencer mode.



## Programming Effects

The VFX<sup>SD</sup> effects are fully programmable. There are three sub-pages of effect parameters for every effect type. The first sub-page contains the effect selector. The effect selector is a little different than all of the other parameters in that it controls how all of the other effect pages will be configured and displayed. When this parameter is changed, a new effect preset is selected which causes several important things to occur.

When a new effect preset is selected:

- a new effect preset is loaded, causing a brief pause in the audio output
- the effect parameter pages are redefined for the particular effect selected
- the effect parameter values are reset to their default settings for the preset effect

Hint: When editing the effect selector, it is possible to change the new effect type quickly and avoid the brief delay caused by the actions described above. Pass rapidly over the types between the old type and the new type, and then pause. The new effect preset will be recalled only after you stop changing the type.

### The Effects Busses

The output of every voice in the VFX<sup>SD</sup> is assigned to a stereo bus. A bus, like the bus of a mixing board, mixes together all the voices assigned to that bus into a single stereo pair. Of the four busses on the VFX<sup>SD</sup>, two are inputs into the signal processor (FX1 and FX2), another is a direct path to the Main outputs which bypasses all effect processing (DRY), and the fourth is a direct path to the Aux outputs which also bypasses all effect processing (AUX). The Destination Bus assignment for each voice is set on the Output page. The voice settings in the program can be over-ridden for each preset and sequencer track on the top-level of the Performance Effects page.

### Single function effect

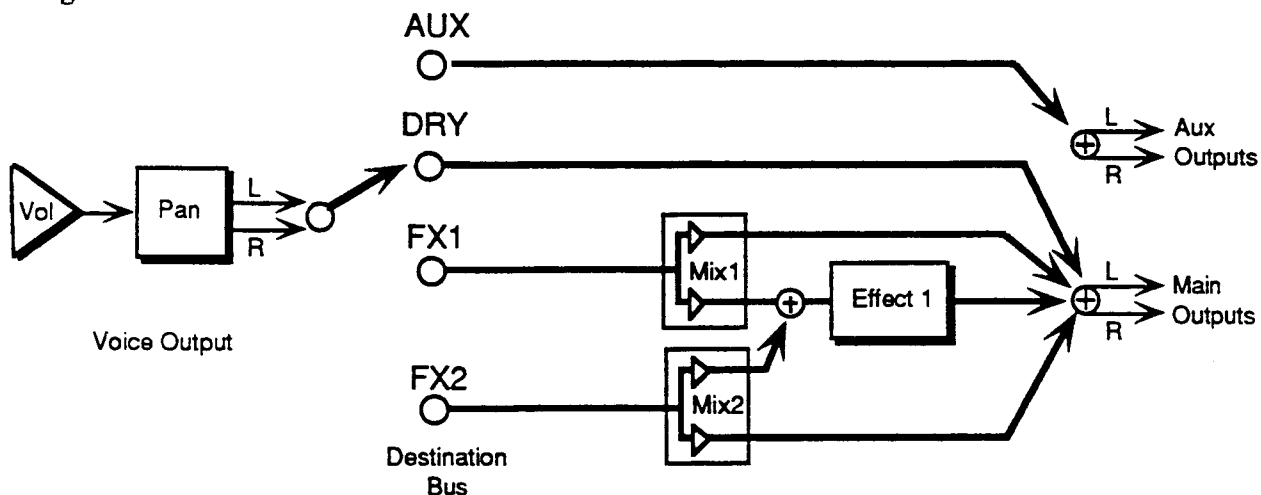

The above illustration shows the effects busses and the output mixing. Every voice is assigned to one of the four stereo busses, which go around or through the effects processing. The heavy lines are stereo paths.

## Effects Mixing

All effects have separate mixing controls for the FX1 and FX2 busses.

When an effect with a single processing function (such as reverb only) is selected, both busses FX1 and FX2 are routed to it. Mix1 controls the amount sent to the effect or sent around it. In this case bus FX2 can be used in two modes.

- **NORMAL.STEREO.SEND**—in this case FX2 functions exactly like FX1, but provides a separate effects mix amount. This can be useful for setting up one bus with more effect processing than the other. Voices can then be routed to the most appropriate bus, depending on how much effect is desired.
- **LEFT.WET/RIGHT.DRY**—in this configuration a voice's pan position determines its (individual) effects mix. Pan can be modulated in real-time with modulators such as Poly-Key pressure, and when pan is treated as wet/dry mix, it allows real-time modulation of effect mix. This is one of the unique *dynamic* effects which the VFX<sup>SD</sup> offers. In this mode, pan affects only the wet/dry mix and does not affect stereo image panning from left to right.

## Multiple function effect

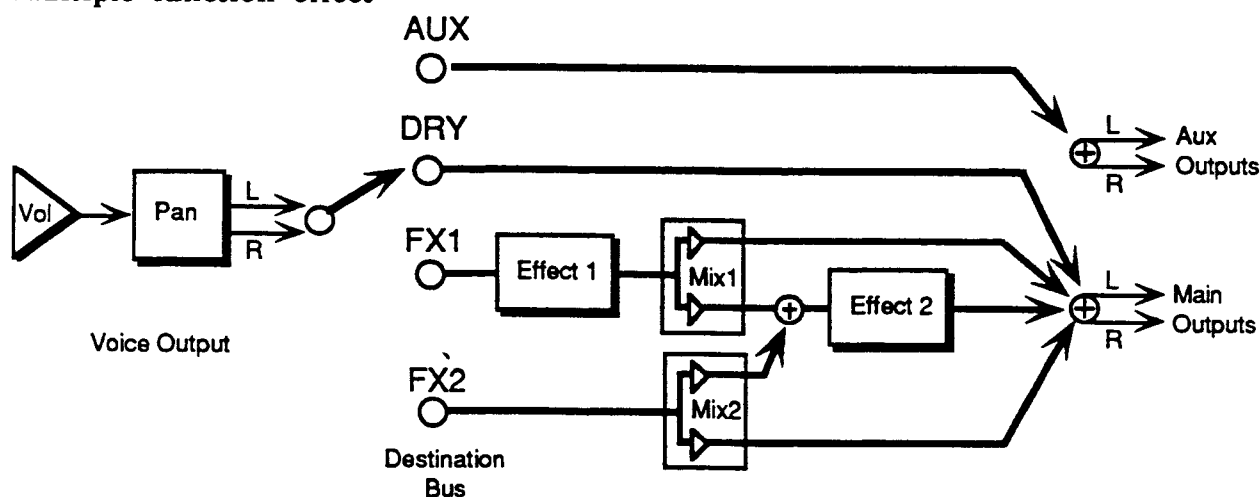

When the selected effect is a *combined effect* that has more than one signal processing function (such as chorus and reverb), the FX1 bus feeds Effect 1, and the FX2 bus feeds Effect 2. The FX2 Mix control sets the amount of Effect 2 (usually reverb) for voices assigned to that bus. FX1 Mix controls the amount of the output from Effect 1 sent to Effect 2 rather than directly to the output. By setting this control to its extremes, you can arrange the two effects to be either in series or in parallel.

One exception to this rule is the GATED+ROOM VERBS effect which contains two entirely separate reverb algorithms. In the case of this effect, the two different effects busses are always in parallel:

- Voices sent to the FX1 bus will go to the gated reverb; the FX1 Mix determines the wet/dry mix of those voices.
- Voices sent to the FX2 bus will go to the regular room reverb; the FX2 Mix determines the wet/dry mix of those voices.

Also, in the triple effect, FLANGE+DLY+REV, the flanger and delay together are treated as Effect 1, with the reverb treated as Effect 2.

## Selecting Effects

The first parameter of the Effects page is the effects selector. Changing this parameter causes a new effect to be selected, which in turn changes the type of parameters which will be available on the rest of the pages. Selecting a new effect preset will automatically set all of the effect parameters to their default values for the new effect. The available Effects are:

LARGE.HALL.REV	large hall, high density reverb
SMALL.HALL.REV	small hall, high density reverb
CONCERT REVERB	concert hall reverb
ROOM.REVERB.1	medium room reverb with more early reflections
ROOM.REVERB.2	small room reverb with more early reflections
WARM CHAMBER	chamber reverb with lots of early reflections
DYNAMIC.REVERB	Large Hall reverb with modulatable decay time
DYNAMIC.HALL	Concert reverb with modulatable decay time
GATED+ROOM VERBS	separate gated reverb and room reverb
8-VOICE.CHORUS.1	eight voice chorus with complex modulation
8-VOICE.CHORUS.2	alternate chorus algorithm with complex modulation
CHORUS+REVERB.1	chorus combined with reverb
CHORUS+REVERB.2	(variation)
FLANGER+REVERB.1	flanger combined with reverb
FLANGER+REVERB.2	(variation)
DELAY+REVERB.1	delay line combined with reverb
DELAY+REVERB.2	(variation)
FLANGE+DLY+REV.1	flanger with delay combined with reverb
FLANGE+DLY+REV.2	(variation)
DLY+FLANGE+REV.3	(variation)
ROTO-SPKR+DELAY	rotating speaker simulator with delay
DIRTY-ROTO+DELAY	rotating speaker simulator with overdrive plus delay

## Modulators which can be applied to the effects

The following modulation sources are available to alter the effects in performance:

<u>Mod Source</u>	<u>Modulation effect derived from</u>
KEY-GATE	on when any keys are pressed; off otherwise
KEYBOARD	the number of the last key played
VELOCITY	the average velocity of all keys played
PRESSURE	the channel pressure value for track
PITCHWHL	the value of the pitch wheel
MODWHEEL	the value of the mod wheel
MODPEDAL	the value of the CV/Pedal input
XCONTROL	uses the value of the assignable external MIDI controller, such as the breath controller
SUS-PEDAL	on when held down; otherwise off
TIMBRE	the value of the TIMBRE parameter for the track, if the track is set to CONTROL (see below)
PATCHSEL	four values (0,32,64,127) for the four button states
*OFF*	no modulation

## Programs and Presets

The complete effects setup, including the values of all effect parameters, is saved when you save a program. It is *also* saved with the performance presets. The VFX<sup>SD</sup> tries to be smart about switching effects, since all sound must stop for an instant when it changes effects.

### When are new effects loaded into the ESP chip?

- When you select a program from one of the Program Bank pages, the effect saved in that program will be loaded into the ESP, and you will hear the program with its effect. If you layer a program by double-clicking, its effect will *not* be loaded.
- When you select or layer programs/tracks from a preset or performance parameter page, the effect is *not* changed.
- When you change the program on a track from Replace Program mode (e.g. with the *Sounds* LED blinking), the effect will *not* be changed.
- When you select a preset, the override effect saved in that preset will be loaded into the ESP.
- When you select song or sequence, the effect saved in that song or sequence will be loaded into the ESP.

Whenever a new effect is loaded into the ESP, the audio output will pause briefly, allowing the instructions which create the new effect to be loaded into the ESP. If an effect differs only by variation in parameter values, then this pause may not occur.

These are the rules that the VFX<sup>SD</sup> follows in deciding when to change effect programs:

1. When you select a new primary sound it changes to that sound's effect.
2. When you layer a sound by double clicking, the effect is not changed.
3. When you select a performance preset, it changes to that preset's effect.
4. When you select a new song or sequence, it changes to that song or sequence's effect.
5. Whenever you go from Sounds mode to Sequence mode (by pressing *Seq*) the sequence effect is loaded. The same is true when going from Sequence mode to Sounds mode (by pressing *Sounds*).
6. When you bring a sound into an existing preset or sequencer track using *Replace Program* it will not change the effect.
7. Saving either the the sound or the preset will save the *current* effect.
8. Should you start editing a sound while an effect *other than its own* is active, a warning will appear, reminding you that you are not hearing the effect whose parameters you are seeing or editing. This warning appears as MUTE flashing in the lower left corner of the display.
9. When a special MIDI program change message (#125) is received in MULTI mode, the next program change received will cause the sequence effect to be loaded with the one in the program.

### Performance Control of Effects in Preset or Sequencer mode

When the VFX<sup>SD</sup> is in Preset mode or Sequencer mode, the effect for the current preset, song or sequence is edited by pressing the *Effect* button in the Performance section of the front panel.

The *Effect* button in the Performance section has one more level than the Programming Effect button. The first time it is pressed it shows the *FX Bus Override* parameter for each of the three tracks in a performance preset (or for 6 of the 12 tracks of the current song or sequence in Sequencer mode). Subsequent presses reveal the effects programming parameters, which are identical to those found in the Programming section.

Normally, different voices in a program are assigned to the four different busses, as set on the Output page. The *FX Bus Override* parameter provides for the re-routing of the voices without editing the sound itself. This may be useful when two sounds are split or layered in a performance preset, and the effect is not appropriate for both. Also, this is used to assign a track to the Aux Outputs for separate processing or mixing.

The available settings are:

- -DRY- forces all voices to the dry bus
- -FX1- forces FX2 voices to FX1; FX1 and DRY are unaffected
- -FX2- forces FX1 voices to FX2; FX2 and DRY are unaffected
- VOICE uses normal voice routing
- CNTRL uses normal voice routing and also routes controller information to the effect. This is the default setting in the track after selecting a primary program.
- -AUX- forces all voices to the Aux outputs, bypassing the effects

### Controllers Routed to Effects

In effects which allow real-time control, it is sometimes desirable to limit *which tracks* send controller information to the effect. This is particularly true when using multiple MIDI input channels from a sequencer. If more than one track is set to CNTRL, "controller fights" can occur. If set to VOICE, a track will remain routed to the effects, but its controllers (such as the TIMBRE control, MODWHEEL, etc.) will not affect the effect.

## Effect Parameters

Each of the effect types has three sub-pages containing a particular set of parameters associated with the effect. Some of the parameters are common to many effects and some are specific to certain effects. The first page of parameters is very similar for all of the effects. The second and third sub-pages are more variable, and contain the specific parameters.

In some cases, several presets of the same type will have an identical set of parameters. In these cases, the parameters will only be described once, but the effect presets which share those parameters will be listed at the beginning of the description.

Each effect has an FX1 Mix and an FX2 Mix, plus a set of parameters which is relevant to the effect. All of these parameters are programmable, and provide much flexibility for customizing the effects.

## Single Effects

The effects algorithms in this category provide a single highly optimized stereo effect, such as studio quality reverb or complex chorusing. The FX1 and FX2 busses may both be routed into the effect with different mixes

### **LARGE.HALL.REVB**

large acoustic space, high density reverb

### **SMALL.HALL.REVB**

small concert hall, high density reverb

### **CONCERT REVERB**

concert hall reverb

### **ROOM.REVERB.1 & 2**

smaller room reverbs with more early reflections

### **WARM CHAMBER**

chamber reverb

### **DYNAMIC.REVERB**

based on the Large Hall Reverb algorithm, this provides a number of interesting effects by allowing decay time to be modulated

### **DYNAMIC.HALL**

based on Concert Reverb algorithm, this also allows decay time to be modulated

The parameters available in these seven effects algorithms are:

DECAY TIME	
PRE-DELAY	
EARLY-REFL.LEVEL	
FX2-MODE	
HF-DAMPING	
MODSRC . . . . .	Dynamic Reverb & Dynamic Hall only
DECAY-MOD . . . . .	Dynamic Reverb & Dynamic Hall only
EARLY-REFL. TIME . . . . .	Concert Reverb & Warm Chamber only
DIFFUSION . . . . .	Concert Reverb & Warm Chamber only
LF-DECAY . . . . .	Concert Reverb & Warm Chamber only

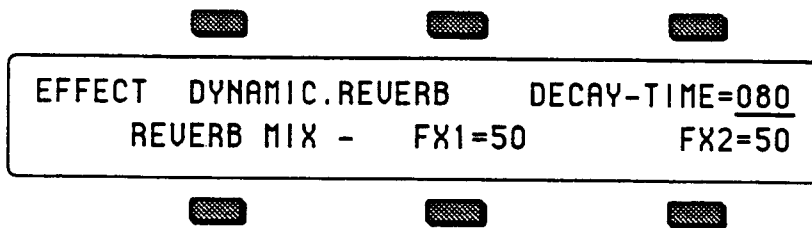
**DECAY-TIME**

Range: 0 to 100

Controls the amount of time it takes for the reverberation to decay away to a very low level (-60 dB) after the input signal stops.

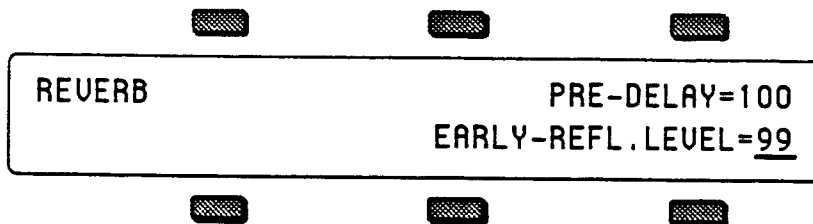
**PRE-DELAY**

Range: 0 to 250 milliseconds

As its name implies, this parameter controls the length a short delay which occurs before the reverb. Pre-delay is the amount of time it takes for the reverberation to begin after the input signal is present.

**EARLY-REFL.LEVEL**

Range: 0 to 99

This parameter controls the amount of early reflections mixed into the reverberation. Early reflections are the very short delays which occur at the very beginning of the reverb, and are caused by sound waves being reflected back from the walls of the hall or room.

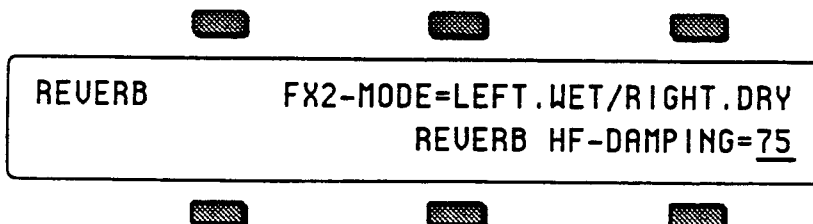
**FX2-MODE**

- **NORMAL.STEREO.SEND**—in this mode, each voice's pan acts normally and balances left to right ratio of the stereo input to the effect
- **LEFT.WET/RIGHT.DRY**—in this mode, pan is used to control the wet-to-dry mix ratio instead of the stereo balance. Panning to the left will increase the amount of signal sent to the effect, and panning to the right will decrease the effect level and increase the dry or bypass level. The left channel of FX2 is sent directly to the effect without mixing. The right channel of FX2 is routed around the effect and appears in the center of the main stereo output. Since panning can be dynamically controlled on each individual voice, this mode allows each voice to have a separate dynamic effect mix.

**HF-DAMPING**

Range: 0 to 99

The High Frequency Damping parameter controls the amount of attenuation of high frequencies in the decay of the reverberation. As natural reverb decays, some high frequencies tend to get absorbed by the environment. Increasing the value of this parameter will filter out increasing amounts of high frequency energy.

For the DYNAMIC.REVERB and DYNAMIC.HALL effects, there are two additional parameters on the second sub-page which control the modulation of decay time.

**DECAY-MOD**

Range: -99 to +99

This parameter controls the amount of modulation from the selected modulation source which will be applied to the decay time of the reverb.

**MODSRC**

This parameter selects the modulation source to be used. Any one of the effect modulators can be selected.

For the CONCERT REVERB and WARM CHAMBER effects, there are three additional parameters on the second and third sub-pages which control allow greater control over the early reflections and the low-frequency content.

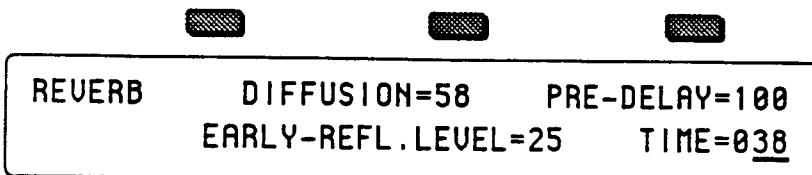
**DIFFUSION**

Range: 00 to 99

This parameter determines whether the early reflections will appear as a series of discrete echoes (lower values) or will be more diffused (higher values)

**TIME — Early Reflection Time**

Range: 00 to 200 milliseconds

Controls the time it takes for the early reflections to reach the listener.

**LF-DECAY — Low Frequency Decay**

Range: -99 to +99

This parameter, on the third sub-page of the CONCERT REVERB and WARM CHAMBER effects, controls the amount of low frequency content in the decay.



**8-VOICE.CHORUS.1 and 8-VOICE.CHORUS.2**

This is a complex chorus with eight different voices and separately randomized LFO's.

RATE  
DEPTH  
DELAY  
FEEDBACK  
FX2-MODE

  
 EFFECT 8-VOICE.CHORUS.1  
 EFFECT MIX - FX1=50 FX2=50

These two algorithms do not incorporate any reverb, and the first sub-page does not include the DECA Y-TIME parameter.

  
 CHORUS RATE=25 DEPTH=99 DELAY=100  
 FEEDBACK=+99

**RATE**

Range: 00 to 99  
This parameter controls the rate of modulation of the delay time of the chorus.

**DEPTH**

Range: 00 to 99  
This parameter controls the amount of modulation applied to the delay time of the chorus.

**DELAY**

Range: 00 to 250 milliseconds  
This parameter controls the delay time of the chorus.

**FEEDBACK**

Range: -99 to +99  
This parameter controls the amount of positive or negative feedback applied to the chorus.

  
 CHORUS FX2-MODE=LEFT.WET/RIGHT.DRY

**FX2-MODE**

- **NORMAL.STEREO.SEND**—in this mode, pan acts normally and balances left to right ratio of the stereo input to the effect
- **LEFT.WET/RIGHT.DRY**—in this mode, pan is used to control the wet-to-dry mix ratio instead of the stereo balance. Panning to the left will increase the amount of signal sent to the effect, and panning to the right will decrease the effect level and increase the dry or bypass level. Refer to the preceding description of FX2 MODE for more information.

**Combined Effects**

The other effects in the system generally include a standard reverb on the FX2 bus combined with a different effect on the FX1 bus. You can control the amount of FX1 that is sent into the reverb (FX2) with the FX1 mix control. **DECAY-TIME** for the reverb appears on the first sub-page for all of these combined effects.

**GATED+ROOM.VERBS**

This effect combines a contemporary gated reverb on the FX1 bus with a standard room reverb on FX2. This algorithm gives you two different reverbs at once and is thus good for use when sequencing. Drums can be assigned to the gated reverb and other voices to the room reverb. Assign a voice to FX1 to get gated reverb only, or use FX2 for room reverb only.

TIME . . . . .	Gated Reverb parameter
SLOPE . . . . .	Gated Reverb parameter
THRESHOLD . . . . .	Gated Reverb parameter
PRE-DELAY . . . . .	Gated Reverb parameter
RELEASE-TIME . . . . .	Gated Reverb parameter
DECAY TIME . . . . .	Room Reverb parameter
PRE-DELAY . . . . .	Room Reverb parameter
REVERB HF-DAMPING . . . . .	Room Reverb parameter



EFFECT GATED+ROOM.VERBS    DECAY-TIME=65  
 REVERB MIX -    FX1=50                      FX2=50



The first sub-page is basically the same as the other combined effects. The FX1 Mix level controls the wet/dry mix of the gated reverb, and the FX2 Mix level controls the wet/dry mix of the room reverb. The Decay Time parameter controls the decay time of the room reverb (see the previous **DECAY-TIME** description).

The second sub-page contains parameters which control the gated reverb. The gated reverb algorithm simulates the sound of a reverb passed through a noise gate. You can control the time the gate stays open, the threshold level at which it will open and close down, and the time it takes the reverb to settle out after the input level falls below the threshold.

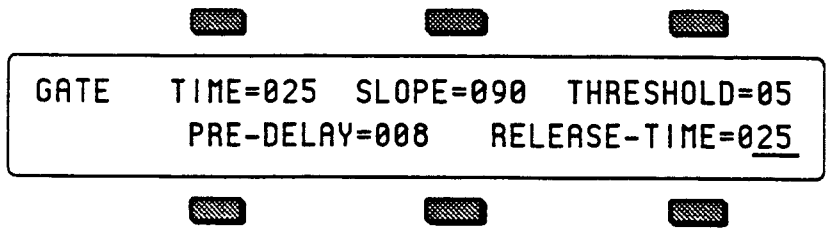

**TIME**

Range: 00 to 200  
 This parameter controls the amount of time the noise gate stays open after the input level (the dry signal) crosses the threshold.

**SLOPE**

Range: 00 to 100  
 This parameter controls the linearity of the reverb within the algorithm. At low values the reverb will decay away quickly; at high values the reverb level will decay away much more slowly, creating a nonlinear effect.

**THRESHOLD**

Range: 00 to 99  
 This controls the input level at which the noise gate will open and close.

**PRE-DELAY**

Range: 00 to 200  
 This parameter controls the length a short delay which occurs before the gated reverb. Pre-delay is the amount of time it takes for the reverberation to begin after the input threshold is crossed.

**RELEASE-TIME**

Range: 00 to 200  
 The Release Time parameter controls the rate at which the reverb level will fall to zero after the input signal falls below the threshold.

The remaining two parameters on the third sub-page control the PRE-DELAY and HF DAMPING for the room reverb:

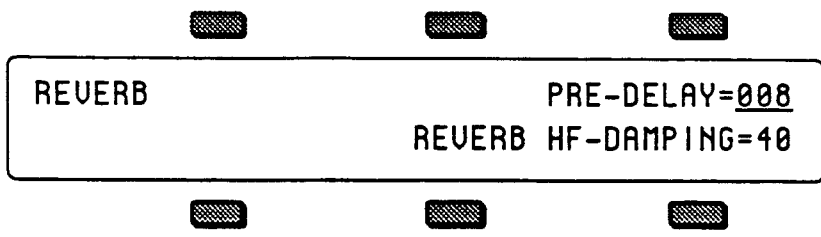

Refer to the description of HF DAMPING and PRE-DELAY earlier in this section for details.

**CHORUS+REVERB.1 & 2**

This effect combines a simple chorus with the standard reverb. The chorus has an LFO which modulates a variable length delay line. Assign a voice to FX1 to get both chorus and reverb, or use FX2 for reverb only.

MIX  
 RATE  
 RATE MODAMT  
 WAVESHAPE  
 DEPTH  
 DEPTH MODAMT  
 MODSRC  
 DELAY  
 DECAY TIME . . . . . Reverb parameter  
 REVERB HF-CUT . . . . . Reverb parameter

EFFECT	<u>CHORUS+REVERB</u>	DECAY-TIME=65
REVERB MIX -	FX1=50	FX2=50

The first sub-page is basically the same as the other combined effects. The FX1 Mix level controls how much of the chorus output signal is sent to the reverb, and the FX2 Mix level controls the amount of the FX2 bus signal sent to the reverb only. The Decay Time parameter controls the decay time of the reverb (see the previous DECAY-TIME description).

CHORUS	RATE=25	DEPTH=99	DELAY=030
	MOD=+99	MOD=-99	MIX= <u>85</u>

**RATE**

Range: 00 to 99  
 This parameter controls the rate of modulation of the delay time of the chorus.

**DEPTH**

Range: 00 to 99  
 This parameter controls the amount of modulation applied to the delay time of the chorus.

**DELAY**

Range: 00 to 250 milliseconds  
 This parameter controls the delay time of the chorus.

**Rate MOD**

Range: -99 to +99  
 This parameter controls the amount of modulation applied to the chorus rate.

**Depth MOD**

Range: -99 to +99

This parameter controls the amount of modulation applied to the chorus depth parameter.

**MIX**

Range: 00 to 99

This parameter controls the mix level or amount of the chorus effect.

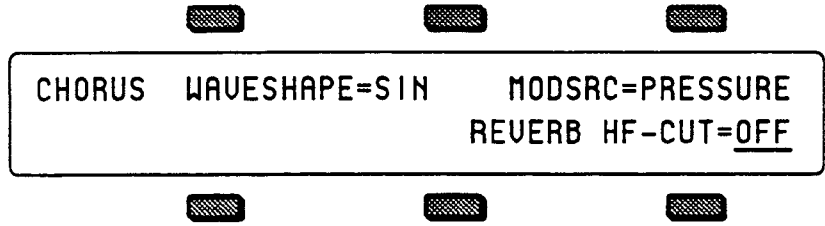

**WAVESHAVE**

This parameter determines the shape of the waveform used to modulate the chorus parameters.

- SIN—the modulation waveform is a sine wave.
- TRI—the modulation waveform is a triangle wave.

**REVERB.HF-CUT**

This switch is similar to the High Frequency Damping parameter in that it controls the amount of attenuation of high frequencies in the reverberation. The difference is that here the amount of high frequency attenuation is fixed.

- ON—higher frequencies are attenuated (rolled-off) in the reverberation signal.
- OFF—higher frequencies are unaffected.

**FLANGER+REVERB.1 & 2**

The flanger algorithm is similar to the chorus but with different controls. The LFO changes the length of the delay line within the limits of MIN and MAX, and the flanger mix is variable. Assign a voice to FX1 to get both flanger and reverb, or use FX2 for reverb only.

- RATE
- MIN
- Min MOD amount
- MAX
- Max MOD amount
- MODSRC
- MIX-LEVEL
- FEEDBACK
- DECAY TIME . . . . . Reverb parameter
- REVERB HF-CUT . . . . . Reverb parameter

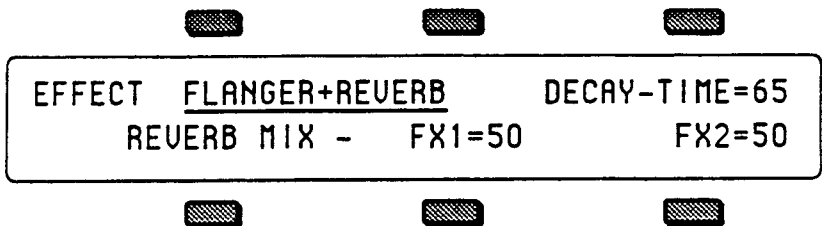

The first sub-page is basically the same as the other combined effects. The FX1 mix level controls how much of the flanger output signal is sent to the reverb, and the FX2 mix level controls the amount of the FX2 bus signal sent to the reverb only. The Decay Time parameter controls the decay time of the reverb (see the previous DECAY-TIME description).

FLANGER	RATE=40	MIN=040	MAX=080
	MODSRC=MODWHEEL	MOD=-99	MOD=+99

**RATE**

Range: 00 to 99

This parameter controls the rate at which the notch frequency of the flanger is modulated from MIN to MAX. If set to 00, then the notch will be fixed at some point in the sweep range, though this point is unpredictable.

**MIN**

Range: 0 to 127

This parameter sets the minimum notch frequency of the flanger. The units are semitones, so if you wish to decrease the notch frequency by an octave, subtract 12.

**MAX**

Range: 0 to 127

This parameter sets the maximum notch frequency of the flanger. The units are semitones, so if you wish to increase the notch frequency by an octave, add 12.

**Min MOD**

Range: -99 to +99

This parameter controls the amount of external modulation applied to the MIN parameter.

**Max MOD**

Range: -99 to +99

This parameter controls the amount of external modulation applied to the MAX parameter.

**MODSRC**

This parameter selects the external modulation source to be used to modulate the flanger MIN and MAX parameters. Any one of the effect modulators can be selected.

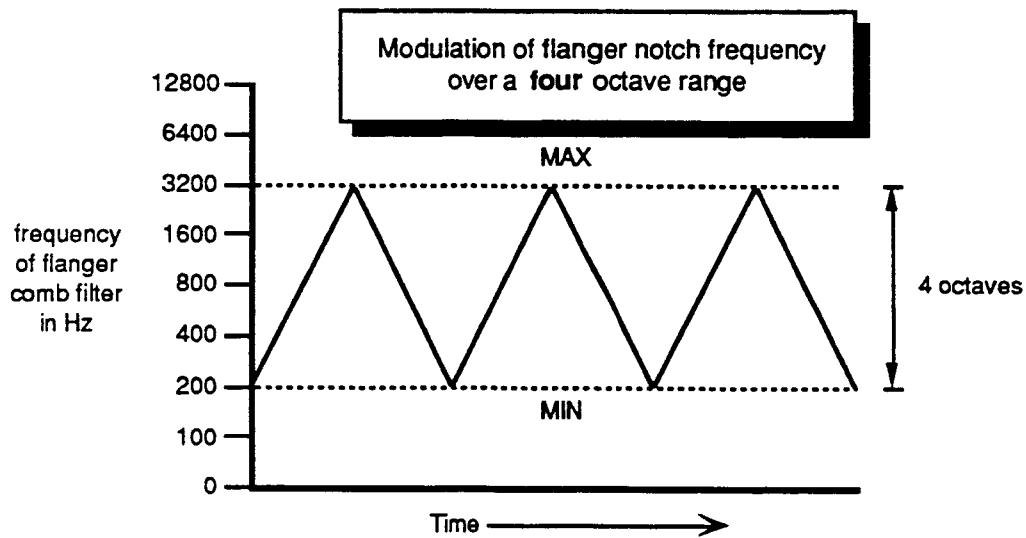

These illustrations show how the relationship between the MIN and MAX settings will determine the frequency range and *apparent* rate of the flanger sweep. The actual rate at which the sweep changes from MIN to MAX is constant, so if the range is narrow, the apparent or perceived rate will be faster.

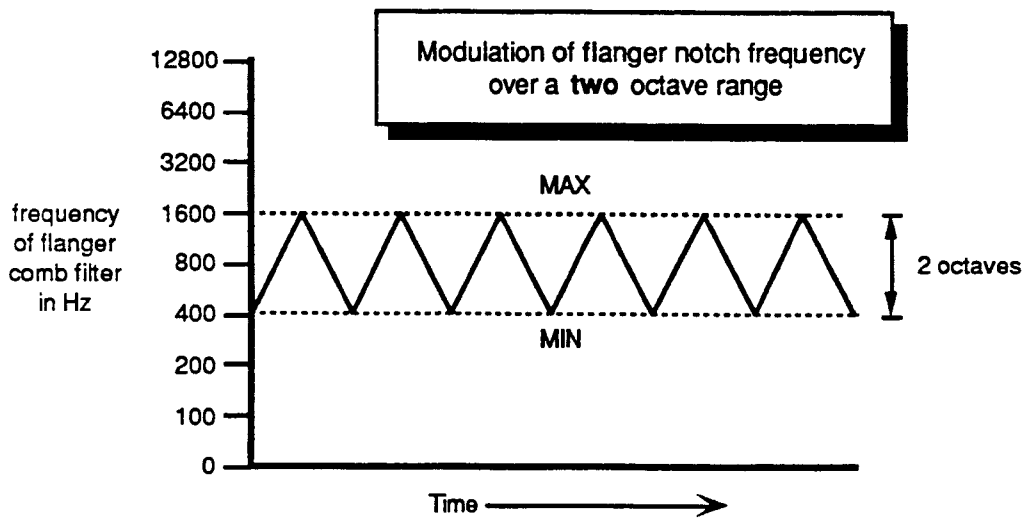

If the settings are modulated, then both the fixed frequency of the notch and/or range of frequencies in the sweep can be affected. Modulated sweeps can be implemented by setting MIN and MAX to the same value (or close together) and modulating them by the same amount. Manual sweeps can be implemented by selecting a modulation source such as the mod wheel.

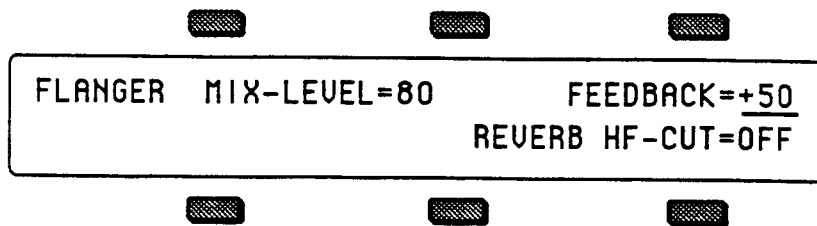

**MIX-LEVEL**

Range: 0 to 99 (16 values)  
 This parameter controls the mix level or amount of the flanger effect.

**FEEDBACK**

Range: -99 to +99  
 This parameter controls the amount of feedback applied to the flanger. The sign of the value determines the polarity of the feedback.

**REVERB.HF-CUT**

This switch is similar to the High Frequency Damping parameter in that it controls the amount of attenuation of high frequencies in the reverberation. The difference is that here the amount of high frequency attenuation is fixed.

- ON—higher frequencies are attenuated (rolled-off) in the reverberation signal.
- OFF—higher frequencies are unaffected.

**DELAY+REVERB.1 & 2**

A digital delay with 500 msec maximum delay, and a standard reverb. Assign a voice to FX1 to get both delay and reverb, or use FX2 for reverb only.

- DELAY TIME
- DELAY MODAMT
- MIX
- REGEN
- REGEN MODAMT
- MODSRC
- DECAY TIME . . . . . Reverb parameter
- HF-DAMPING . . . . . Reverb parameter

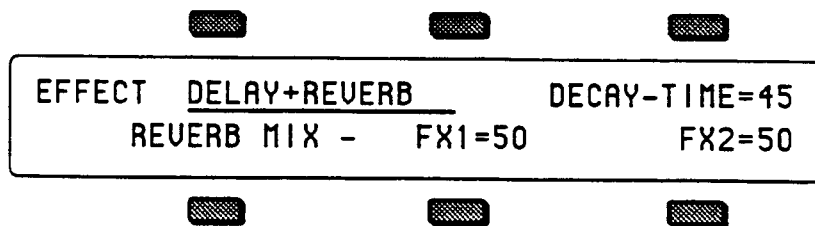

The first sub-page is basically the same as the other combined effects. The FX1 mix level controls how much of the delay output signal is sent to the reverb, and the FX2 mix level controls the amount of the FX2 bus signal sent to the reverb only. The Decay Time parameter controls the decay time of the reverb (see the previous DECAY-TIME description).

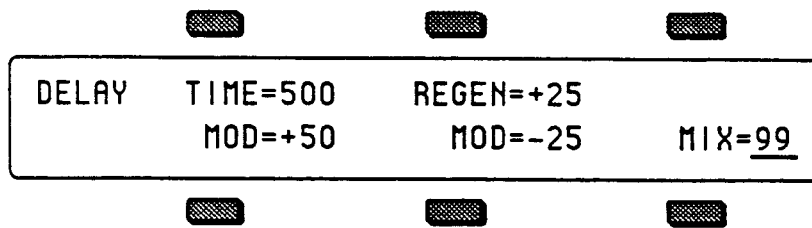

**TIME**

Range: 0 to 500 milliseconds (by 2)  
 This parameter controls the delay time of the FX1 bus delay line.

**Time MOD**

Range: -99 to +99  
 This parameter controls the amount of modulation applied to the TIME parameter.

**REGEN**

Range: -99 to +99  
 This parameter sets the amount of regeneration applied to the delay. Regeneration is analogous to feedback, and with more regeneration, there will be more delayed repeats.

**Regen MOD**

Range: -99 to +99  
 This parameter controls the amount of modulation applied to the REGEN parameter.

**MIX**

Range: 0 to 99  
 This parameter sets the level of the delayed signal.

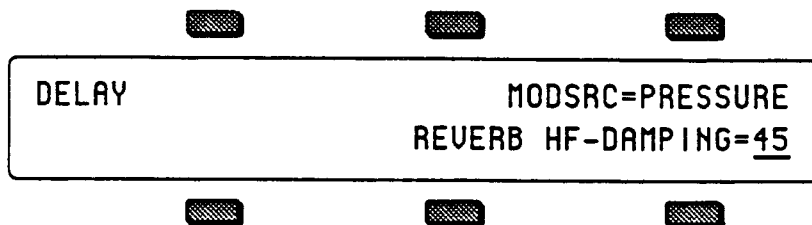
**MODSRC**

This parameter selects the modulation source to be used to modulate the delay TIME and REGEN parameters. Any one of the effect modulators can be selected.

**HF-DAMPING**

Range: 0 to 99  
 The High Frequency Damping parameter controls the amount of attenuation of high frequencies in the reverberation. Refer to the description of HF DAMPING in the reverb section above for more information.

**FLANGE+DLY+REV.1 & 2  
DLY +FLANGE +REV.3**

These Effects combines the flanger with a delay and the standard reverb. The difference is that the first two place the delay *after* the flanger, while the third places the delay before the flanger. The functions of the parameters are closely related to those in the individual effects. Assign a voice to FX1 to get both flanger and delay with reverb, or use FX2 for reverb only.

RATE . . . . .	Flanger parameter
MIN . . . . .	Flanger parameter
MAX . . . . .	Flanger parameter
FEEDBACK . . . . .	Flanger parameter
MIX . . . . .	Delay parameter
TIME . . . . .	Delay parameter
REGEN . . . . .	Delay parameter
DECAY TIME . . . . .	Reverb parameter
REVERB HF-CUT . . . . .	Reverb parameter



EFFECT FLANGE+DLY+REV      DECAY-TIME=30  
 REVERB MIX -      FX1=50      FX2=50



The first sub-page is basically the same as the other combined effects. The FX1 mix level controls how much of the flanger and delay output signal is sent to the reverb, and the FX2 mix level controls the amount of the FX2 bus signal sent to the reverb only. The Decay Time parameter controls the decay time of the reverb (see the previous DECAY-TIME description).



FLANGER RATE=25      MIN=015      MAX=045  
 FEEDBACK=-30



Refer to the FLANGER+REVERB description for these parameters.



DELAY      TIME=400      REGEN=+40      MIX=99  
    REVERB HF-CUT=OFF



Refer to the DELAY+REVERB description for these parameters.

**ROTO.SPKR+DELAY**

A rotating speaker simulator with delay

**DIRTY-ROTO+DELAY**

A rotating speaker simulator with overdrive along with a delay

DELAY  
 SLOW Speed  
 FAST Speed  
 MODSRC  
 LO-ROTOR On/Off . . . . . ROTO.SPKR+DELAY only  
 STEREO-WIDTH . . . . . ROTO.SPKR+DELAY only  
 MODE  
 Feedback LAG  
 Feedback AMOUNT  
 OVERDRIVE . . . . . DIRTY-ROTO+DELAY only  
 LOW ROTOR VOL . . . . . DIRTY-ROTO+DELAY only  
 REPEATS . . . . . Delay only parameter

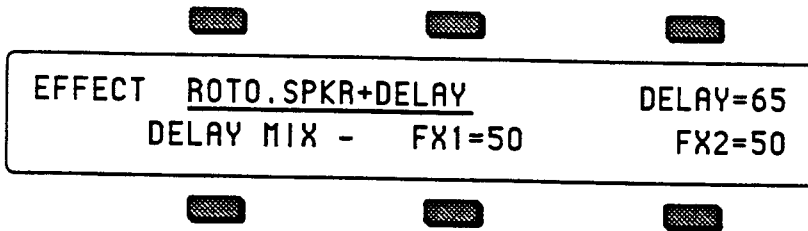

The first sub-page is very similar to the other combined effects. The top right parameter is the Delay time. When Delay is active, the FX1 mix level controls how much of the rotating speaker signal is sent to the delay, and the FX2 mix level controls the amount of the FX2 bus signal sent to the delay only.

**DELAY**

Range: 0 to 400 milliseconds (by 2)  
 This parameter determines the length or delay time of the FX2 delay.

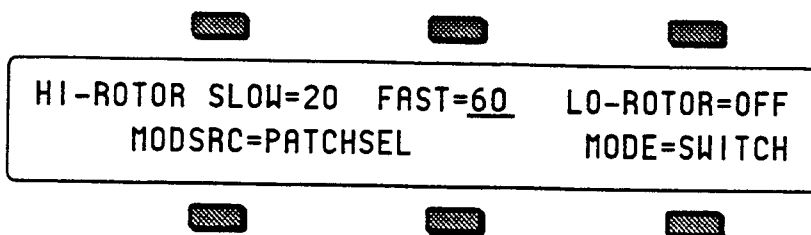

**HI-Rotor SLOW Speed and FAST Speed**

Range: 0 to 99  
 These parameters set the minimum and maximum speeds of the upper rotor of the rotating speaker.

**LO-ROTOR switch — (ROTO.SPKR+DELAY only)**

Range: On or Off  
 This switch turns the lower rotor on and off, affecting the low frequency sound.

**OVERDRIVE — (DIRTY-ROTO+DELAY only)**

Range: 0 to 99

This parameter determines how much overdrive is applied to the speaker sound to simulate the characteristic distortion often associated with this effect.

**MODSRC**

This parameter selects the modulation source to be used to control the speed of the rotating speaker. Any one of the effect modulators can be selected. Note that the MODE parameter also affects speed control.

**MODE**

This parameter determines how the speed of the rotating speaker is controlled.

- CONTIN — continuously variable speed control tracking the values of the modulation source (for example, the CV-PEDAL input can be used to vary the speed).
- SWITCH — the rate is switched between two fixed speeds using the two states of the controller, and the speed change is gradual.
- TOGGLE — the rate toggles or alternates between two speeds whenever the controller is used.

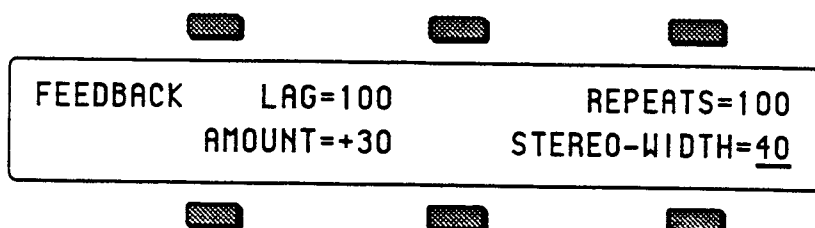
**Feedback - LAG**

Range: 0 to 100 milliseconds

This parameter determines how much time elapses before the simulated speaker resonance or feedback begins to occur.

**Feedback - AMOUNT**

Range: -99 to +99

The Feedback Amount parameter controls the amount and polarity of the resonance or feedback to the speaker simulator.

**REPEATS**

Range: -99 to +99

This parameter acts like Delay Regeneration, and controls the number of repeats of the FX2 delay.

**STEREO-WIDTH — (ROTO.SPKR+DELAY only)**

Range: 0 to 99

This parameter controls the apparent width of the stereo image created by the rotating speaker effect.

**LO-ROTOR VOL — (DIRTY-ROTO+DELAY only)**

Range: 0 to 99

This parameter controls the volume of the low rotor. The low rotor volume is also affected by the overdrive parameter, so if you set the overdrive to a very high level you should turn this parameter down a bit to compensate.

## Section 5 — Sequencer Basics

- This section contains an introduction to the VFX<sup>SD</sup> sequencer and all the information you'll need to get started sequencing. More advanced functions are covered in Section 12 - Sequencer Editing Functions and Section 13 - Sequencer Applications.

Introduction . . . . .	5 - 2
The MIDI Connection . . . . .	5 - 2
Digital Sequencing . . . . .	5 - 2
Loading the Sequencer Operating System from Disk . . . . .	5 - 3
What is a Sequence? . . . . .	5 - 4
What is a Song? . . . . .	5 - 4
Sequencer "Transport Controls" . . . . .	5 - 4
Sequencer Status . . . . .	5 - 5
Sequencer Banks . . . . .	5 - 6
Selecting a Sequence or Song . . . . .	5 - 6
Playing Sequences and Songs . . . . .	5 - 6
Sequencer Tracks . . . . .	5 - 7
Replacing the Program on a Track . . . . .	5 - 8
Layering Programs on The Tracks Pages . . . . .	5 - 8
Sequencer Tracks and the Performance Parameters . . . . .	5 - 8
Copying a Preset into 3 Sequencer Tracks . . . . .	5 - 10
Creating a New Sequence or Song . . . . .	5 - 11
Erasing All Sequencer Memory . . . . .	5 - 12
Sequencer Pages:	
Click Page . . . . .	5 - 13
Seq Control Page . . . . .	5 - 14
Locate Page . . . . .	5 - 18
Edit Times — Using the Autopunch Feature . . . . .	5 - 21
Edit Times in Song Mode . . . . .	5 - 22
Setting the Edit Times in Real Time . . . . .	5 - 22
Recording a Sequence . . . . .	5 - 23
"Punching In" on a Track . . . . .	5 - 25
Playing along with a Sequence/Auditioning New Sounds . . . . .	5 - 26
MIDI Sequencing:	
MIDI Sequencing on the VFX — MIDI Connections . . . . .	5 - 26
MIDI Mode and Channel — Destination Instruments . . . . .	5 - 27
MIDI Track Configuration . . . . .	5 - 27
Recording MIDI Tracks . . . . .	5 - 28
Additional Sequencer Functions:	
Recording Controllers into Sequencer Tracks . . . . .	5 - 29
Recording Program Changes . . . . .	5 - 29
Assigning a Track to the Aux Outputs . . . . .	5 - 30
Using the Aux Outputs as Separate Mono Outs . . . . .	5 - 31
Track Volume Functions — Mixing, Muting, Soloing Tracks . . . . .	5 - 31
Song Mode:	
Switching Effects in Song Mode . . . . .	5 - 32
Song Tracks . . . . .	5 - 33
Viewing Sequence Tracks in Song Mode . . . . .	5 - 34
Mixing Down Sequence and Song Tracks in Song Mode . . . . .	5 - 35
Notes about Mixdown Mode . . . . .	5 - 36

## Introduction

With the ESQ-1, ENSONIQ became the first company to build a powerful multi-track sequencer into a keyboard instrument. The VFX<sup>SD</sup> with its 24-track sequencer represents the continuation of ENSONIQ's leadership in this area. The VFX<sup>SD</sup> sequencer incorporates a range of features and capabilities you would expect to find in stand-alone or computer sequencers, yet with the advantage of an integrated system.

As the first true Music Production Synthesizer, the VFX<sup>SD</sup> is both powerful and easy to use — having your synthesizer, sequencer and master keyboard controller right at your fingertips in one unit is what makes the ENSONIQ approach to digital sequencing so intuitive and efficient.

If you can't wait to start sequencing, you can turn right to "Recording a Sequence" later in this section. We recommend, however, that you come back and familiarize yourself with the many other sequencer controls and functions described in this section. This is the only way to truly take advantage of the power of the VFX<sup>SD</sup> sequencer.

## The MIDI Connection

Almost everyone is familiar by now with MIDI — that magical connection that lets you play one instrument (or a whole roomful of them) from another. MIDI — Musical Instrument Digital Interface — is a standard that has been agreed upon by manufacturers for translating musical events into specific numbers which are transmitted and received by MIDI instruments.

When you play middle C on the VFX<sup>SD</sup>, for instance, it instantly sends to its MIDI Out jack a series of numbers representing a *Key Down* event, along with the location of the note on the keyboard and how hard the key was struck. When you release the key the VFX<sup>SD</sup> sends a number meaning *Key Up*. A MIDI instrument connected to the VFX<sup>SD</sup> can receive and translate those numbers, and will play the middle C itself. The same thing happens whenever you move a controller, such as the pitch or MOD wheel, or when you select a new sound — each of these events is translated into a series of numbers which are transmitted by the MIDI Out jack.

## Digital Sequencing

Now imagine a recorder which, instead of recording the sounds of an instrument, records the same kind of digital information that is sent and received over MIDI — key down, key up, key number and velocity, pitch bend, mod wheel, program changes and so on — and you have imagined a *digital sequencer*.

A sequencer records and plays back the "control information" rather than the actual notes. This means that there is no degradation of the sound in the recording process no matter how many times you overdub or re-record a part. A sequencer is sort of like an electronic player piano.

It is important to bear in mind that a sequencer only records what you play. Sequencer memory is used up on the basis of *Events* (keys struck, controllers, etc.), while a tape recorder's memory (the tape) is always used up by the same amount over a fixed period of time.

This means that a sequencer will use virtually the same amount of memory to record 100 notes, whether you play those notes over ten seconds or ten minutes.

When you strike a key, the sequencer records a *Key Down* event. It then counts the *clock* pulses until you release the key, when it records a *Key Up* event. The amount of time between the key down and the key up doesn't really affect the amount of memory required to record the note. Compare this to an audio tape recorder. With tape, *time* is the thing. A tape recorder will use the same amount of tape to record a minute of music, whether the signal contains one note or one hundred.

You might say that tape is *linear* — it is spent at a fixed rate — while digital sequencer memory is *dynamic* — it is used only as needed. Understanding the difference will help you to manage the VFX<sup>SD</sup> sequencer memory. For example, while key events (the notes you play) use up relatively little memory each, controllers such as pressure, mod wheel, pitch bend, etc., are recorded as a flood of numbers which can fill up the memory in a hurry. Thus if you're trying to squeeze one more track into a sequence when there is not much memory left, you know to go easy on the controllers.

### Loading the Sequencer Operating System from Disk

The VFX<sup>SD</sup> Sequencer Operating System (or O.S.) is the computer program which controls the operation of the sequencer. Because it is contained in RAM and can be loaded from a disk, the VFX<sup>SD</sup> sequencer can be upgraded, its functions enhanced and new features added, as easily as loading a new sequence.

There are two times when you will need to load the Sequencer Operating System:

- When an updated version is released. New Sequencer O.S. disks can be obtained from your authorized ENSONIQ dealer as they become available.
- If some unforeseen event or system error should corrupt the sequencer memory, the VFX<sup>SD</sup> will flash SEQUENCER MUST BE LOADED whenever you press any of the buttons in the Sequencer section of the front panel.

To Load the Sequencer O.S. from disk:

- Insert the disk containing the most current Sequencer O.S. into the disk drive.
- Press **Storage**, then select DISK.
- Press LOAD. The display shows the Disk Load page, with the File Type selected.
- Move the data entry slider all the way up to select TYPE=SEQUENCER OS. The display should show:

```

LOAD  FILE=VERSION-1.0  SIZE=7  *YES*
      TYPE=SEQUENCER-OS  *NO *

```

The version number of the operating system on the disk is shown in the File Name. You should always use the most current Sequencer O.S. version.

- Press \*YES\*.
- The display warns SEQUENCER DATA WILL BE ERASED. If you have any valuable sequencer data in memory that needs to be saved, press \*NO\* at this point and save it before proceeding. Otherwise,
- Press \*YES\*. The Display reads LOADING VERSION ##, then returns to the Disk Load page where you can load any other files you wish. Press \*NO\* or any other front panel button to exit.

**What is a Sequence?**

A Sequence on the VFX<sup>SD</sup> is a collection of 12 independent tracks and an effects program. Each track has its own sound program and complete set of track parameters (volume, pan, timbre and all the other performance parameters, including MIDI channel, status, etc.) all of which are remembered with the sequence.

A sequence has a fixed length (though you can change it at any time) which is set by the length of the first track you record. A given sequence can be as short or as long as you like (within the limitations of memory).

Each sequence has an eleven-character name which you assign to it at the time of its creation. The name can be changed at any time from the Info sub-page of the Edit Sequence page.

When you select a new sequence, each track used within a sequence will send out a MIDI program change and MIDI volume instructions on its designated MIDI channel, unless the track has been assigned LOCAL only status — in which case you can have the new track play a new internal program.

**What is a Song?**

In Song Mode, sequences are assigned to play consecutively in any order, with up to 99 *Steps*, and up to 99 *Repetitions* of each Step. Within each Song Step, individual tracks within the sequence can be muted or transposed.

But a Song on the VFX<sup>SD</sup> is much more than just a collection of sequences playing in order. This is because each song has an additional set of 12 tracks which are completely independent of the tracks in its component sequences.

Each *Song Track* has its own sound program and a full set of track/performance parameters, just like a sequence track. The length of the song tracks is defined by the combined length of the steps and repetitions which make up the song. Song tracks are selected from the *Tracks 1-6* and *7-12* pages when a song is selected.

This means that after you have completed a number of sequences and linked them together to form a song, you have 12 more linear tracks which run the entire length of the song. This gives you 24 tracks to work with.

**Sequencer "Transport Controls"**

The three buttons at the bottom of the Sequencer section serve to start, stop and continue the sequencer, and to put it into Record and Overdub modes. In addition to these three buttons, the Auxiliary Foot Switch (available only when an optional SW-5 dual-pedal Foot Switch is connected to the VFX<sup>SD</sup>) can be used to start and stop the sequencer when both hands are busy.

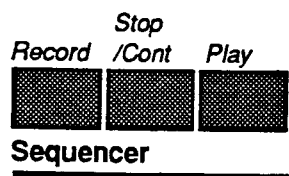

Aux. Foot Switch





Assuming the Autopunch function is off:

- Pressing **Play** will start the current sequence or song (whichever is selected) playing from the beginning.
- Pressing **Stop/Cont** will stop the sequencer (if pressed while it is running); or will play the current sequence or song from wherever it was last stopped (if pressed while the sequencer is stopped).
- The Auxiliary Foot Switch will duplicate the behavior of the **Stop/Cont** button.
- Pressing **Play** while holding down **Record** will start the sequencer recording on the current track from the beginning of the sequence or song.
- Pressing **Stop/Cont** while holding down **Record** will start the sequencer recording on the current track from wherever it was last stopped.
- Pressing **Record** while the sequencer is playing will put the sequencer into "Punch in" mode. It will wait for you to start playing before going into Record on the current track.

When the Autopunch function is on, the sequencer will only enter and exit Record mode at the points specified by the Edit Times on the Locate page.

### Sequencer Status

On most sequencer pages the lower-left-hand corner of the display indicates the *Sequencer Status*. The sequencer is always in one of the following states:

- STOP — Sequencer at rest
- PLAY — Playing current sequence (sequence selected)
- SNGS — Song Stop: sequencer at rest with a song selected
- SNGP — Song Play: playing current song
- REC — Recording on current track, first pass
- ODUB — Overdub: re-recording current track
- PLAY (flashing) — Countoff playing prior to going into Play, Record or Overdub
- REC (flashing) — Record Standby: waiting for you to play before going into Record (first track only)
- ODUB (flashing) — "Punch-in" Standby: waiting for you to play before going into Overdub
- MREC (flashing) — MIDI sync Record Standby: same as Record Standby except that the sequencer is synced to external MIDI clocks (CLOCK-MIDI on the Seq Control page) and is waiting for MIDI clocks as well as notes before going into Record.
- AUDP — Audition Play. This State is entered automatically from Record when the end of the sequence is reached (assuming LOOP=ON). After leaving Record and entering Audition Play, the sequence will continue to play in this state, with the newly recorded track, until you press the **Stop/Cont** button. Pressing **Stop/Cont** from this state will put you on the PLAY/KEEP Page (see below).
- AUDS — Audition Stop is entered when you stop the sequencer from the Audition Play state. To exit Audition Stop and return to the normal stop state, you must first instruct the VFX<sup>SD</sup> to KEEP either the new or the original track (see PLAY/KEEP Page later in this section).

## Sequencer Banks

Pressing the *Seq* button located beneath the display puts the VFX<sup>SD</sup> into sequencer mode. The ten Bank buttons (labeled 0-9) will now select Sequencer Banks. Each bank contains six sequencer locations, any of which can contain a sequence or a song, or may be blank.

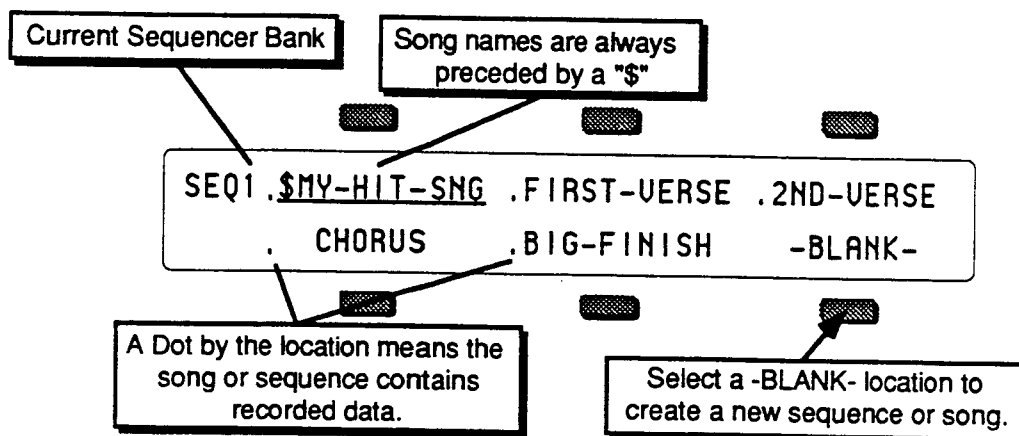

Song names always have a dollar sign (\$) as the first character, so that you can tell at a glance which locations contain sequences and which are songs.

The names of sequences and songs which contain actual recorded track data are preceded by a dot (.) on sequencer bank pages. Locations which have not yet been defined as a song or sequence show "-BLANK-".

Selecting an undefined (-BLANK-) field will initiate the Create New Sequence or Song function (see Creating New Sequence or Song, later in this section).

### Selecting a Sequence or Song

- Press *Seq*, then press the Bank buttons labeled 0-9 to see the ten Sequence Bank pages.
- Pressing the soft button next to any of the six locations on a page selects that as the current song or sequence.

When you select a song or sequence it becomes underlined. The currently selected song or sequence is always underlined.

### Playing Sequences and Songs

Try selecting a sequence, and pressing the *Play* button in the Sequencer section, to the right of the display. The selected sequence will begin to play.

While one sequence is playing you can select another one. An underline will begin to flash beneath the new sequence, but the original one will continue to play. When the first sequence is finished, the underline will switch to the new sequence, and it will play. In this fashion you can string sequences together in real time, as they play. The display always tells you which is playing (underline) and which is selected to play next (flashing underline).

Note that if the new sequence uses a different effect than the previous one, the audio output will be muted temporarily while the new algorithm is loaded.

Press the *Stop/Cont* Button or the *Aux* foot switch to stop the sequence.

## Sequencer Tracks

Each VFX<sup>SD</sup> sequence and song has twelve independent polyphonic *Tracks* on which you can record notes, controllers and program changes using local VFX<sup>SD</sup> sounds, remote MIDI instruments or both. These tracks are selected from the two Tracks pages, labeled *Tracks 1-6* and *Tracks 7-12*.

Let's take a look at the Tracks Pages:

Press *Tracks 1-6*. This takes you to the first of the two Tracks pages.

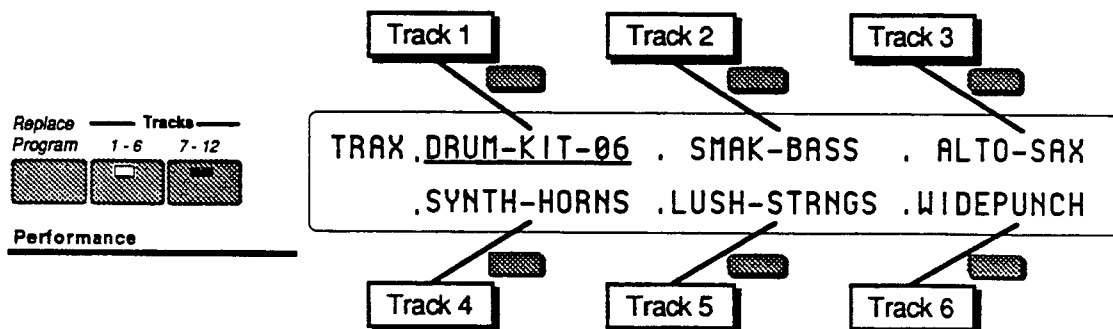

The LED in the *Tracks 1-6* button lights, and the display shows the names of the programs on the six tracks of the current song or sequence. Press the soft button next to a track to select that track.

The Tracks 7-12 page contains another six tracks. Press *Tracks 7-12*.

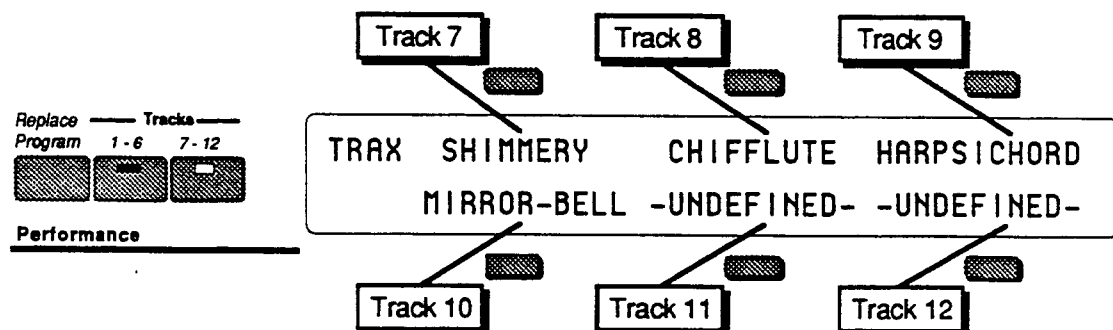

The LED in the *Tracks 7-12* button lights, and the display shows the names of the programs on the remaining 6 sequence tracks. Tracks which show `-UNDEFINED-` instead of a program name have not yet been defined (to define an undefined track you just select it).

A *Dot* to the left of the track location indicates that there is recorded data on the track.

On these two pages you can select and layer the tracks of a sequence (by clicking or double-clicking) just as you would on regular program bank pages. You can go back and forth between *Tracks 1-6* and *Tracks 7-12* without losing what was selected or layered in the other half. The LEDs in the two Tracks buttons tell you where you are.

### Replacing the Program on a Track

To replace the VFX<sup>SD</sup> program on a given track with a program of your choice:

- While on either of the Tracks pages select one of the six tracks.
- Press the **Replace Program** button. The display will show program bank pages, but the **Sounds** LED will blink, indicating that you are in Replace Program mode.
- Use the **Cart** button to choose between Internal, ROM or Cart sounds, as you would when selecting sounds normally.
- Use the Bank buttons to locate the bank containing the sound you want.
- Underline the program you want to put on the track.
- Press **Tracks 1-6** or **Tracks 7-12** to return to the Tracks page with the new program on the track. Note that all the performance parameters of the track (except for Timbre, Release and Pressure mode) are left just as they were previously. The values of those three Performance parameters are brought into the track with the sound, the other Performance parameters for a sequencer track are never altered unless you edit them intentionally.

To copy a program *along with* its effect into the sequence (replacing the current sequence effect with the one in the program), you follow the same procedure as above, with the addition of pressing the Performance **Effects** button while holding down **Replace Program** in the first step.

- Press **Tracks 1-6** or **Tracks 7-12** and select the track.
- Press and hold **Replace Program**.
- While holding down **Replace Program**, press Performance **Effects**.
- Use the Bank buttons and the soft buttons to pick a sound as before; but now each time you pick a new sound its effect will become the sequence effect.
- Press **Replace Program** again to exit Replace Program mode and return to the Tracks page to verify that your change was correct.

### Layering Programs on The Tracks Pages

In a preset a maximum of two programs may be layered with the selected program. Within a sequence, you can layer as many as 11 programs with the selected program. You can have up to 12 tracks layered (stacked) on one key, or up to 12 different tracks split across the keyboard by using the Key Zone function described in Section 3.

Layering programs is the same as in a normal Program Select page:

- Select a primary program on either of the Tracks pages.
- Double-click the soft button for the track you wish to layer. Layered tracks are identified by a blinking underline. If a track is layered, it can be un-layered by pressing its soft button.

### Sequencer Tracks and the Performance Parameters

Every sequencer track has a full set of Performance parameters which are saved with the sequence or song. The values of the following are remembered for each track:

- |                            |                  |
|----------------------------|------------------|
| • VOLUME                   | Track Control    |
| • PAN                      | • PATCH SELECT   |
| • TIMBRE                   | • PRESSURE type  |
| • KEY ZONE                 | • SUSTAIN enable |
| • TRANSPOSE                | MIDI             |
| • RELEASE time             | • STATUS         |
|                            | • CHANNEL        |
| • EFFECT - FX Bus override | • PROGRAM        |

You should refer to Section 3 for a full discussion of the performance/track parameters and their functions.

As described in the Section 2, whenever you go from Sounds or Preset mode to the Performance parameter pages, the VFX<sup>SD</sup> displays the names of the three most recently selected programs (on the top line) and their parameter values (on the bottom line).

Sequencer Tracks are similar, except that the names of the programs and their corresponding Performance parameters are shown on different pages. When you press *Tracks 1-6* or *Tracks 7-12*, the VFX<sup>SD</sup> displays the names of the six programs on those six tracks:

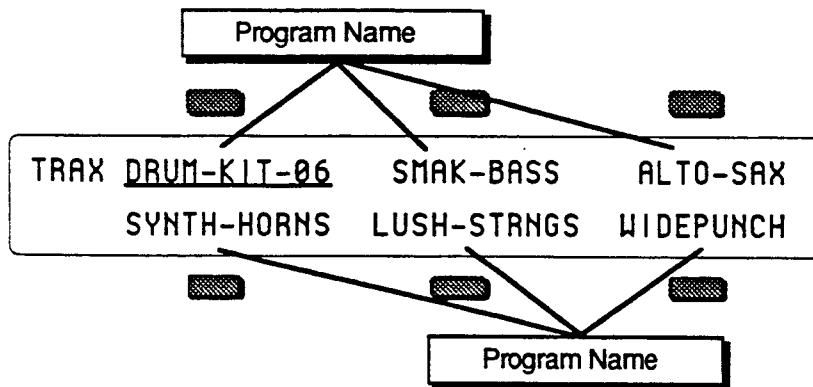

When you then select any of the Performance parameter pages, the display will show only the parameter values for the six tracks, and not the names of the programs:

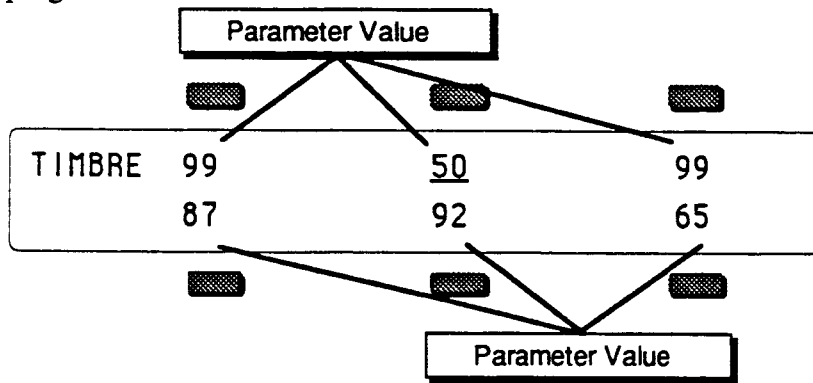

Let's look at a Sequencer Track Performance parameter, and you'll get a better idea how the works. Using the Volume page as an example:

- Press *Tracks 1-6* or *Tracks 7-12*. The display shows one the Tracks pages with the names of the programs on those six tracks.
- Press the *Timbre* button. This takes you to the TIMBRE Page.

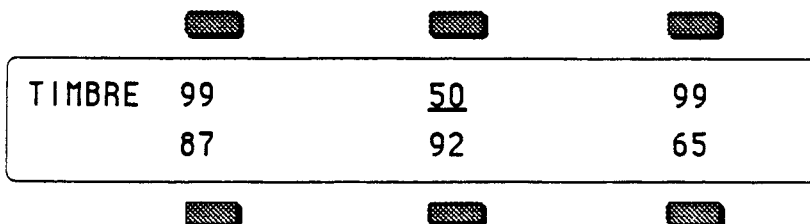

Each of the six parameter values corresponds to one of the 12 track locations (the LED in the *Tracks 1-6* or *Tracks 7-12* button will be lit to tell you which half you are in). You can verify this by pressing the *Timbre* button again. This enables you to toggle back and forth between the Performance parameter page and the TRAX page. Repeatedly pressing either the *Tracks 1-6* or *Tracks 7-12* button will also toggle you between the TRAX Page and the last-selected Performance parameter. This will help you keep track of what you're editing. Other than that, Performance parameter editing for a sequencer track is the same as for presets. All Performance parameter values are remembered for each track of each sequence and song.

**Important:** In Sequencer mode, selecting and editing a track from a Performance parameter page does *not* change what is selected or layered on the Tracks 1-6 and 7-12 pages — i.e. it does not affect what you hear when you play the keyboard. This means that you can edit a track parameter value for one (or more) of the tracks within a group of layered sounds without changing layer.

You can adjust volume, pan, timbre, etc. for tracks other than the selected track while playing back a sequence. However, this also means that you could edit a performance value for a track that you are not currently hearing from the keyboard, so be careful that you know what track(s) you are listening to in relation to what is selected on the Performance parameter pages.

The track that is selected on the Tracks 1-6 or 7-12 pages is the one that will be recorded if you go into record.

*You should get in the habit of always selecting a track from the Tracks 1-6 or Tracks 7-12 page before going into record.*

### Copying a Preset into 3 Sequencer Tracks

You can copy the three tracks of a preset, with all Performance parameter settings preserved, into three tracks of the current song or sequence. The preset will be copied whole into the three tracks on the upper or lower line of either the Tracks 1-6 or the Tracks 7-12 page:

- Press *Tracks 1-7* or *Tracks 7-12* and select any of the tracks on the line (upper or lower) to which you want to copy the preset.
- Press *Preset* and use the Bank buttons to select the preset you want to copy.
- Press and hold *Preset*. While holding the *Preset* button down, press the same Tracks button (1-6 or 7-12) as you did in the first step. The preset tracks are copied into the upper or lower line of that half of the TRAX page.

When you copy a preset into a sequence, the values of all the Performance parameters are copied. However, the selected and layered status of the tracks in the preset *is not* copied. Whichever tracks in the sequence are selected or layered when the preset is copied will remain so after it is copied. This also does not affect the track data in the sequence.







To copy a preset *along with* its effect into the sequence (replacing the current sequence effect with the one in the preset), you follow the same procedure as above, with the addition of pressing the Performance *Effects* button before pressing *Tracks 1-7* or *Tracks 7-12* in the last step.

- While holding the *Preset* button down, first press the Performance *Effects* button, then press *Tracks 1-7* or *Tracks 7-12*. The Preset is copied to three tracks of the sequence and its effect becomes the sequence effect.

## Creating a New Sequence or Song







Creating a new sequence or song is easy:

- On any of the Sequencer Bank pages, press the soft button nearest an undefined (BLANK) location will display the following prompt:







 CREATE NEW	 *SONG* -OR- *SEQUENCE*	
		*NO *
		

To Create a new sequence:

- Press the soft button above \*SEQUENCE\*. The display shows:

 CREATE SEQ	 NAME=SEQUENCE-20	 *YES*
	LEFT -CURSOR- RIGHT	*NO *
		

- Name the new sequence (or press \*YES\* to accept the default name). Under the first character is a cursor (underline). Use the data entry controls to edit the character, then use the cursor buttons beneath beneath the words LEFT and RIGHT to move the underline to another character and edit that. Continue this until the display shows the name you want. (Or you can use the keyboard to enter the name data if the Keyboard Naming function is enabled on the Master page.)
- Press \*YES\*. The display shows:

 CREATE NEW SEQ	 SEQUENCE-02	 *YES*
	WITH TIME SIGNATURE <u>4</u> /4	*NO *
		

- Set the Time Signature. The time signature is set at the creation of a new sequence and cannot be changed later. Use the data entry controls to adjust the top half of the fraction, then press the soft button beneath beneath the time signature to move the underline to bottom half, and adjust that.
- Press \*YES\*. The VFX<sup>SD</sup> returns to the current Sequencer Bank page with the new sequence selected.

To Create a new song:

- On any Sequencer Bank page, select a -BLANK- sequencer location, as described above. The display will show the CREATE NEW SONG/SEQUENCE screen.
- Press the soft button above \*SONG\*. The display shows:

CREATE SONG	NAME=\$SONG-01	*YES*
LEFT	-CURSOR-	RIGHT
		*NO *

- Song names are always preceded by "\$" to indicate their special nature. Note that you cannot change this \$ character. The other ten characters can be edited.
- Name the new song (or press \*YES\* to accept the default name, which is \$SONG-##). Use the data entry controls and the soft buttons labeled LEFT and RIGHT to edit the song name to create the name you desire.
  - Press \*YES\*. The VFX<sup>SD</sup> returns to the current Sequencer Bank page with the new song selected.

### Erasing All Sequencer Memory

When you want to erase all sequences and songs in the VFX<sup>SD</sup> sequencer memory, first make sure you have saved any important data to disk, then:

- Press and hold the *Presets* button.
- While holding down the *Presets* button, press the *middle* of the three soft buttons in the top row above the fluorescent display.
- The VFX<sup>SD</sup> asks: "ERASE ALL SEQUENCER MEMORY"
- Press \*YES\*. The VFX<sup>SD</sup> erases all sequences and songs from memory. After the memory is erased there will be one blank song and one blank sequence in locations 00 and 01. (There is always one song and one sequence in memory.)



## Click Page

Pressing the Sequencer *Click* button displays a page containing parameters which control the metronome functions of the sequencer.

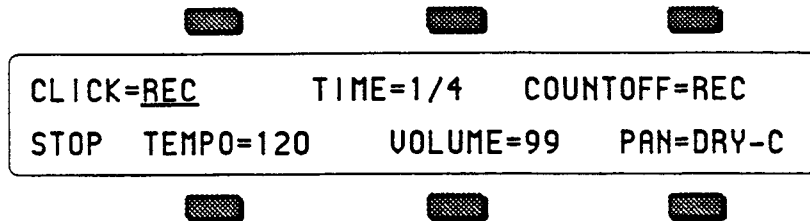

### CLICK

Controls whether or not the click will be heard.

- OFF — the click will not be heard in Play or Record modes.
- ON — the click will be heard whenever the sequencer is running.
- REC — the click will be heard only when the sequencer is in record mode, not when in Play.

### TIME

Sets the note value of the metronome click (range is 1/2 to 1/32T notes).

### COUNTOFF

This determines whether playing and/or recording sequences and songs will be preceded by a 1-bar countoff.

- OFF — no countoff will occur in Play or Record modes. The song or sequence will begin as soon as *Play* (or *Record/Play*) is pressed.
- ON — a one bar countoff plays before the sequence or song begins to play.
- REC — a one bar countoff will occur in Record mode only.
- QUIET — the countoff will occur in Play or Record modes without the click.

### VOLUME

Controls how loud the click will be.  
Range: 00 to 99

### PAN

Controls the stereo position of the click, and allows it to be sent out of the Main or Aux outputs.

- DRY-L, DRY-R and DRY-C will send the click (without effects) to the Main outputs, to the left only, right only or center respectively.
- AUX-L, AUX-R and AUX-C will send the click directly to the Aux outputs, to the left only, right only or center respectively.

### TEMPO

Sets the tempo of the current sequence. Range: 25 to 250 BPM (beats per minute).

### Tap Tempo

On any of the three pages where tempo appears (*Click*, *Seq Control* and *Locate*), the soft button below the TEMPO field can be used to "tap" in the tempo. If the field is already selected, tapping on the soft button at the correct rate for the desired tempo (based on the metronome settings on the click page) will update the tempo to the new value.

## Seq Control Page

The *Seq Control* page displays contains parameters which control the basic operation of the sequencer. This page contains consists of three sub-pages.

- Press *Seq Control*. The display shows:

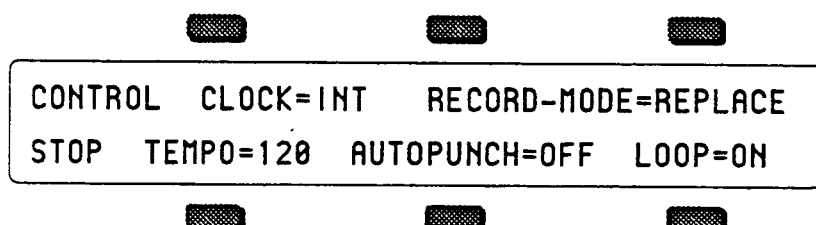

### CLOCK — Sequencer Clock Source

This parameter selects the clock source for the sequencer.

- INT — Selects the VFX<sup>SD</sup>'s own internal clock to run the sequencer. The VFX<sup>SD</sup> features 96 ppq (pulses per quarter-note) resolution for extremely accurate recording.
- MIDI — Selects external MIDI clocks as the sequencer clock source. Use this setting if you want to use another device (such as a computer sequencer or drum machine) as the master clock source and sync the VFX<sup>SD</sup> to it. Whenever CLOCK=MIDI, the tempo display will read TEMPO=EXT to indicate that the VFX<sup>SD</sup> is syncing to an external clock source.

### RECORD-MODE

Selects between the three recording modes for the sequencer.

- REPLACE — Anything recorded into an existing track will replace the data that was in the track previously. The sequencer will stop recording after one time through the sequence or song and will enter Audition/Play mode.
- ADD — New data recorded into an existing track will be added to (or merged with) data already in the track — the existing data will be left intact. Again, the sequencer will exit record after one time through the sequence or song and enter Audition/Play.
- LOOPED — As with ADD mode, new data recorded into an existing track will be added to (or merged with) data already in the track. However, when RECORD-MODE=LOOPED, the sequencer will remain in Record for as many times as you play the song or sequence through (rather than dropping out of Record after one time through). Think of this as "drum machine mode" — as long as the sequence or song keeps playing you can keep adding parts each time around.

There is a fourth Record Mode which is available only when a song is selected:

- MIXDOWN — When a song is selected on the VFX<sup>SD</sup>, you can set the Record Mode to MIXDOWN, which is used to record dynamic Volume and Pan changes into sequence and song tracks. When RECORD-MODE=MIXDOWN the VFX<sup>SD</sup> will record *only* changes made on the Volume and Pan pages in the Performance section. Notes, controllers, program changes, etc. will *not* be recorded in this mode.

Depending on the setting of the EDIT TRACKS parameter on the next sub-page (see below) you can mix down either the song tracks or sequence tracks over the length of the song.

**TEMPO**

Sets the tempo of the current sequence. When the sequencer is running you can tap on the soft button beneath this parameter at the tempo you want to install that as the current tempo. When CLOCK=MIDI, this display reads TEMPO=EXT. Range: 25 to 250 BPM (beats per minute) or EXT

**AUTOPUNCH**

This parameter controls an extremely powerful feature of the VFX<sup>SD</sup> — the Autopunch function. Autopunch means that when overdubbing a track, the VFX<sup>SD</sup> will automatically enter and exit record mode at predetermined times which you specify. You can play along with the track and have the VFX<sup>SD</sup> "punch" in and out for you like an invisible engineer. We refer to the points at which recording will begin and end as the *Edit Times* and they are set on the second sub-page of the Locate Page.

- ON — the VFX<sup>SD</sup> uses the Edit Times specified on the Locate sub-page for entering and exiting record state.
- OFF — normal recording without using Edit Times.

**LOOP**

This parameter controls whether or not the sequence or song will loop. The setting of this control is remembered for each sequence and song.

- ON — the sequence or song will play continuously, looping back to the beginning when it reaches the end.
- OFF — the song or sequence will not loop — it will play once and stop.
- Press *Seq Control* again to display the second sub-page.

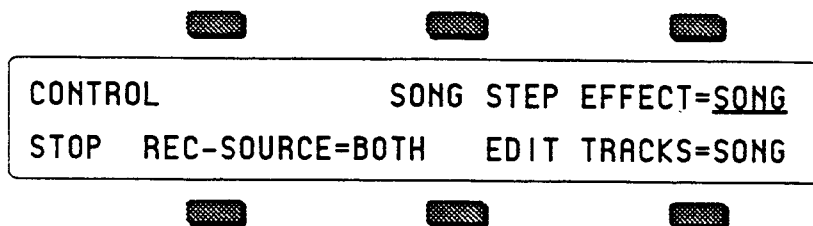
**SONG STEP EFFECT**

This controls which effect(s) will be used while a song is playing — those from each individual sequence or a single "override" effect saved with the song. A song contains a series of sequences which will play in order. Each sequence has its own effect. When switching from one sequence to another in the course of a song, there can be a momentary "glitch" of the sound as the effect for the new sequence is loaded. This can be avoided by setting this parameter to SONG STEP EFFECT=SONG so that the entire song will use the same effect.

- SEQ — the individual sequence effects will be selected as the sequences are played.
- SONG — the song effect will override the individual sequence effects.

**REC-SOURCE — Record Source**

This parameter determines what will be recorded when the MIDI mode is MULTI — data from the keyboard, from incoming MIDI, or both. Setting this parameter to MIDI is useful if you want to send data from the VFX<sup>SD</sup> to a MIDI processor, then record only the incoming data coming back from the processor. This parameter only has an effect in MULTI mode; in POLY or OMNI modes the sequencer always records both.

- BOTH — The sequencer will record data received either from the keyboard or from MIDI on the track's MIDI channel.

- **KYBD** — The sequencer will record data only from the keyboard.
- **MIDI** — The sequencer will record only data received from the MIDI on the track's MIDI channel.

## EDIT TRACKS

This determines which set of tracks will be displayed on the track parameter pages (Tracks 1-6 and 7-12, and the nine Performance/Track pages) when a song is selected. It also determines whether song or sequence tracks will be affected by volume or pan changes when you select Mixdown mode (see above). The default setting after a song is selected is SONG.

- **SEQ** — the sequence tracks from the current song step will be displayed. When EDIT TRACKS=SEQ and you press *Tracks 1-6* or *7-12*, the LED in the Tracks button will *flash* to remind you that you are looking at the tracks from the sequence currently playing and not at the song tracks.
- **SONG** — the song tracks will be displayed when a song is selected.

### Note:

When you are working with a song, you may want to switch back and forth between the Song and Sequence tracks without having to go to the Seq Control page. There is a shortcut for toggling this parameter between EDIT TRACKS=SEQ and EDIT TRACKS=SONG:

> While on either of the Tracks pages, *rapidly* double-click the *Tracks 1-6* or *Tracks 7-12* button. This switches between the song tracks and the sequence tracks, just as if you had changed the setting of the EDIT TRACKS parameter. The LED in the tracks button flashes when you are looking at sequence tracks; it remains solidly lit when the song tracks are displayed.

- Press *Seq Control* a third time to display the third sub-page.

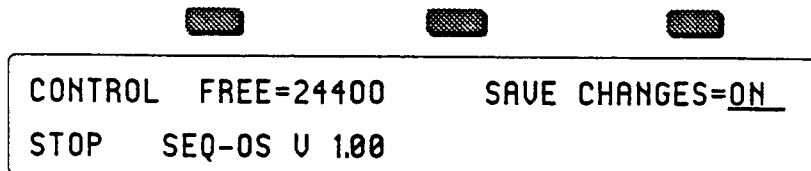

## FREE — Free Sequencer Memory (display only)

This shows the number of *events* of available sequencer memory. This readout is informational only and cannot be selected or changed.

## SAVE CHANGES

This parameter switches the VFX<sup>SD</sup> between sequencing mode, in which it assumes that you might want to save changes you make to the sequencer track parameters, and performance mode, in which you can change track parameters and then select a new sequence or song without the changes being saved.

- **OFF** — when SAVE CHANGES=OFF, you can edit any of the Track parameters, replace the program on a track, etc. and the changes will be "forgotten" as soon as you select a new sequence. Recording any new track data, however, will automatically reset this parameter to ON.
- **ON** — when SAVE CHANGES=ON, if you edit any of the Track parameters, replace the program on a track, etc. and then select a different sequence or song, you will be asked if you want to save those changes, as explained below.

## SEQ-OS — Sequencer Operating System Version

This shows the version number of the current Sequencer Operating System. This readout is informational only and cannot be selected or changed.

### About the SAVE CHANGES... Page

Along with the notes, controllers and program changes that are recorded on each track, there are many other parameters that are saved with each sequence or song. These are:

- the name of the sequence or song
- the tempo of the sequence or song
- the program assigned to each track on the Tracks 1-6 and 7-12 pages
- all Performance/Track parameters for each track of the sequence or song
- which tracks are selected and layered on the Tracks 1-6 and 7-12 pages
- the setting of the LOOP switch on the Seq Control page
- the setting of the CLICK parameter on the Click page

Whenever you record any track of a sequence or song, all of these values are automatically saved — that is, they will be remembered by the VFX<sup>SD</sup> if you leave the sequence (by selecting another one) and return to it later. However, if you change any of the above things, and then select a new sequence or song before you record any new track data, the following message will appear:

```

      [ ]      [ ]      [ ]

SAVE CHANGES TO <SEQ NAME> ?      *YES*
                                     *NO *
      [ ]      [ ]      [ ]
  
```

- Pressing **\*YES\*** saves the sequence or song, with the current settings of all the parameters listed above, into sequencer memory.
- Pressing **\*NO\*** leaves the settings of the parameters listed above as they were when you last recorded a track, or answered **\*YES\*** when exiting the same sequence.

In either case, the track data (notes, controllers and program changes) are always saved. Sometimes it's hard to remember, when you get this page, exactly what you changed. As a general rule, if you are happy with the sequence or song as it is, answer **\*YES\***. If you have just been experimenting with different tempos, programs, MIDI configurations, etc., and want to leave the sequence as it was before your experiments, answer **\*NO\***.

#### Hint:

There is one quick way to save any changes you make to a sequence or song. After you have changed any of the values listed above and want to save them, press the *Seq* button to return to the sequence bank page, and select the same sequence or song again. The display will ask "SAVE CHANGES TO <SEQ NAME>?" Answer **\*YES\*** and the changes you made to the sequence or song will be saved.

As mentioned above, you can avoid being asked to save changes by setting the SAVE CHANGES parameter to OFF. For live performance, and other applications in which you want to experiment with tempo, track parameters, etc. without being bothered about saving the changes, this is the preferred setting.

## Locate Page

Pressing the Sequencer *Locate* button displays a page which provides valuable sequencer information as well as control over tempo and Autolocate functions. Pressing *Locate* again will reveal the second sub-page where you can set the Edit Times for use with the Autopunch feature.

First we will look at the Locate page as it appears when a sequence is selected. When a song is selected, the Locate page is a little different (see below).

### Sequence Locate Page

- Select a sequence from one of the Sequencer Bank pages.
- Press *Locate*. When a sequence is selected, the Locate page shows:

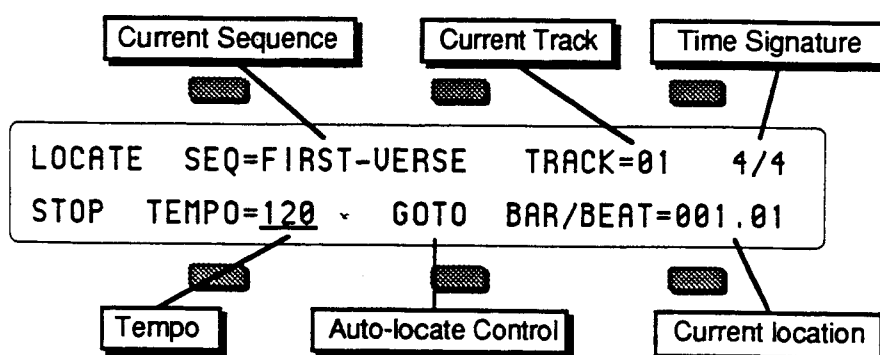

The status of the sequencer (whether it is in Play, Stop, Record, etc.) is always shown in the lower left-hand corner of the display on this page.

The following are *display only* parameters, provided here for your information:

- **SEQ** — shows the name of the current sequence.
- **TRACK** — shows the current primary/selected track. You cannot change the selected track from here; you do that from the Tracks 1-6 or 7-12 page.
- **Time Signature** — shows the time signature of the current sequence.
- **BAR/BEAT** — shows your current location in the sequence by bar and beat. You can locate to a different place in the sequence using the GOTO function described below.

The active controls on the Sequence Locate page are:

### TEMPO

Sets the tempo of the current sequence. This can be adjusted using the data entry controls or by *tapping* on the soft button below the tempo indicator whenever the tempo is selected.

When CLOCK=MIDI on the Seq Control page, this field will read TEMPO=EXT to indicate that the tempo is controlled by incoming MIDI clocks. Range= 25 to 250 BPM, or EXT.

### GOTO — Sequence Autolocate control

Displays the GOTO sub-page where the auto-locator destination is set. Using the GOTO function you can quickly locate to any bar and beat within the sequence, in order to play or record from there.

- Press GOTO. The display shows:

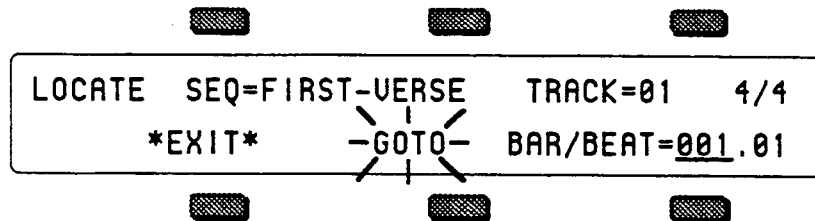

GOTO will be *flashing* and the destination may be set using the data entry slider or the up and down arrow buttons. Press the soft button beneath the Bar/Beat field to move the cursor between the Bar and Beat.

- Press the GOTO soft button again to complete the locating process and return to the main Locate page. The GOTO function provides a quick and easy way to repeatedly locate to a certain place in a sequence — the destination remains set until a new sequence or song is selected. Once the destination is set, simply press the GOTO button twice to locate to the same place.
- After using the GOTO function to locate to a spot in the sequence, press *Stop/Cont* to begin playing the sequence from that point.

### Song Locate Page

- Select a song from one of the Sequencer Bank pages.
- Press *Locate*. When a song is selected, the Locate page shows:

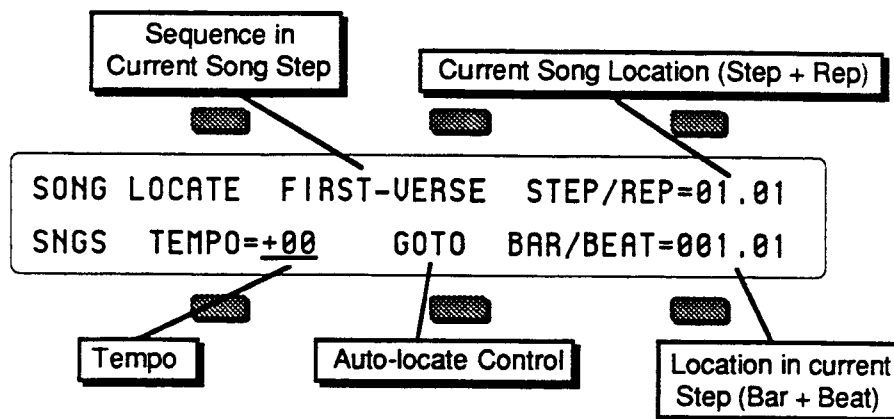

Note that the Sequencer Status (shown in the lower left corner of the display) now shows SNGS, for Song Stop, indicating that a song is selected.

The following are *display only* parameters, provided here for your information:

- **Sequence Name** — shows the name of the sequence which is playing as the current song step. This is updated with the new steps as the song plays.
- **STEP/REP** — shows your current location in the song by steps and repetitions. You can locate to a different place in the song using the GOTO function described below.
- **BAR/BEAT** — shows your location within the current song step by bar and beat. As with the song steps and reps, you can locate to a different point using the GOTO function.

The active controls on the Song Locate page are:

### TEMPO — Song Tempo Offset

This controls the tempo of the song. It is expressed as a percentage of the sequence tempo — changing the song tempo offset automatically adjusts the tempo of each the sequences in the song by +/-99%, within the legal limits of 25-250 BPM. When TEMPO=+00 the sequences will play at their designated tempo.

When CLOCK=MIDI on the Seq Control page, this field will read TEMPO=EXT to indicate that the tempo is being controlled by incoming MIDI clocks. Range= -99 to +99 BPM, or EXT.

### GOTO — Song Autolocate control

The GOTO sub-page looks a little different in song mode, as you can locate to any step or rep in the song, as well as to any bar and beat within the step.

- Press GOTO. The display shows:

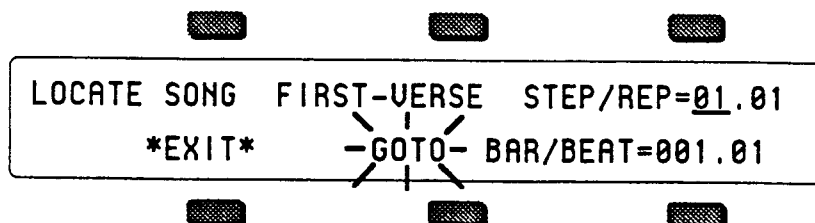

GOTO is flashing and the destination may be set using the data entry slider or the up and down arrow buttons.

- Press the soft button above the Step/Rep field to move the cursor between the Step and Repetition selecting the desired destination. Press the soft button beneath the Bar/Beat field to move the cursor between the Bar and Beat.
- Press GOTO again to complete the locating process and return to the main Locate page with the new location as the current one.
- After using the GOTO function to locate to a point in the song, press *Stop/Cont* to begin playing from that point.



**Edit Times — Using the Autopunch feature**

Press *Locate* a second time to display the Edit Times sub-page which contains the edit IN and OUT times. Press the soft buttons nearest IN and OUT to select the Edit Time parameters for editing. When a sequence is selected, the display shows the Bar, Beat and Clock at which the VFX<sup>SD</sup> will enter and exit record when Autopunch is on.

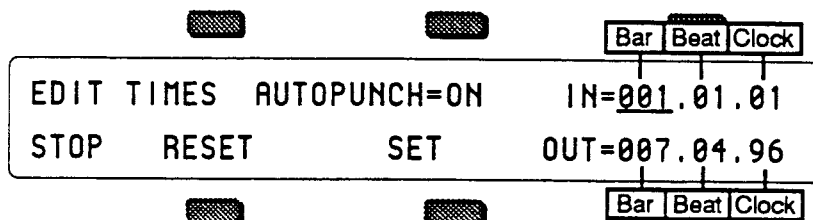

The edit times are set using the data entry slider or the up and down arrow buttons. Repeatedly pressing the soft button next to either time moves the cursor between the Bar, Beat and Clock. The SET and RESET buttons are also used to change the currently selected time value.

These times are automatically set to their default values (the beginning and end of the sequence or song) when a new sequence is created. If other values are installed, they will remain in effect until they are reset or a different sequence or song is selected. The current Edit Times are remembered for each sequence.

When the Autopunch function is on, the VFX<sup>SD</sup> will enter and exit record only at the points specified by the Edit Times. For example, if you want to have the VFX<sup>SD</sup> automatically record over just the third bar of a four bar sequence:

- Select the Autopunch parameter and set to AUTOPUNCH=ON.
- Select the IN Edit Time and set to IN = 003.01.01 (bar 3, beat 1, clock 1)
- Select the OUT Edit Time and set to IN = 003.04.96 (bar 3, beat 4, clock 96)
- Press *Record/Play* and play along with the track. The VFX<sup>SD</sup> will automatically enter record at the first clock of the third bar and exit record on the last clock of the third bar.

**AUTOPUNCH**

This is the same parameter found on the Seq Control page — it is also located on this page so that you have a handy way to enable or disable the Autopunch function on the same page where the Edit Times are located. See "Seq Control page" earlier in this section for a full discussion.

- ON — the VFX<sup>SD</sup> uses the Edit Times for entering and exiting record state.
- OFF — normal recording without using Edit Times.

**RESET**

Pressing this soft button resets the currently selected time to its default value. IN is reset to 001.01.00, or the beginning of the sequence, and OUT is reset to the time value for the last clock of the sequence.

**SET**

This sets the selected time to the current sequencer time value (as shown on the Locate page) if the sequencer is running. If the sequencer is stopped, the most recent time value is used. Using the Locate function does affect the current time value.

### Edit Times in Song Mode

You can use the Auto-punch mode and Edit Times to punch in and out on the song tracks as well as sequence tracks. When a song is selected, pressing *Locate* twice shows the following:

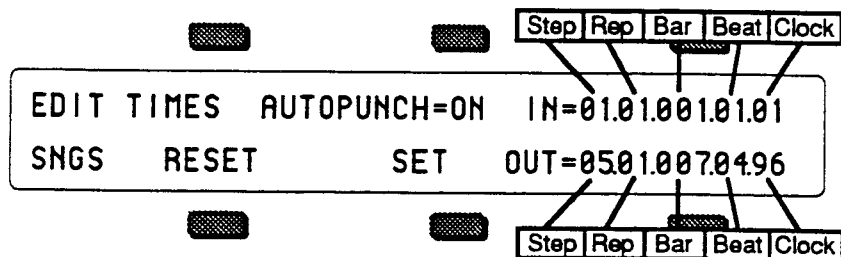

Notice that two more numbers are added to the Edit Times: the Song Step number and the Repetition of that step are added to the Bar, Beat and Clock within the sequence that plays during the step. You can set the IN or OUT time to any point within the song.

### Setting the Edit Times in Real Time

If you know the exact bar, beat and clock (or step, rep, bar, beat and clock in song mode) at which you want to punch in and out, you can simply select and set the Edit Times using the data entry controls. If not, you can set them "on the fly" using the following procedure:

- Press the soft button above IN to select the IN Edit Time.
- Press *Play* to begin playing the sequence or song.
- When the sequence or song reaches the point where you want to punch in, press SET. This installs that time as the IN Edit Time and moves the underline to OUT.
- At the point where you want to punch out, press SET again. This installs that time as the OUT Edit Time and moves the underline back to IN.
- Now, assuming Autopunch is on, you can go into record and play along with the track, and the VFX<sup>SD</sup> will automatically enter and exit record at those points which you chose.

## Recording a Sequence

Here we will describe recording a new sequence from scratch. First we will concentrate on sequencing with the VFX<sup>SD</sup> alone, and then cover sequencing remote MIDI instruments.

### 1) Create a New Sequence:

- Following the steps outlined earlier in this section, create a new sequence.

### 2) Select a Track:

- Press the *Tracks 1-6* button. The display shows the first six tracks of the new sequence. Track 1 is already defined and selected (there is always one track selected in a sequence) and the current program has been placed on the track. All other tracks are as yet -UNDEFINED-.

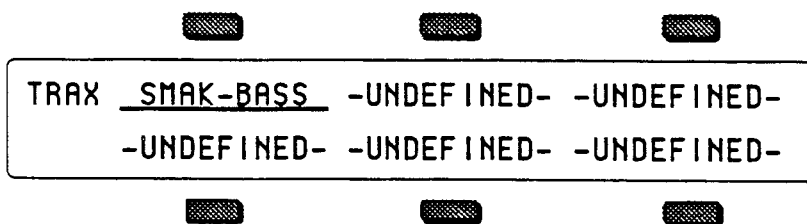

- If you want begin recording the sequence with a track other than Track 1, press the soft button next to that track. This defines the track and puts the currently selected sound on it. Otherwise, you can just leave Track 1 selected and start from there.

### 3) Select a Sound for the Track:

- Press *Replace Program*. The display shows Program Bank pages; the *Sounds* LED is flashing.
- Select a sound as you normally would, using the *Cart* button and the ten bank buttons to locate the sound you want, and then selecting it by pressing its soft button.
- Press *Replace Program* again to return to the Tracks page. The new sound is now assigned to the track.

### 4) Check the CLICK and COUNTOFF settings:

- Press *Click*. This page controls all the functions of the VFX<sup>SD</sup>'s built-in metronome. Underline the CLICK parameter and set to CLICK=REC. This will provide a click track when you are in record, but not during playback.
- Underline the COUNTOFF parameter and set to COUNTOFF=REC. This will play a one bar countoff before recording (but not when playing back) all tracks after the first.

### 5) Record the First Track:

The length of the first track defines the length of the sequence. For this reason, there is a special procedure for recording the first track of a new sequence.

- While holding down *Record*, press *Play*. The click track starts playing, giving the tempo. The first beat of each measure is emphasized.
- Adjust the Tempo. Press *Locate*. The Tempo parameter is always selected on this page. Use the data entry slider and the up and down arrow buttons to set it to the tempo you want. Or, with the sequencer running, you can tap on the soft button below the Tempo parameter at the desired tempo.
- Play the keyboard to commence recording. The bar in which you start playing

becomes Bar 1 of the Sequence.

- Press **Stop/Cont** (or the Aux. foot switch) to end recording. The display will ask "KEEP FIRST TRACK?" The length (in bars) of the first track is shown in the lower left corner of the display. This will determine the length of the sequence.
- Press **\*YES\*** to keep the track, defining the length of the sequence, or
- Press **\*NO\*** to erase the first track and start over again.

#### 6) Record Additional Tracks:

After you have answered **\*YES\*** to the question "KEEP FIRST TRACK?," all other recording, including re-recording the first track, will follow the same basic routine. The length of the sequence is now defined (by the length of the first track). The rest of the tracks will automatically have the same length.

- Press the **Tracks 1-6** button, and select a second track by pressing the soft button of any **-UNDEFINED-** track (or leave the first track selected if you want to record over it). The name of the program and all the track parameters from the previous track are copied onto to the new track.
- Select a program for the track. As shown in step 3 above, use the Replace Program function to put the sound of your choice on the selected track.
- Press **Record/Play** to begin recording. The click track will play for one measure (assuming **COUNTOFF= REC** or **CLICK**) and then the sequencer will enter record mode. It will record whatever you play on the new track until: 1) the end of the sequence is reached, or 2) you press **Stop/Cont** (or hit the Aux. foot switch).

At the end of the sequence, the VFX<sup>SD</sup> will leave record mode and (assuming **LOOP=ON**) enter Audition Play mode.

- Press **Stop/Cont** or the Aux. foot switch to stop the Sequencer. This puts you onto the Play/Keep Page:

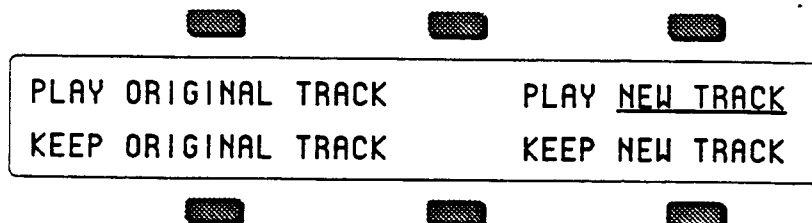

- Press **PLAY ORIGINAL TRACK** to hear the track as it was before you recorded the new track. The first time you record a particular track, this isn't very useful, but it is invaluable when you begin to do second and third takes, since it allows you to compare the tracks before deciding which to keep.
- Press **PLAY NEW TRACK** to hear what you just recorded.
- Press **KEEP ORIGINAL TRACK** to leave the track as it was in memory, and "burn" the one you just recorded. If the track was empty before recording, pressing this button will leave it empty.
- Press **KEEP NEW TRACK** to save the new track into memory, replacing whatever was on the track before.

The Play/Keep page appears after all track recording and after all track edit functions. The VFX<sup>SD</sup> always gives you a chance to audition changes to the track data before deciding whether to keep them.

**"Punching In" on a Track**

The VFX<sup>SD</sup> offers two methods for "punching in" (or re-recording) a specific part of a track. When the Autopunch function is *off* you can punch in manually just by playing the keyboard to start recording. When Autopunch is *on* the VFX<sup>SD</sup> will enter and exit Record mode automatically at the precise times that you specify on the Locate sub-page.

To Punch in manually on a track (meaning AUTOPUNCH=OFF on the Seq Control Page):

- Press *Tracks 1-6* or *7-12* and select the track you want to record on.
- Press *Play* to start the sequence or song playing.
- Press *Record*. This puts the VFX<sup>SD</sup> in Overdub Standby — ODUB flashes in the lower left corner of the display and the sequencer is waiting for you to play keys before going into record.
- Start playing at the point where you want to punch in. As soon as you play anything the VFX<sup>SD</sup> goes into overdub (or record for a new track) and records what you play, leaving intact the part of the track before the punch in. Unless you then press *Stop/Cont* or the Aux. foot switch, new track data will be recorded from the point where you punched in to the end of the sequence or song.
- Press *Stop/Cont*. You will see the PLAY/KEEP Page as shown earlier, letting you audition the new or the old track before deciding which to keep.

To Punch in and out automatically on a track (meaning AUTOPUNCH=ON on the Seq Control Page):

- Set the Edit IN and OUT times on the Locate sub-page as described earlier in this section. These define the exact bar, beat and clock at which the VFX<sup>SD</sup> will enter and exit record.
- Press *Record/Play* to start the sequencer. It will begin to play but will not go into record until the Edit IN time is reached. You can play along with the sequence if you wish without being recorded.
- When the Edit IN time is reached the sequencer will automatically enter record, and will record whatever you play until the Edit OUT time is reached.
- At the Edit OUT time the sequencer automatically exits record and goes into Audition Play mode.
- Audition the new track as usual from the Play/Keep page before deciding whether to keep the new or the old track.

When Autopunch is on, the VFX<sup>SD</sup> will record events *only* within the window of time specified by the Edit times, no matter how you enter record. Thus if you press *Play*, then *Record* the VFX<sup>SD</sup> will wait for you to play before entering record, but recording will only be triggered by notes within the Edit times window. Notes played before the Edit IN time or after the Edit OUT time will not initiate recording.

If the RECORD MODE=LOOPED (on the Seq Control page) and Autopunch is on, the sequencer will continue to go in and out of record at the Edit points each time the sequence repeats, for as long as you let it play.

### Playing along with a Sequence/Auditioning New Sounds

Whenever you go from Sequence mode to Sounds mode (by pressing the **Sounds** button), the VFX<sup>SD</sup> loads the effect for the current sound into the effects processor, replacing the sequence effect. (Remember, there is only one effects current at a time, and any voices that play will go through that effect.)

If you press **Sounds** while the sequencer is running, or press **Play** while in Sounds mode, you will hear the sequence or song played through the effect of the current sound. After that, as long as the sequencer is playing, choosing different sounds will not replace the effect that you hear — you will continue to hear everything through the effect of the first sound. Also, while the sequencer is running, you *cannot* layer sounds by double-clicking on the Program pages.

The preferred way to audition new sounds, or to just play along while the sequencer is running, is to use Replace Program mode:

- On the Tracks 1-6 or Tracks 7-12 page, select an UNDEFINED track.
- Press **Replace Program**. This puts you onto the Program Banks pages in Replace Program mode (the **Sounds** LED flashing) where you can change sounds with changing the sequencer effect.
- Once you have found the sound you want, press **Replace Program** again to return to the Tracks page with the new sound on the track.

### MIDI Sequencing on the VFX<sup>SD</sup> — MIDI Connections

You can use the VFX<sup>SD</sup> sequencer to drive external MIDI instruments, greatly enhancing the number of available voices and timbres. A sequence or song track can be assigned MIDI status (on the MIDI page) so that it plays only out MIDI; LOCAL status, so that it will play only locally; or BOTH in which case it will play a local sound *and* send on its designated MIDI channel.

When sequencing multiple MIDI devices, first connect the various destination instruments to the VFX<sup>SD</sup>, and to each other, as shown here. Connect the MIDI Out jack of the VFX<sup>SD</sup> to the MIDI In jack of the first instrument. Then connect the MIDI Thru jack of the first instrument to the MIDI In jack of the second instrument. Connect the MIDI Thru jack of the second instrument to the MIDI In jack of the third instrument. And so on, for as many devices as you will be using.

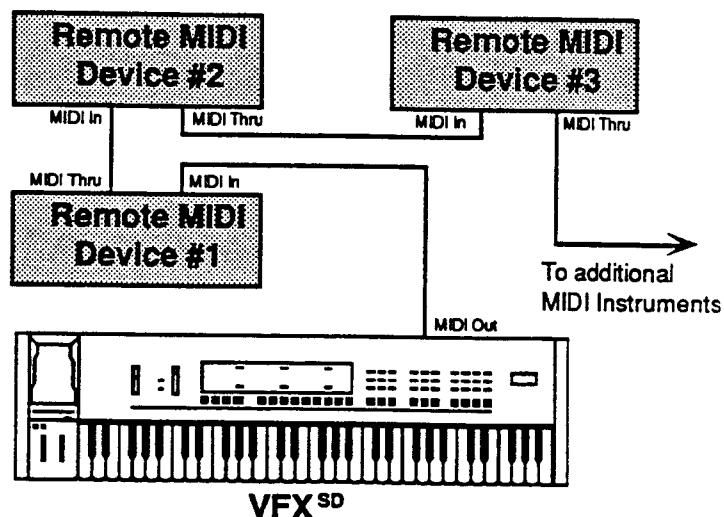

With this arrangement, once you set up the proper MIDI channels, etc. (see below), each device will receive and play only the data that is intended for it, and will "pass along" all other data. Also, each can be played from its own keyboard (as well as from the VFX<sup>SD</sup>'s) without affecting the others, because MIDI Thru jacks only pass along incoming MIDI data, and do not transmit what is played on the instrument.

This set up is ideal for controlling everything right from the VFX<sup>SD</sup>. Simply by selecting the track which is set to the same MIDI channel as to a particular instrument, you can:

- 1) Play that instrument from the VFX<sup>SD</sup> keyboard;
- 2) Record a track that will play back on that instrument when you play the sequence or song; and
- 3) Send the destination device Program Changes and adjust its volume (assuming the device receives MIDI Volume).

In other words, once you have made the appropriate connections, and set up the MIDI configuration of the tracks and all destination devices, you can use the VFX<sup>SD</sup>'s keyboard and its front panel to control and record all the instruments in your rig.

### MIDI Mode and Channel — Destination Instruments

The next step is to set up each destination instrument to receive only the MIDI information that is intended for it. When each of the receiving units is set to receive on a different MIDI channel (or a number of them, for multi-timbral units) you can control them all right from the VFX<sup>SD</sup>.

For each destination instrument:

- **Set to POLY (OMNI OFF) or MULTI Mode.** Each destination synth must be in a mode where it receives only on its selected MIDI channel (or channels). This is usually referred to as POLY (or OMNI OFF) Mode for receiving on a single channel, or MULTI mode for receiving independently on multiple channels. Consult the owner's manual if there is any question about a particular instrument.
- **Select a MIDI channel or channels.** The best idea is to assign each destination Instrument its own MIDI channel(s) and leave it that way. If you know, for instance, that a certain synth is always set to receive on MIDI channel 4, you can quickly set up a track to drive that synth by simply selecting an undefined track, then assigning that track MIDI Status and MIDI channel 4 on the Performance MIDI page. Also when each destination instrument is always set to its own distinct MIDI channel, it means that different sequences and songs recorded at different times will always play the right instrument on the right track.

Once you have assigned MIDI channels to each instrument in your rig, *write them down*, and keep the paper handy for quick reference.

### MIDI Track Configuration

After you have made the MIDI connections, and set up your destination instruments as described above, you now configure the tracks of a sequence to send to those instruments. Let's suppose that you are sequencing several external instruments, as depicted in the illustration on the previous page.

For each track which you want to drive a remote MIDI device:

- **Select a track.** Go to the *Tracks 1-6* or *Tracks 7-12* page and press the soft button corresponding to a track location to select a track.

- **Assign the track MIDI Status.** Press the Performance *MIDI* button once to display the STATUS sub-page. The selected track is underlined. Use the data entry controls to set the track to MIDI status. You will notice that when you play the keyboard now, it doesn't sound on the VFX<sup>SD</sup>.
- **Assign the track a MIDI Channel.** Press the Performance *MIDI* button again — the CHANNEL sub-page appears. Set the track to the MIDI channel of the instrument you want to sequence from that track. Playing the VFX<sup>SD</sup> keyboard should now play the Receiving Instrument.
- **Set the Program Number.** Press the Performance *MIDI* button a third time — the PROGRAM sub-page appears. Now you can use the data entry slider or the up and down arrow buttons to change the program that the receiving unit is playing. While playing the VFX<sup>SD</sup> Keyboard, adjust the program number until the external instrument is playing the sound you want.

From now on, whenever you select that sequence, or when it plays as a step in a song, this track will send out this program change on its selected MIDI channel.

**Note:** When sequencing, you should always select the sounds for external instruments from the VFX<sup>SD</sup> as described above, and *not* from the external instrument itself. This assures that the track has the proper program number for that instrument in each sequence.

### Recording MIDI Tracks

Once everything is set up, you can proceed with recording MIDI tracks exactly as you would for tracks with LOCAL or BOTH status. Tracks that are sent out MIDI are treated the same as internal tracks in terms of recording, overdubbing, punching in, editing, etc. Follow the same steps outlined earlier in this section for recording the first track and then for additional tracks.

For each successive track you record, the procedure will follow the same lines:

- 1) Define the MIDI configuration of the track on the Performance MIDI page,
- 2) Record the track, and then
- 3) Either keep or reject the new track from the PLAY/KEEP Page.

MIDI tracks can be selected and stacked from the Tracks pages, and can be muted or soloed from the Volume page, the same as any other tracks. Performance/Track parameters such as Volume, Key Zone and Transpose all apply to MIDI tracks just as with LOCAL tracks.

Most often you will be recording sequences and songs which contain some MIDI tracks and some LOCAL tracks. When this is the case, be sure that you assign LOCAL status (as opposed to BOTH) to the tracks that you want to play only on the VFX<sup>SD</sup>. This will avoid accidentally sending unintended MIDI data to an external instrument.



## Additional Sequencer Functions:

### Recording Controllers into Sequencer Tracks

When recording sequencer tracks, the VFX<sup>SD</sup> will record all changes to controllers such as the pitch and mod wheels, pressure, foot pedal, patch selects, sustain foot switch, etc.

There are two other, less obvious, controllers which will be recorded into the track if they are changed while the track is being recorded — Timbre and Release. When the sequencer is in Record or Overdub mode, if you go to the Timbre or Release page and change the value for the current track, the changes will be recorded. When you play back the track you will notice that the screen is updated with the new value only on each quarter note. But don't worry; all the values you recorded between the screen updates are being played back by the track.

### Recording Program Changes

The VFX<sup>SD</sup> will record program changes into a song or sequence track, allowing you to change the sound that is playing on the track as the track plays. There are two ways to record program changes into a track. Both methods will have the same effect, but the first is best suited for LOCAL tracks, the second for MIDI tracks.

To record a program change into a LOCAL track:

- On the Seq Control page, set the Record Mode to RECORD-MODE= ADD.
- Press *Tracks 1-6* or *Tracks 7-12* and select the track on which you want to record the program change(s).
- Press *Replace Program*, and press the proper Bank button to locate the sound you want to change to. Don't select the sound yet, just leave its bank showing on the display.
- Hold down *Record* and press *Play* to start the sequencer recording.
- At the point where you want to insert the program change, press the soft button next to the new sound. The track will begin to play the new sound and the program change is inserted into the track.
- You can continue selecting new programs in this mode as long as the sequence is in record. Each time the change will be recorded.

To record a program change into a MIDI track:

- On the Seq Control page, set the Record Mode to RECORD-MODE= ADD.
- Press *Tracks 1-6* or *Tracks 7-12* and select the track on which you want to record the program change(s).
- Hold down *Record* and press *Play* to start the sequencer recording.
- Press and hold down the soft button next to the track on which you want to record the program change.
- While holding down the soft button, type the number of the program change on the Bank buttons beneath the display. For example, to record program change #12, press 1, then 2; to record program change #106, press 1, then 0, then 6; and so on.
- At the instant you want the program change recorded, *release* the soft button. The program change is recorded (and sent to the remote device) when the soft button is released, so you can type the number in advance and let the button go at the exact instant you want the program change sent.

To send/record a MIDI program change:

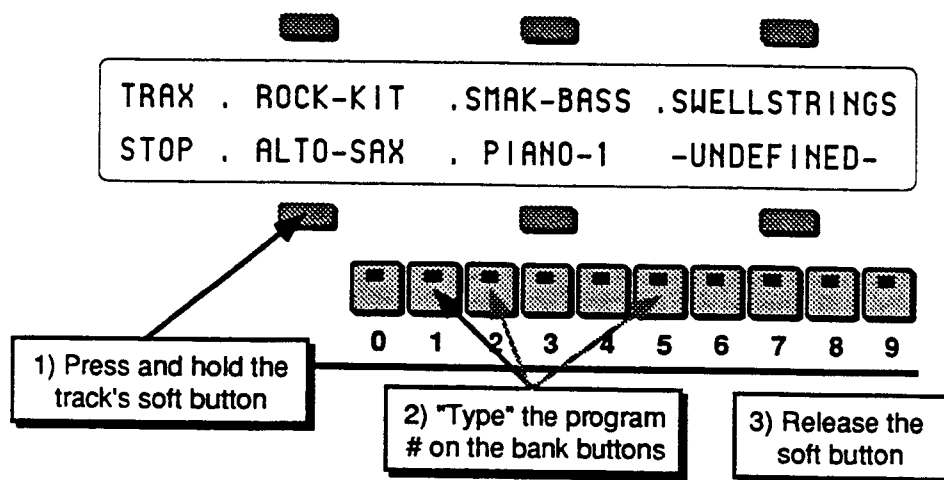

- This same procedure can be used at any time to send a program change to a remote MIDI device, whether the sequencer is in record or not.

**Note:**

If the track status is BOTH, program changes recorded into the track will affect both the local *and* the MIDI program when the track is played back. This is true whichever of the above methods was used to insert the program change, even though the second method shown above does not change the local program at the time of recording.

**Assigning a Track to the Aux Outputs**

Until you change it, each sequencer track will be sent to the output bus which is programmed into the sound. In almost all cases this means that the track will be sent to the Main stereo outputs. To assign a track to the Aux outputs for separate processing:

- Press *Tracks 1-6* or *Tracks 7-12* and select the track.
- Press the Performance *Effects* button directly above the Tracks buttons. The display shows the Effects Bus Override status for each track, with the current track underlined:

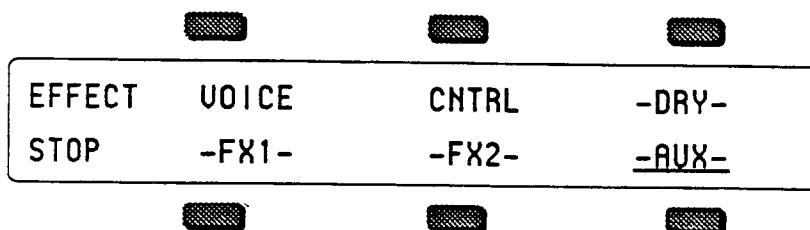

- Use the data entry controls to set the track to -AUX-. Anything played or recorded on that track will now be sent directly to the Aux outputs, bypassing the effects.

This page serves as a mixer for the various tracks, letting you determine how each track is routed to (or around) the effects. The available settings are:

- -DRY- forces all voices to the dry bus.
- -FX1- forces FX2 voices to FX1; FX1 and DRY are unaffected.
- -FX2- forces FX1 voices to FX2; FX2 and DRY are unaffected.

- **VOICE** uses normal voice routing as programmed into the sound, but controllers from the track are *not* routed to the effects.
- **CNTRL** uses normal voice routing and also routes controller information to the effect. This is the default setting in the track
- **-AUX-** forces all voices to the Aux outputs, bypassing the effects.

### Using the Aux Outputs as Separate Mono Outs







If you want to use the two Aux outputs as independent mono outputs, use the track Pan control in conjunction with the Effects Bus Override:

- Select a track, press the performance *Effects* button and assign the track to **-AUX-** as shown above.
- Press *Pan*. Set to +00 to assign the track to the left Aux output only; or set to +99 to assign the track to the right Aux output.

### Track Volume Functions — Mixing, Muting and Soloing Tracks

Once you have recorded a few tracks of a sequence you will want to balance the levels of the tracks, and maybe listen to them one or two at a time. This is done from the volume page.

Select a track from the Tracks 1-6 or 7-12 page, then press the *Volume* button. The display shows:

			
VOLUME	<u>99</u>	85	92
STOP	86	(99)	(99)
			

From this page, in addition to balancing the levels of the tracks in the sequence, you can solo and mute individual tracks just as you can with voices on the select voice page:

- Press the soft button corresponding to a track to select the track for editing. The data entry controls will now adjust the level of the selected track from 00 to 99.
- Press the soft button of the selected track again to *Mute* the track. Muted tracks will have brackets around the volume number, as in tracks 5 and 6 above. Pressing a muted track's button will un-mute it, removing the brackets.
- Rapidly double-click on a track's soft button to solo it. Asterisks will appear on either side of the soloed track, and all other tracks will get brackets to indicate that they are muted.
- Pressing the soft button of a soloed track will "un-solo" the track, returning all tracks to their previous status.
- When a track is soloed, you can select another track, then press its button again to "solo" it along with the other soloed track. In this way you can un-mute tracks one at a time to listen to any combination. Just press the soft button of any of the muted tracks again to return all tracks to their previous status.

## Song Mode

The VFX<sup>SD</sup>'s *Song Mode* is the key to unlocking its true power as a Music Production Synthesizer. In song mode you can chain a number of sequences together to form a song. Songs are made up of *Steps* — for each song step you can choose a sequence to play and the number of repetitions of that sequence, as well as mute and transpose status for each track of the sequence. The process for editing song steps is covered in Section 12.

But wait. There's more. Each VFX<sup>SD</sup> song also contains its own effects set-up (see below) and 12 additional tracks which are independent of the tracks in the component sequences that form the song steps. This gives you a 24 track sequencer with tremendous flexibility. You can choose which musical parts you want to put into the component sequences, and which parts you put in the song tracks. Discussion of song tracks begins on the next page.

### Switching Effects in Song Mode

As you are probably aware, when you are playing VFX<sup>SD</sup> sounds and you select a sound which uses a different effect from the previous one, there is a momentary muting of the audio output. This is because, like all digital signal processors, the VFX<sup>SD</sup> requires some time to switch from one effect to another. The software program which defines the effect must be changed for each different effect.

The same holds true when selecting sequences. Each sequence has its own effects set-up, which is completely programmable and is saved with the sequence. When you select a sequence, if the new one has a different effect than the previous one there will be a brief muting of the output.

This can pose a problem when playing a song — as a new song step begins to play, if the sequence in that step has a different effect than the previous one, there might be a muting of the audio output. Since it is usually not desirable during sequencer play to mute the output, the VFX<sup>SD</sup> offers some alternatives.

The parameter EFFECT=SEQ/SONG on the Seq Control page determines which effect(s) will be heard when a song is played:

- When EFFECT=SEQ, each time a new sequence begins as a step in a song, its effect will be loaded, resulting in a brief muting of the output (unless the new effect is the same as the previous sequence).
- When EFFECT=SONG, the effect which is stored in the song will be used for all the song steps and there will never be any muting or "glitching" of the output when new sequences play.

The setting of this parameter is saved with each song. Whenever a new song is created, it defaults to EFFECT=SONG. This ensures that there will be no output muting, but it also means that a sequence might sound different in a song than when it was played on its own.

If you do use the EFFECT=SEQ setting for a given song, you can minimize the muting by doing the following:

- Whenever possible, use the same effects algorithm in sequences which will be adjacent to each other in the song.
- Program a rest into the beginning of sequences where the effect will switch to a different algorithm from the previous one. Or create a silent one-bar sequence whose only function is to switch to a new effect. Then make sure the sequences that follow use the same effect.

**Song Tracks**

A Song on the VFX<sup>SD</sup> is much more than simply a group of sequences chained together. Once you have created a song and edited its steps, you can record another complete set of 12 song-length tracks. These *Song Tracks* are completely independent from the individual sequence tracks; each has its own program and complete set of track parameters. The length of the song tracks is determined by the combined length of the song's component sequences.

Let's suppose you have constructed a song, as described in Section 12. For our example we will take a simple case:

- You have recorded three sequences, each using up to 12 tracks, and combined those sequences into a song.
- Step 1 of the Song is Sequence 01 (a 4-bar Sequence) for 1 Repeat;
- Step 2 is Sequence 02 (an 8-bar Sequence) for 1 Repeat; and
- Step 3 is Sequence 03 (a 4-bar Sequence) for 1 Repeat.

Your Song would look like this:

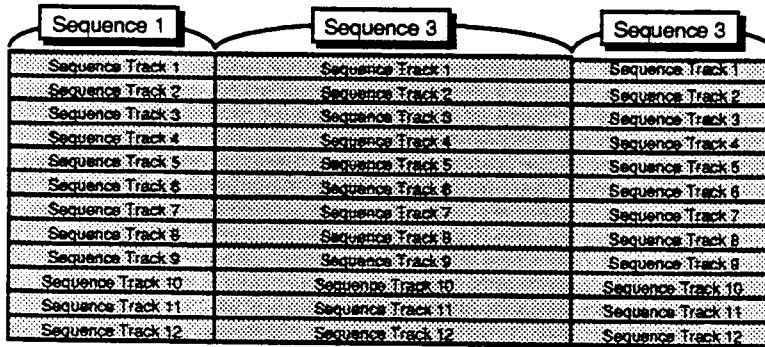

Now, with the song selected, you can press the *Tracks 1-6* and *7-12* buttons and see an entirely new set of empty tracks. These are the song tracks. Continuing with the above example, the song tracks might look like this:

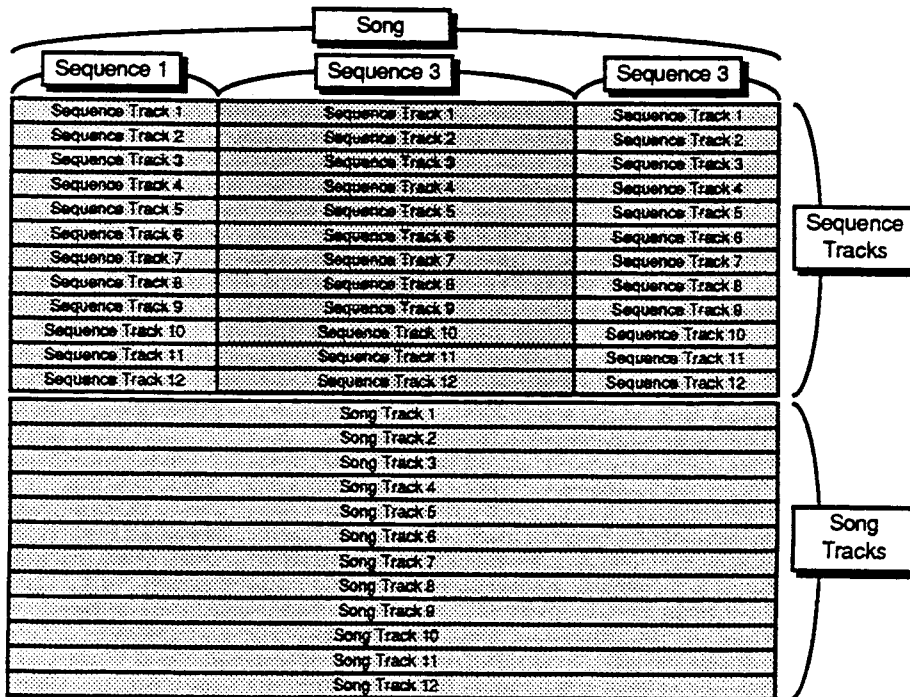

Song tracks are treated like normal sequence tracks whose length is equivalent to the combined length of all the sequences which make up the song. The length of the song tracks is set according to the song length at the time the first song track is recorded. Changes made to the song structure after the first song track is recorded will not affect the length of the song tracks.

- You can change the program on a song track using the Replace Program function, just as you would a sequence track.
- You can enter record (by holding down *Record* and pressing *Play*) and record on any of the twelve tracks. Follow the same procedures (as outlined earlier in this section) for recording song tracks that you would for sequence tracks. The only difference is that a song track is associated with the song itself and not with the individual sequences that comprise the song.
- You can edit the song tracks using any of the Track Edit functions discussed in Section 12. Selecting any Track Edit function when a song is selected will cause the current song track to be edited.
- You can use the Sequence Edit functions to edit the song tracks as a group, erasing them, adding and deleting bars, or copying the song tracks to another sequence. When a song is selected, the Sequence Edit functions will affect the song tracks, as if they were a sequence.
- You can solo, mute and adjust the volume of song tracks from the Performance Volume page as with sequence tracks.
- You can "mix down" the volume and pan of song tracks over the length of the song (see the description on the following page).

### Viewing Sequence Tracks in Song Mode

When a song is selected, what you see on the Tracks pages and the performance parameter pages depends on the setting of the EDIT TRACKS parameter on the Seq Control page.

- When EDIT TRACKS=SONG, the Tracks pages and the performance parameter pages will show the song tracks. Any changes you make will affect the song tracks only.
- When EDIT TRACKS=SEQ, the Tracks pages and the performance parameter pages will show the tracks for the individual sequences which make up the song steps. Any changes made to these tracks when a song is selected will *not* be remembered after the song step is done playing. To change anything about a sequence track you must first select the sequence and then change it there.

When a song is selected and EDIT-TRACKS=SEQ, the LED's in the *Tracks 1-6* and *7-12* buttons will *flash* to remind you that the track data is for the currently selected sequence in the song step and *not* the actual song tracks.

#### Note:

There is a shortcut for toggling this parameter between EDIT TRACKS= SEQ and EDIT TRACKS=SONG:

- While on either of the Tracks pages, *rapidly* double-click the *Tracks 1-6* or *Tracks 7-12* button. This switches between the song tracks and the sequence tracks, just as if you had changed the setting of the EDIT TRACKS parameter. The LED in the tracks button flashes when you are looking at sequence tracks; it remains solidly lit when the song tracks are displayed.

### Mixing Down Sequence and Song Tracks in Song Mode

After you have created and edited a song, you can "mix down" the volume and pan of the sequence tracks that make up the song steps, and of the song tracks themselves. The mixdown process does not affect the data in the individual sequences that compose the song steps; it creates a song-length *Mixdown Track* (which is actually a part of the song track) on which you can record volume and pan changes which will affect the sequence and/or song tracks over the course of the entire song. You can use this function to fine-tune the dynamics of certain tracks during part of a song, or to simply fade them out at the end of the song.

#### To record volume or pan changes to sequence tracks in a song:

- Select a song containing sequence tracks you want to mix down.
- Press *Tracks 1-6* or *Tracks 7-12* and select the song track corresponding to the sequence track you want to mix down. For example, if you want to record volume or pan changes to Track 3 of each sequence throughout the song, you must make sure that *song* track 3 is selected on the Tracks 1-6 page.
- Press *Seq Control*, select the Record Mode and set to RECORD MODE=MIXDOWN.
- Press *Seq Control* again and set the Edit Tracks parameter to EDIT TRACKS=SEQ (or, you can double-click the *Tracks 1-6* button; see above).
- Press *Tracks 1-6* or *Tracks 7-12* and select the sequence track you want to mix down.
- Press *Volume*. The display shows the volume levels for the tracks, with the current track underlined. (Or press *Pan* to record dynamic panning changes.)
- While holding down *Record*, press *Play*. The VFX<sup>SD</sup> enters Overdub.
- Use the data entry slider or the up and down arrow buttons mix the volume (or pan) of the selected track. All changes you make will be recorded.
- At the end of the song, or when you press *Stop/Cont*, the Play/Keep page appears. Here you can audition the changes before deciding whether to keep the new or the original track.
- To mix another track, press *Seq Control* twice and set the Edit Tracks parameter to EDIT TRACKS=SONG; press *Tracks 1-6* or *Tracks 7-12* and select a different track; then set the Edit Tracks parameter back to EDIT TRACKS=SEQ. Now press *Volume* or *Pan* and repeat the procedure.

#### To record volume or pan changes to a song track:

- Select a song containing song tracks you want to mix down.
- Press *Seq Control*, select the Record Mode and set to RECORD MODE=MIXDOWN.
- Press *Seq Control* again and set the Edit Tracks parameter to EDIT TRACKS=SONG. (Note that you can toggle between Song tracks and Sequence tracks in song mode by *double-clicking* the *Tracks 1-6* or *Tracks 7-12* button. See p. 5-35 in the Manual.)
- Press *Tracks 1-6* or *Tracks 7-12* and select the song track you want to mix down.
- Press *Volume*. The display shows the volume levels for the tracks, with the current track underlined. (Or press *Pan* to record dynamic panning changes.)
- While holding down *Record*, press *Play*. The VFX<sup>SD</sup> enters Overdub.
- Use the data entry slider or the up and down arrow buttons mix the volume (or pan) of the selected track. All changes you make will be recorded.
- At the end of the song, or when you press *Stop/Cont*, the Play/Keep page appears. Here you can audition the changes before deciding which to keep.

**Important:** The mixdown data is *always* recorded into the song track which is selected on the Tracks page, whether you are mixing a sequence track or a song track. You *must*, therefore, select the appropriate-numbered song track (while EDIT TRACKS=SONG on the Seq Control page) before entering Record, even if you then switch to EDIT TRACKS=SEQ to mix a Sequence track. For example if you want to mix down Sequence track 3 over the length of the song, you must have song track 3 selected.

#### A Few Notes About Mixdown Mode

Mixdown Volume and Mixdown Pan are recorded on the song track in a special form of ADD mode. When you record mixdown volume or pan, the information is *added* to the data in the song tracks (though it doesn't affect the song tracks, only the sequence tracks). This means that:

- If you have recorded Mixdown volume or pan into a track and want erase and re-record it, you must first remove the original volume or pan using the Filter command on the Edit Track page. Otherwise new mixdown information would be added to (and thus conflict with) the existing information.
- If you erase the song track, the mixdown volume and pan data will be lost. Recording notes, controllers, etc on the song track does not affect the mixdown information, but erasing the track (using the Erase command on the Edit Track) page will remove the mixdown data.

Whenever possible, you should use this function as the last step in the production chain, after you have finished changing the song length, recording and erasing song tracks, etc.

**Note:** The dynamic mixdown discussed here, which allows recording volume and pan changes over time, applies only to sequence and song tracks while in song mode. In sequence mode the settings on the Volume and Pan pages are saved for each track of the sequence, but the setting will not change over the course of the sequence.

You *can*, however, use the optional CVP-1 foot pedal to record volume changes into a sequence track while the sequence is selected. Just set to CV PEDAL=VOL on the Master page, and then record the foot pedal changes in ADD mode. This will record Volume (MIDI controller #7) messages into the track which are separate from the mixdown volume described above.



## Section 6 — System Control

- These parameters control instrument-wide system functions. You can save the settings on these two pages for quick recall by saving the System Set-up from the Storage page (see Section 11).

Master Page . . . . .	6 - 1
MIDI Control Page . . . . .	6 - 5

### Master Page

The Master Page has three sub-pages. These pages give you control over some of the VFX<sup>SD</sup>'s instrument-wide system parameters. The settings of these parameters will remain in effect at all times and are preserved while the power is off.

Press the *Master* button to display the first sub-page.

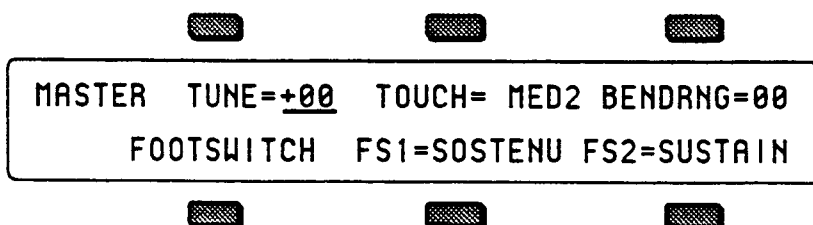

### TUNE

Adjusts the overall master tuning of the keyboard up or down as much as one semitone. A value of +00 will set the VFX<sup>SD</sup> to concert A=440 tuning.

Range: -99 to +99 cents.

### TOUCH

Allows you to adjust both the pressure *and* velocity response of the keyboard to match your playing style and technique. For each of the four velocity settings SOFT, MED, FIRM, HARD there are four pressure thresholds 1, 2, 3, 4, for a total of 16 available settings. The pressure threshold can be varied between 1 (minimum force required to bring in pressure) and 4 (maximum force required to bring in pressure).

- SOFT 1, SOFT 2, SOFT 3, SOFT 4—This is for someone with a light touch. On any of these settings, a minimum of velocity is required to reach the maximum level of any velocity-controlled parameter.
- MED 1 MED 2, MED 3, MED 4—Slightly harder keystrokes are required to reach maximum velocity levels. The pressure threshold is adjusted from MED-1 to MED-4 as described above.
- FIRM 1, FIRM 2, FIRM 3, FIRM 4—These settings represent average velocity sensitivity. One of these settings should be right for the player with an average touch. The pressure threshold is adjusted from FIRM 1 to FIRM 4 as described above.
- HARD 1, HARD 2, HARD 3, HARD 4—These settings are for the strong player who strikes the keys hard. It provides the widest possible range of

velocity sensitivity. The pressure threshold is adjusted from HARD 1 to HARD 4 as described above.

## BENDRNG

Adjusts the system pitch bend range, which is the maximum amount of pitch bend which can be applied with the pitchwheel. Each increment represents a semitone.

This bend range will apply to all programs *except* those which have been programmed to override the system bend range. If you set the system bend range, and a sound does not seem to pitch-bend the correct amount, check the setting of the BEND-RANGE parameter on the Program Control (PROG-CNTL) page for that particular program. If BEND-RANGE=\*\*, then the sound uses the system bend range. Otherwise, the sound has its own bend range and will ignore the system bend range.

Range: 0 to 12 semitones.

## FOOTSWITCH

Controls for setting the functions of any footswitch(es) connected to the Foot switch input of the VFX<sup>SD</sup>. There are two possible footswitches, FS1 (left) and FS2 (right or single).

### FS1

When the *optional* SW-5 dual foot switch is plugged into the VFX<sup>SD</sup>, the settings of this parameter will control the function of the left pedal.

- UNUSED — makes the VFX<sup>SD</sup> ignore the left footswitch.

*If you are are using the single footswitch which came with the VFX<sup>SD</sup> (SW-1), then you should keep this parameter set to UNUSED.*

- SOSTENU — makes the footswitch act almost like the sostenuto pedal on a piano. Any keys that are held down when you press the pedal are sustained until you release the pedal, but subsequent keys are not affected.
- PATCH L — makes the left pedal act like the left patch select button.
- ADVANCE — each time the footswitch is pressed, the VFX<sup>SD</sup> advances to the next Preset. When the next preset is in a different bank, the preset bank will also be switched. For example, at preset #9 of Bank A, it jumps to preset #0 of Bank B. At preset #9 of Bank B, it jumps to preset #0 of Cart Bank A. If no cart is installed, it jumps back to preset #0 of Bank A.
- STOP/GO — the footswitch will stop and continue the sequencer, exactly reproducing the actions of the *Stop/Cont* button on the front panel.

### FS2

Controls the function of the basic footswitch (SW-1), or when the *optional* SW-5 dual foot switch is plugged into the VFX<sup>SD</sup>, the settings of this parameter will control the function of the right pedal.

- SUSTAIN—holding the pedal down will cause notes to sustain after a key has been released, much like the sustain pedal on a piano.
- PATCH R—makes the right pedal act like the right patch select button.

Press the *Master* button again to display the second sub-page:

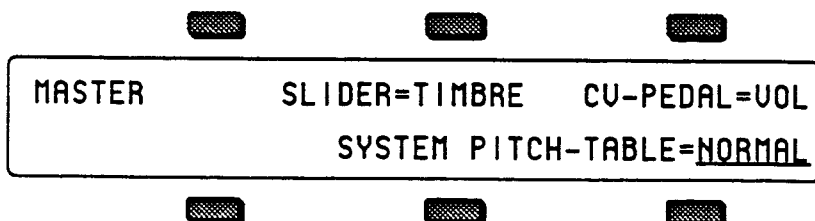

## SLIDER

Determines whether the data entry slider will act as a Timbre control while on any program bank page. This allows you to vary the timbre setting of the program without having to switch to the Timbre performance parameter page. Refer to the Performance Parameters section for more information about the Timbre control.

- **TIMBRE**—the data entry slider will control the Timbre setting of the primary selected program while any program bank page is displayed.
- **NORMAL**—the data entry slider will act normally, and will be disabled while on program bank pages.

## CV-PEDAL

Determines whether the optional CVP-1 foot pedal will act as a volume pedal or modulator.

- **VOL**—the foot pedal will adjust the volume of the VFX<sup>SD</sup>.
- **MOD**—the foot pedal will affect anything that has PEDAL selected as a modulation source.

## SYSTEM PITCH-TABLE

This parameter sets the type of system pitch table which will apply to all voices which have been programmed to use the SYSTEM pitch table. Please refer to the Using Pitch Tables section for more information.

- **NORMAL**—the VFX<sup>SD</sup> will use standard equal-temperament tuning instead of the custom system pitch-table. Setting the system pitch-table to NORMAL does *not* affect the custom pitch-table.
- **CUSTOM**—the system (or keyboard-wide) pitch-table is set to a user-definable tuning, which can be installed by using a special Copy function (see the Copy page section). This is useful when you have one alternate tuning scheme which you want to use for many programs
- Press *Master* a third time to show the third sub-page:

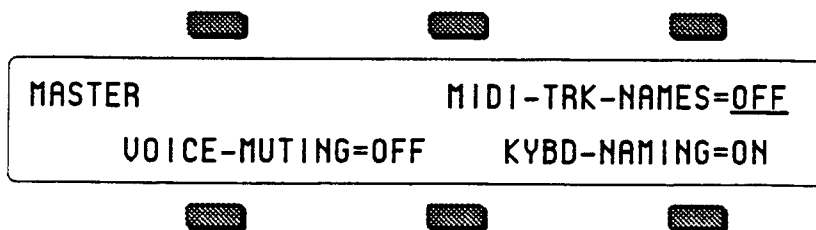

## MIDI-TRK-NAMES

This parameter determines whether preset and sequencer tracks which have MIDI status will show the the program name (as do LOCAL and BOTH tracks) or show \*MIDI-CHAN-# instead of the program name.

- OFF — When a track's status is set to MIDI or \*EXT\* on the Performance MIDI page, any displays which would normally show the track's program name (the Tracks 1-6 and 7-12 pages in sequence mode, and all performance parameter pages in preset mode) will show \*MIDI-CHAN-# instead of the name. This is helpful when using the VFX<sup>SD</sup> as a MIDI controller, or when sequencing remote MIDI devices, as it shows you at a glance which tracks are playing only over MIDI, and on which MIDI channels.
- ON — The track's program name will always appear on the Tracks 1-6 and 7-12 pages and the performance parameter pages (in preset mode) no matter what the track's status.

## KYBD-NAMING

When this switch is on, the keyboard can be used for name data entry. Whenever a name field is active, pressing a key on the keyboard will enter the character assigned to that key or move the cursor. The 36 white keys are the digits 0..9 and letters A..Z, while the black keys provide a repeating set consisting of cursor left, cursor right, and 3 punctuation marks (space, dash and plus). Period, slash and star are only available using the data entry slider or up and down arrows.

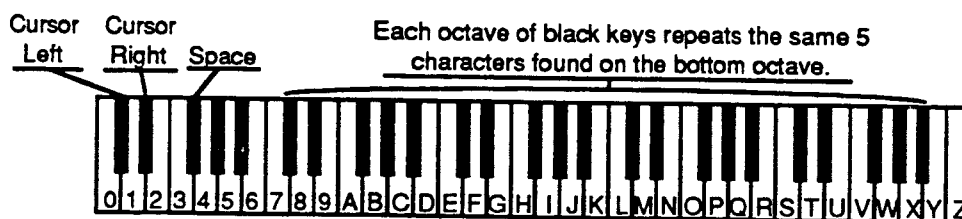

When KBD-NAMING=ON the keyboard naming function is available from:

- The Write page, for saving a single program to internal or cartridge memory;
- The Edit Song and Edit Seq INFO pages, for renaming songs and sequences;
- The Create New Song or Sequence pages, for naming new songs and sequences;
- The Disk Save function of the Storage page, for saving data to disk.

When KBD-NAMING=OFF, the characters on naming pages will be affected only by the data entry controls and the Move Cursor soft buttons.

## VOICE-MUTING

This parameter controls whether or not all voices currently playing will be shut off when a new program or preset is selected. This lets you avoid any audible "glitch" or discontinuity as the new sound's effect is loaded, but at the expense of being able to sustain a note from one sound while selecting and playing another.

- ON — Whenever you select a new sound or preset, any voices that might be sustaining from the previous sound will be stopped.
- OFF — When you select a new sound or preset, voices that are sustaining from previous sounds will continue to play as long as the key(s) are held down. The old voices will go through the effect of the new sound or preset, so they might sound different, especially if the new sound uses a radically different effect.

## MIDI Control Page

- Set system MIDI parameters, such as channel number and mode
- Control what types of MIDI messages are received and transmitted

Few developments in recent years have had as great an impact on the way we make music as has the emergence of MIDI. Whether you are simply linking two keyboards together, playing a synth from a guitar controller, or driving a rack of samplers from a drum pad controller, MIDI makes it all possible. The evolution of MIDI has facilitated the merging of existing technologies and has inspired the creation of new technologies. ENSONIQ has always been an industry leader in MIDI development, and the VFX<sup>SD</sup> embodies the latest advances in a state-of-the-art sequencer, controller keyboard and multi-timbral sound generator.

- Press the *MIDI Control* button. This takes you to the top level MIDI Page.

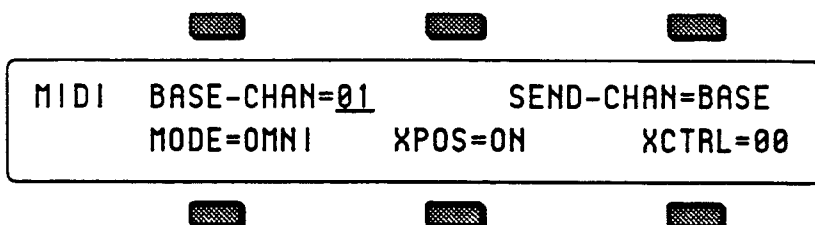

### BASE-CHAN

Selects the Base Channel on which the VFX<sup>SD</sup> transmits and receives MIDI messages. System Exclusive messages are always sent and received on the base channel.

Range: 01 to 16

Any of 16 MIDI channels may be selected as the basic MIDI channel of the VFX<sup>SD</sup>. The effect of setting the base channel varies depending on the MIDI Mode and whether data is being sent or received.

**Transmit** If SEND-CHAN=BASE, then the VFX<sup>SD</sup> only transmits on the base channel. If SEND-CHAN=TRACK then keys, controllers and program changes are transmitted on the channel defined in the preset or sequencer track.

**Receive** In Poly mode keys, controllers and program changes are only recognized if received on the base channel. In Mono A mode program changes are received only on the base channel. The base channel is also used in both Mono modes as the first channel of the 12 channel range.

### XPOS - MIDI Transpose Enable

Controls whether track transpose will affect the sending of MIDI key numbers.

- ON—the VFX<sup>SD</sup> will transmit the transposed key numbers of a track. Useful for sending transposed key numbers to an external MIDI device.
- OFF—the key number transmitted will be the same key that was actually played on the VFX<sup>SD</sup> keyboard. In this mode, the VFX<sup>SD</sup> will respond properly when data sent to an external sequencer is played back.

**SEND-CHAN**

This switch controls how the VFX<sup>SD</sup> determines the correct MIDI channel for transmitting performance information such as key and controller events, as well as program changes.

- **BASE**—The VFX<sup>SD</sup> will transmit *only* on the Base Channel, and will ignore the channel assignments contained in the tracks.
- **TRACK**—The settings in the track control MIDI transmit channel selection. The VFX<sup>SD</sup> will transmit on the channel(s) assigned to the track(s) being played, either from the keyboard or the sequencer, depending on MIDI Status (i.e. nothing will be sent if the track is assigned to LOCAL status). Each track can have its own MIDI program number and its own PRESSURE setting.

**XCTRL - External Controller**

Use XCTRL to assign external MIDI controllers to affect the VFX<sup>SD</sup>.

Range: 01 to 95

Most controllers on a synthesizer—mod wheel, channel pressure, or breath controller for example—have a MIDI controller number which can be assigned to this parameter. Doing so will make a particular external controller available as a modulator to any of your programs.

One of the modulation sources that can be selected in the programming section is XCTRL. The value of the XCTRL parameter is a MIDI controller number, ranging from 01 to 95. When the VFX<sup>SD</sup> receives MIDI Controller messages corresponding to this controller number, they will be routed to *all* parameters which have been programmed with XCTRL as a modulation source.

Suppose, for example, you are playing the VFX<sup>SD</sup> from a keyboard with a breath controller (or want to use a breath controller as a modulator when playing the VFX<sup>SD</sup> keyboard). You can set up a program on the VFX<sup>SD</sup> in which the filter cutoff frequency is modulated by XCTRL. If you then set XCTRL=02, the breath controller will now be able to modulate the filter, or whatever else has its modulation source set to XCTRL, in the program you have created.

The following controller numbers have been agreed upon as MIDI standards:

Number	Controller	Number	Controller
1	Modulation wheel	66	Sostenuto pedal
2	Breath controller	70	Patch selects
4	Foot pedal controller	92	Tremolo
6	Data entry slider	93	Chorus
7	Volume	94	Celeste
65	Sustain pedal	95	Phaser

Although the range of this control is from 01 to 95, most of the values other than those listed above have no "approved" accepted function, as yet. They are there to provide flexibility and to accommodate future MIDI standards.

**MODE — MIDI In Mode**

This parameter determines how MIDI information will be *received* by the VFX<sup>SD</sup>. MODE has no effect on what MIDI information is sent.

There are five MIDI modes implemented in the VFX<sup>SD</sup>:

- **OMNI**—In this mode the VFX<sup>SD</sup> will receive on any or all of the 16 MIDI channels. This mode is useful when you are only using a few instruments, and you are not concerned with setting up different channels for each device.
- **POLY**—In this mode the VFX<sup>SD</sup> will receive only on the Base MIDI channel. MIDI information on all other channels will be ignored.
- **MULTI**—An ENSONIQ innovation, MULTI mode is the key to unlocking the potential of the VFX<sup>SD</sup> as a multi-timbral receiver from an external MIDI sequencer. In MULTI mode the 12 Tracks of the current song or sequence can receive MIDI information independently and polyphonically on up to 12 different MIDI channels. You can easily create empty sequence templates for use in multi-channel reception; see Section 13 for details.

Different MIDI channels should be selected for each track which you want to receive. This can be accomplished on the MIDI Channel page (see the Performance MIDI section for more information).

In MULTI mode, independent of what programs are stacked or selected on the front panel, the sounds you hear will depend entirely on what MIDI channel(s) the MIDI data is received on.

**Mono Mode**

Mono mode is particularly useful for driving the VFX<sup>SD</sup> from a guitar controller, or any other application where having up to twelve independent, monophonic channels is desirable.

The VFX<sup>SD</sup> offers two types of Mono mode operation. In both types, the VFX<sup>SD</sup> will receive monophonically on twelve consecutive MIDI channels starting with the Base channel (the base channel through base channel +11). The difference has to do with how those MIDI channels are routed within the VFX<sup>SD</sup>.

- **MONO A**—This is another ENSONIQ development intended to make using multi-channel controllers like guitars easier. All notes and controllers received will play whatever programs are selected for the note that is played, just as if the note was played from the keyboard. You have the advantage of multiple tracks which will respond independently to controllers received on multiple channels, but you do not have to set up the programs for each track separately.
- **MONO B**—This is the more conventional type of Mono mode. It allows you to set up each track of the current song or sequence as a monophonic synthesizer. Each track can have a different program assigned to it. This is the only way to get a different sound on each string when using a MIDI guitar controller.

### Global Controllers in Mono Mode

Global controllers are controllers sent on one channel which affect all other channels simultaneously. They can be useful in reducing the number of MIDI events required to achieve particular effects, and can thereby reduce the delays sometimes associated with overloading MIDI. Some guitar controllers can transmit global controllers, and the VFX<sup>SD</sup> can respond to them.

In Mono mode (A or B) the base channel minus one becomes the MIDI channel for global controllers (pitch bend, pressure, etc.). For example, if the base channel is channel 3, any controllers received on channel 2 will be interpreted as global controllers and will affect *all* voices being played. If the base channel is channel 1, channel 16 becomes the channel for global controllers. Each track will also respond independently to controllers sent on its own channel. For example, each guitar string on a MIDI guitar can send independent pitch bend, while the "whammy bar" controller could be sent on the global channel to affect all voices.

- Press *MIDI Control* again. The display show the second sub-page:

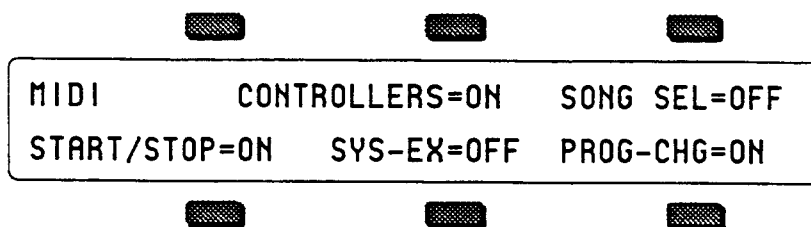

This page contains parameters which control how the VFX<sup>SD</sup> handles certain types of MIDI messages. The settings of the switches, like all other system parameters are retained while power is off.

### CONTROLLERS

This switch controls whether the VFX<sup>SD</sup> will send and receive MIDI controllers—pitch bend, mod wheel, pressure, volume, sustain pedal, etc.

### SONG-SEL

This determines whether the VFX<sup>SD</sup> will receive MIDI Song Select messages. When SONG-SEL=OFF, the VFX<sup>SD</sup> will ignore incoming Song Select messages. When SONG-SEL=ON, incoming Song Selects will select the corresponding VFX<sup>SD</sup> sequencer location.

MIDI Song Selects # 00-59 will select VFX<sup>SD</sup> Sequencer locations # 00-59. Conversely, selecting Sequencer locations # 00-59 will cause the VFX<sup>SD</sup> to send MIDI Song selects # 00-59.

### START/STOP

This parameter determines whether pressing the *Play* and *Stop/Cont* buttons will send MIDI Start, Stop and Continue messages from the VFX<sup>SD</sup> MIDI Out port. Some older drum machines have no way of disabling the receiving of these messages, and will always start playing their internal patterns when they receive a Start message. Set this parameter to OFF when you want to use such a drum machine simply as a voice module, played from a VFX<sup>SD</sup> sequencer track,



without starting its internal sequencer playing each time you press the *Play* button on the VFX<sup>SD</sup>.

- **ON** — When you press the *Play* or *Stop/Cont* buttons to start, stop or continue the VFX<sup>SD</sup> sequencer, a corresponding MIDI Start, Stop or Continue message will be sent.
- **OFF** — When you press the *Play* or *Stop/Cont* buttons to start, stop or continue the VFX<sup>SD</sup> sequencer, a MIDI Start, Stop or Continue message will *not* be sent.

## SYS-EX

This switch determines whether the VFX<sup>SD</sup> is able to receive MIDI System Exclusive messages. When SYS-EX=OFF, the VFX<sup>SD</sup> is not able to receive any MIDI System Exclusive messages. The Sys-Ex messages which are sent from the Storage Page can always be transmitted regardless of the setting of this switch. (Refer to Appendix A for more information about the Sys-Ex implementation).

## PROG CHG

This switch controls how the VFX<sup>SD</sup> handles MIDI program change messages.

- **OFF**—the VFX<sup>SD</sup> will *not* transmit or receive MIDI program changes
- **ON**—the VFX<sup>SD</sup> will transmit and receive program changes over MIDI.
- **NEW**—the VFX<sup>SD</sup> will transmit program changes only if they are *different* than the previous program change sent out on the particular channel. Program changes will be received normally.

Program changes are numbered and displayed from 001 to 128 in the VFX<sup>SD</sup>, although in accordance with the MIDI specification they are invisibly transmitted and received as 000...127.

(Refer the Performance MIDI parameters section and the Sequencer Basics section for more information on how program changes are handled).

## Receiving Program Changes

The way in which the VFX<sup>SD</sup> receives program changes is slightly more complex than some other systems because the number of programs and presets that are available to be selected from MIDI is *larger* than the number of program change messages available within the MIDI standard. To solve this problem, the VFX<sup>SD</sup> uses the last three program change numbers (126 to 128) to control how subsequent program changes will be interpreted. The following chart shows the effect of these three special program changes.

<i>After Program Change...</i>	<i>Subsequent program changes will select ...</i>	
126	001..060 - INT Programs	061..120 - CRT Programs
127	001..060 - ROM Programs	061..120 - CRT Programs
128	001..020 - INT Presets	021..040 - CRT Presets      041..060 - ROM Presets

These special "control" program changes need to be sent only once. All subsequent program changes will be handled according to the range that was set

by the last one received. If you press the *Presets*, *Sounds*, or *Cart* buttons on the front panel you may override the effect of the special program changes, and subsequent program changes will act in accordance with the mode the you have placed the VFX<sup>SD</sup> into with the buttons.

#### Selecting a new sequence or song effect from MIDI

There is another special program change, recognized only in MULTI mode, which is used to select *both* a program *and* its effect for one of the 12 sequencer tracks. When program change 125 is received on a channel assigned to a sequencer track, then the next program change received on that track will select a new program and also install the effect from that program into the sequence (or song) effect. This is the only way to change the sequence or song effect other than manually editing the settings, or selecting a new sequence. This can be useful when controlling the VFX<sup>SD</sup> from an external sequencer.

This special program change 125 does not change the way in which other program changes are received, including the other special messages. If the program you wish to select also requires a special control program change, then send the control message immediately after the 125, followed by the program number you want to select.

**Remember:** All VFX<sup>SD</sup> program changes are referred to and displayed as 001 to 128, but the actual codes transmitted and received over MIDI are less by one (000 to 127).

## Section 7 — Programming the VFX<sup>SD</sup>

What is a Program? . . . . .	7 - 1
Voices and Polyphony . . . . .	7 - 2
Patch Select Buttons . . . . .	7 - 2
Compare — Using the Compare Button/LED . . . . .	7 - 3
Edit Buffer . . . . .	7 - 3
Abandoning Your Edits . . . . .	7 - 3
Select Voice Page . . . . .	7 - 4
Group Edit Mode . . . . .	7 - 5
Programming the Patch Selects . . . . .	7 - 6
Program Control Page . . . . .	7 - 7
Write Page — Saving a New Program into Memory . . . . .	7 - 9

### What is a Program?

A VFX<sup>SD</sup> Program (or *sound* as we sometimes refer to it) is a dynamic structure made up of six *voices* and an *effect*. The status of the two Patch Select buttons determines which of those six voices will play at any given time. The diagram below illustrates the make-up of a VFX<sup>SD</sup> program.

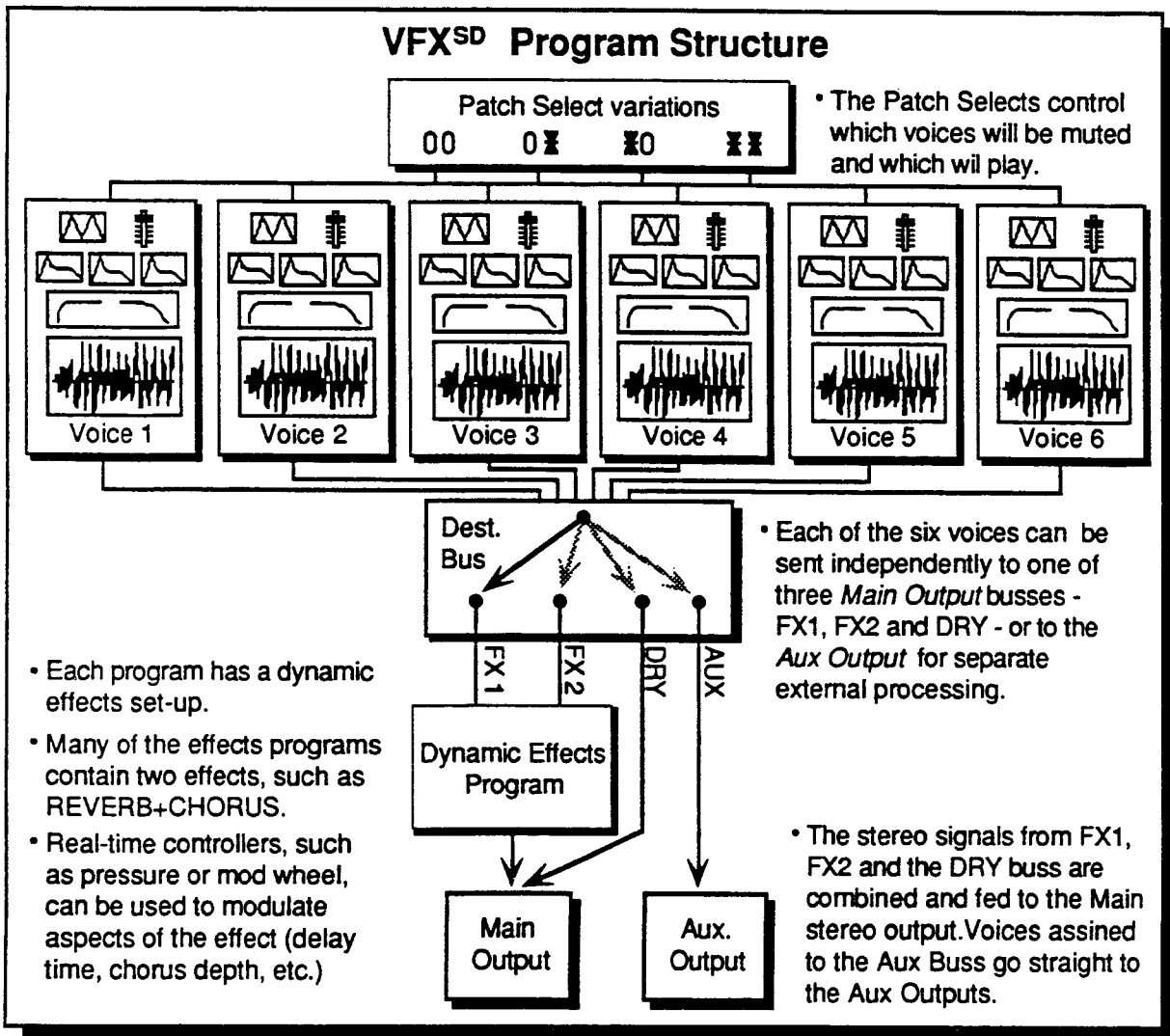

## Voices and Polyphony

When referring to the number of voices in a VFX<sup>SD</sup> program, we are *not* talking about polyphony (as in "you can only play so many notes"; see below). We are referring to the number of voices that will sound on each key as you play the program. The VFX<sup>SD</sup> is unique in that it lets you choose the number of voices (from one to six) per key for each program.

The VFX<sup>SD</sup> has a total of 21 voices which are dynamically assigned among the different sounds that you play. How many voices a sound uses on each key depends on the program. Many sounds use only one voice — in the case of these sounds you can play 21 notes before "voice stealing" occurs. On programs that use 2 voices, you can play 10 notes before any voices are stolen. Three voices, seven notes. And so on. Up to six voices can be active in one program.

Bear in mind that the VFX<sup>SD</sup> is "smart" about voice allocation — there are many things that a programmer can do to increase the apparent polyphony of a sound and to minimize the effects of voice stealing. For example:

- As soon as a voice is done playing (either because it reached the the end of the wave or because the volume envelope went to zero) that voice is returned to the pool, and a new note can use that voice rather than stealing one that is still sustaining. See "Voice triggering/Stealing notes," in Section 8.
- Also, you can assign low, medium or high priority to each voice in a program, which allows you to control how voices are reassigned. See "Output page" in Section 8.

## Patch Select Buttons

The two *Patch Select* buttons above and to the left of the pitch bend wheel provide instant access to four different variations within each program. When you press either or both of the Patch Select buttons you are selecting different combinations of the voices that make up a program. For each of the four possible patches, any combination of the six voices can be made to play or to remain silent.

The Patch Select buttons are "momentary" — an alternate patch will play only on notes played while the button is held down, unless you "lock in" a patch using the functions on the Patch Select page in the Performance section. (See Section 3.)

You can see the patches changing, and see which voices are playing for each patch, on the Select Voice page. Press *Select Voice*, then watch the display as you press the Patch Select buttons:

- The six voices that make up the program are represented on the display by the name of the wave that each is playing.
- Voices *without* brackets around the name are enabled for that patch and will play.
- Brackets around the name mean that the voice is muted for that patch and will not play.

The Patch Select buttons are sent and received over MIDI as MIDI controller #70. and will be recorded and played back by the sequencer like any other controller.

**Compare — Using the Compare Button/LED**

As soon as you change any parameter in a program, the LED in the *Compare* button will light. It will remain lit until you select another program or save (write) the newly edited program into memory. This is a constant reminder that something in the program has been changed.

To hear the original, unchanged program, press the *Compare* button. The *Compare* LED will go out, and you will hear the original sound and see the page with its original settings. Press *Compare* again to return to your edited program. You can toggle back and forth between the original and the edited sound as often as you like.

**Edit Buffer**

You can edit a program, while keeping the original program intact, because the edited version is kept in a special area of memory called the *Edit Buffer*. Whenever you change any parameter of a program, the altered program is put in the edit buffer, replacing whatever was previously there. Only one program at a time can reside there — the edit buffer always contains the results of your last edit.

When you press the *Compare* button, you are alternating between the program in the original memory location and the program in the edit buffer. We refer to the program in the edit buffer as the *Edit Program*.

You can return to the edit program, even after selecting another program (as long as you don't change any parameters there) by pressing the *Compare* button. This puts you back in the edit buffer, and any changes you make will affect the edit program.

The rule of thumb is this: Whichever program sound you hear, that's what you're editing.

If you like the results of the changes you have made to a program, you should rename it and save the new program permanently, to another location. The procedure for this is covered under "Write Page," later in this section.

**Abandoning Your Edits**

If you decide, while editing a program, that you're not happy with what you've done, and you want to start over with the original program, just go to the proper Program Select page and select the program again. Then you can start editing the program again from scratch. You will lose the one you were working on before.

## Select Voice Page

The Select Voice page is one of the central programming pages of the VFX<sup>SD</sup>. The mute status of each of the voices is shown on this page, and it is easy to see which voices are being heard and which are selected. Whenever you begin to edit a VFX<sup>SD</sup> sound, you should start here so that you know just which voice(s) you are editing.

On the Select Voice page you can:

- select a voice (or group of voices) for editing,
- determine which of the six voices will play (and which will be muted) for each of the four Patch Select variations, and
- temporarily solo any one of the voices without disturbing the other settings on the page.

Press *Select Voice*. The display looks something like this:

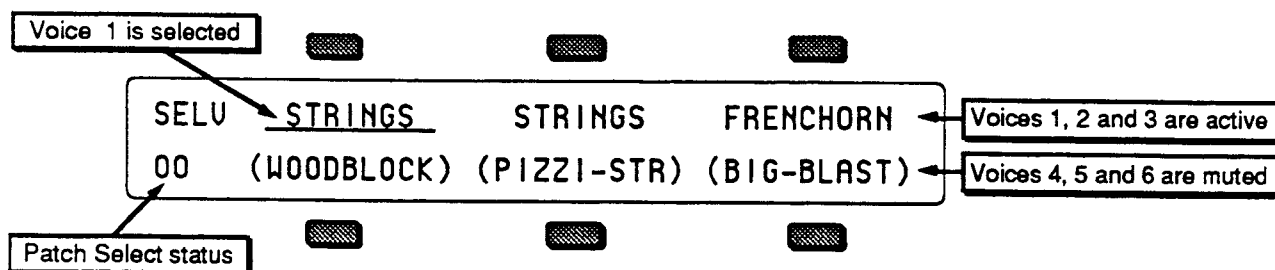

The six locations on the screen represent the six voices which are available within the program. For each voice the display shows the name of the wave that the voice is assigned to play, and the mute status of the voice in the current patch. When you press the soft button above or below one of these voices, it becomes underlined, indicating that it is the currently selected voice, the one that will be affected by any editing you do.

Voices shown without brackets are active and will play in the current patch. If you press the down arrow button while on a selected voice, it will mute that voice. Brackets (or parentheses) around the voice name indicate that the voice is muted in the current patch. Pressing the up arrow button on a muted voice will un-mute it.

Pressing the up arrow on an un-muted voice will solo that voice. Solo voices are displayed enclosed by asterisks, with all other voices muted. Pressing the down arrow on a soloed voice will return it and all other voices to their normal status.

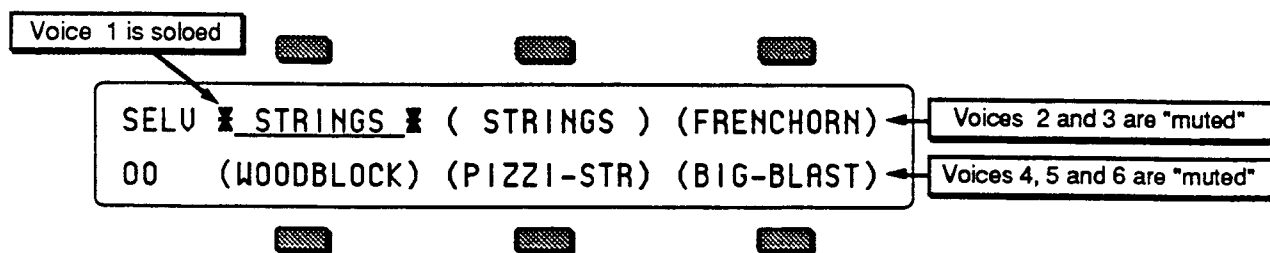

**Short Cuts (using the soft buttons)**

Once a voice is selected (underlined):

- If it is active, pressing its soft button again will mute it.
- If it is muted, pressing its soft button will un-mute it.
- Double-clicking will solo the voice. Click once more on a soloed voice to return all voices to normal.

Whenever you are on this page, pressing the *Select Voice* button again will return you to the page you were on prior to entering the Select Voice Page.

**Note:**

If you edit a voice which is muted, you will see the word MUTE flashing in the lower left corner of the display to remind you that you are *not* hearing the results of your edits.

**Group Edit Mode — Selecting More than One Voice at a Time**

Normally, when you are editing voice parameters, you are working on a single parameter within a single voice. In some cases you may want to edit the value(s) of the same parameter in more than one voice simultaneously. For example, you might want to edit the amplitude envelope release time for all active voices in a program at once, saving the time it would take to edit each of the voices individually. This may be accomplished using the special *group edit* feature of the VFX<sup>SD</sup>. Group editing is a temporary state that allows more than one voice to be "selected" on the Select Voice page, and any edits performed while in this group edit state will affect all of the voices which are not muted.

Ordinarily you can only select one voice at a time. However, if you want to edit the same parameter(s) for all the active voices simultaneously, double-click the *Select Voice* button. The Select Voice page will appear with all the active voices in the current patch selected. Now, parameter changes you make on any of the programming pages will affect all the voices currently playing.

Programming pages you select while in group edit mode will appear with "GRP" flashing in the lower left hand corner of the display to remind you that you are editing more than one voice.

Note that while in group edit mode, pressing any of the soft buttons on the Select Voice page will return it to its normal state, where only one voice can be selected at a time.

**Using the Group Edit feature**

- Make sure that the voices you wish to edit are not muted and then *double-click Select Voice*.
- The Select Voice page will be displayed with all voices included in the group to be edited appearing underlined.
- Perform the desired parameter edits. Using the data entry slider will set the value of all of the parameters being edited to the *absolute* value displayed for the current voice. Using the up/down arrow buttons will affect each parameter *relative* to its current value in each of the voices being edited.
- Changing the mute status of any voice, or selecting a new voice or program, will disable the group edit feature and return the VFX<sup>SD</sup> to its normal state.

Note that the parameter values displayed when editing in Group Edit mode are the values for the voice which was selected before you entered Group Edit mode *unless* the previously selected voice was muted and was not included in the

group. In this case you will see the values for the first voice in the group.

This feature can be particularly convenient when editing programs with multiple-voice components that you wish to edit simultaneously. Set up a patch select for each of the various sets of voices that you wish to edit together, muting all voices except the set you wish to group. When you wish to edit a particular set, simply set the patch select and then double click *Select Voice* to enter group edit.

**Note:** The mute status of the patch select which is selected at the time when you double-click *Select Voice* will determine which voices are included in the group. It is possible to have muted voices appear in the group if you enter group edit mode from a patch select in which those voices are *not* muted.

### Programming the Patch Selects

There can be four variations of the program, one for each of the four possible Patch Select button positions. The patch selects are used to control which voices in a program are active or muted. The current patch select variation is shown in the lower-left corner of the display on the Select Voice page. For either button, a "0" indicates that the button is not being pressed, and an asterisk (or star \*) indicates that the button is down.

While on the Select Voice Page, press the Patch Select buttons and watch as the display changes to show the status of each patch variation. Note that for each of the four patch select variations, a different combination of voices can be active or muted. This enables the programmer to set up the patches to add or subtract components of the sound dynamically. The variations can range from subtle alterations to dramatic changes in the characteristics of the sound that the program produces.

The Performance Patch Select parameter controls how the patch selects will operate. If the parameter is set to LIVE, then pressing the Patch Select buttons while the Select Voice page is displayed will show the different variations. One of the four patch select variations may be "latched-in" as the current default by changing the value of the Performance Patch Select parameter for the currently selected program. Refer to the Performance Parameter section for more information on controlling the Patch Selects.

**Programming Tip:** When programming the patch selects, it is often convenient to be able to instantly latch different Patch Select variations so that you can set up the voice mutes for each variation. You can do this by setting the Performance Patch Select parameter to HOLD. Refer to the Performance Parameters section for more information.



## Program Control Page

The parameters on this page control aspects of the program that affect *all* of the individual voices within the program.

Press *Program Control*. The display shows:

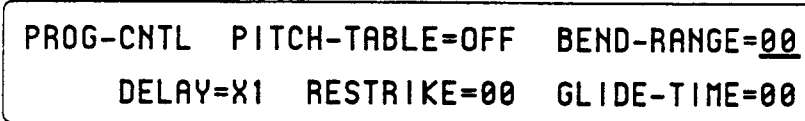

```

PROG-CNTL  PITCH-TABLE=OFF  BEND-RANGE=00
          DELAY=X1  RESTRIKE=00  GLIDE-TIME=00
  
```

### PITCH-TABLE

The setting of this switch indicates whether a Custom Pitch-Table exists within the program. Custom pitch-tables occupy the portion of a program which is usually used by voices 5 and 6, so when a pitch-table is present, you do not have access to those two voices. Whenever the setting of this switch is changed, you will be prompted with questions that ask you to verify the action that will be taken. If you answer **NO** to the prompt, then the setting of the switch is *not* changed. Refer to the Using Pitch Tables section for more information about pitch-tables.

- **OFF** — there is no custom pitch-table in this particular Program.
- **ON** — a custom pitch-table does exist in the program and voices 5 and 6 have been replaced by the custom pitch-table.

### BEND-RANGE

The setting of this parameter determines whether the program has its own independent pitch bend-range, or whether it will use the system bend range to determine the maximum pitch change which can be applied by the the pitch wheel. The bend-range set on this page will override the system bend range for this program only. See the description of the Bend Range parameter on the Master Page in the System Control section for more information on the system bend-range.

Range: 00 to 12 and \*\*. If BEND-RANGE =\*\* then the program will use the system bend range selected on the Master page.

### DELAY

Delay is a multiplier which affects all of the individual delay times which appear on the Wave page for each of the voices. The multiplier affects both the maximum delay time available and the timing resolution of the delay. This parameter is program-wide and affects *all* voices in the program. Refer to the description of the Wave page in the Voice Programming section for more information on the voice delay feature.

Range: X1, X2, X4, X8

## RESTRIKE

This parameter controls the Restrike time. When you play a particular note and then restrike it again immediately before the old note has finished sounding, the amount of time it takes for the first strike to fade away is determined by this parameter. By varying the setting of this parameter, you can control how long sounds overlap when a note is restruck.

For example, if you have a slow string sound, it may sound more natural to use a longer restrike value, which will cause the old note to decay more slowly, rather than end abruptly when the new note starts. Normal values are around 10. The higher the value, the longer the fadeout time.

Range: 00 to 99

Note: If you hear clicking sounds when you restrike a note, setting the Restrike time to higher values may eliminate the click.

## GLIDE-TIME

This parameter controls the time it takes for the pitch to slide smoothly (glide) from one note to another. All six voices in a Program use the same Glide-Time. However, on the Pitch Mod page of each individual voice is a parameter that controls whether the voice will glide or not.

Range: 00 to 99 (the higher the value, the longer the Glide-Time)

## Write Page — Saving a New Program Into Memory

Once you have modified an existing program, or created an entirely new one, you can *write*, or save, that program to any internal or cartridge memory location using the Write Page. This page is also used to rename the program with the name of your choice.

When you are ready to save a program into memory, first decide on a name of up to eleven letters for your new program. Then:

- Press *Write*. The Write page appears as shown below, with the current program name showing. You will see a cursor, or underline, beneath the first letter of that name.

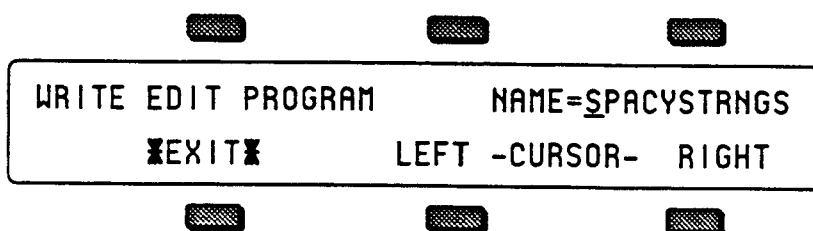

- Edit the Program Name using the data entry slider and the two Move Cursor soft buttons, labeled LEFT and RIGHT. You can move the data entry slider up and down to scroll through the available characters, or step through them one at a time with the up and down arrow buttons. Find the first letter you want, then press the RIGHT button to move the Cursor to the next location. Repeat this procedure until the display shows the name you have chosen. (Or if the KEYBOARD -NAMING parameter on the Master page is ON, you can use the keyboard to enter the name — see Section 6)

### Hint:

Moving the data entry slider all the way down gives you a blank space. Also, using dashes, periods and slashes between characters can make a sound name hold together better when displayed on Program Bank and Preset pages.

- Select a memory location for your new program. Press one of the Bank buttons, 0-9. As long as you hold the button down, the display will show the program select page for that bank, with two differences: 1) None of the program names are underlined, and 2) the word "SAVE" is flashing in the lower left-hand corner, below the page name.

When you release the Bank button, the display will return to the Write page. Press another Bank button and the display shows you the programs for that bank. To look at the Programs in the cartridge, simply press *Cart*, and then press and hold down any of the ten Bank buttons, as before. You can also press the bank buttons while holding down the *Sounds* button to "shop around" without returning to the Write page each time you release the bank button.

- You may want to audition a few sounds before deciding which to replace. In this case, press the button beneath the word \*EXIT\* on the display. This takes you off the Write Page. Now use the Bank buttons and the program select pages in the usual way to select and listen to the Programs in memory. Your new Program is still safe in the VFX<sup>SD</sup>'s edit buffer.

**Warning:** While you're doing this, DO NOT use the data entry controls to change any parameters in the programs you audition, as this would instantly replace your hard-earned new Program in the Edit Buffer with something else entirely.

When you are through listening, return to the program you want to save by pressing the *Compare* Button. The *Compare* LED will light. Now press the *Write* to return to the Write Page. Your new program and its new name should be just where you left them.

- To save the program, press the appropriate Bank button, and *while holding it down*, press the soft button which corresponds to the program you wish to write over. This writes the new program, with its new name, into that memory location.

The display shows the message WRITING PROGRAM - PLEASE WAIT, which will remain for about a second. The VFX<sup>SD</sup> will then return to the bank into which the new program has just been saved. The new program is underlined, and is thus selected as the current program.

#### **\*EXIT\***

The Button beneath the word \*EXIT\* can be pressed at any time to exit the WRITE Page and return to the Page you were on before entering it.

#### **Copying an Existing Program to Another Location**

Sometimes you'll want to take an existing program, one that you haven't been editing, and simply copy it to another memory location. For example, you might want to put the six most commonly used programs in the same bank, for easy access during performance.

To do this you will use the VFX<sup>SD</sup> Copy function. Normally the Write page "looks" only at the edit buffer, but you can use the Copy function to place an existing program onto the Write page:

- Select the sound you want to copy.
- Press *Copy*. The *Copy Context* on the top line of the display shows PROGRAM PARAMETERS.
- Press MAKE COPY. This puts the current program into the copy buffer.
- Press RECALL. This puts you back on the Write page, with the new program showing. Now proceed exactly as described above to write the program to the new location.

## Section 8 — Voice Programming

This section covers those functions which can be edited independently for each individual voice within the program.

VFX <sup>SD</sup> Voice configuration . . . . .	8 - 1
Modulators . . . . .	8 - 3
About Modulation . . . . .	8 - 3
Selecting a Modulator . . . . .	8 - 3
Modulation Amount . . . . .	8 - 3
Modulation Sources . . . . .	8 - 4
Wave Page . . . . .	8 - 8
Wave Class . . . . .	8 - 8
Wave List . . . . .	8 - 9
General Wave Parameters (All Wave Classes) . . . . .	8 - 10
Type-Specific Wave Parameters . . . . .	8 - 11
VFX <sup>SD</sup> Drum Sounds . . . . .	8 - 14
Pitch Page . . . . .	8 - 16
Pitch Mod Page . . . . .	8 - 17
Filters Page . . . . .	8 - 19
Filter Configurations . . . . .	8 - 21
Output Page . . . . .	8 - 23
LFO Page . . . . .	8 - 27
ENV 1, ENV 2, ENV 3 — VFX <sup>SD</sup> Envelopes . . . . .	8 - 30
Mod Mixer Page . . . . .	8 - 36

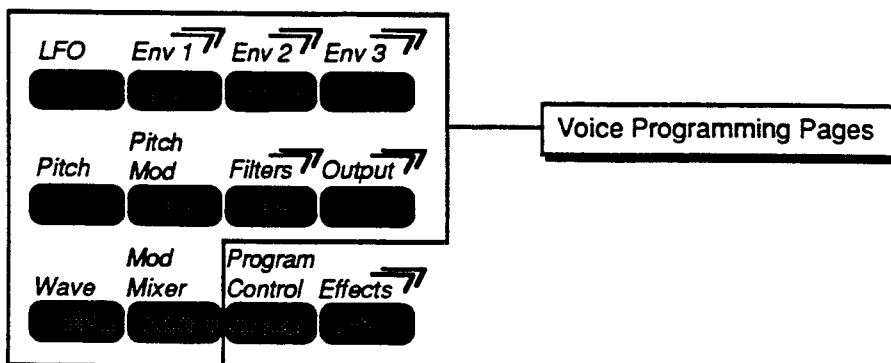

### VFX<sup>SD</sup> Voice configuration

Each of the six voices within a VFX<sup>SD</sup> program consists of:

- a digital oscillator playing one of the 141 waves from the VFX<sup>SD</sup> wave memory
- two multi-mode digital filters
- one LFO (Low Frequency Oscillator)
- three complex envelope generators for controlling volume, pitch, filter frequency, etc.
- a versatile matrix modulation scheme with 15 routable modulation sources

The diagram on the following page shows the configuration of one VFX<sup>SD</sup> voice.

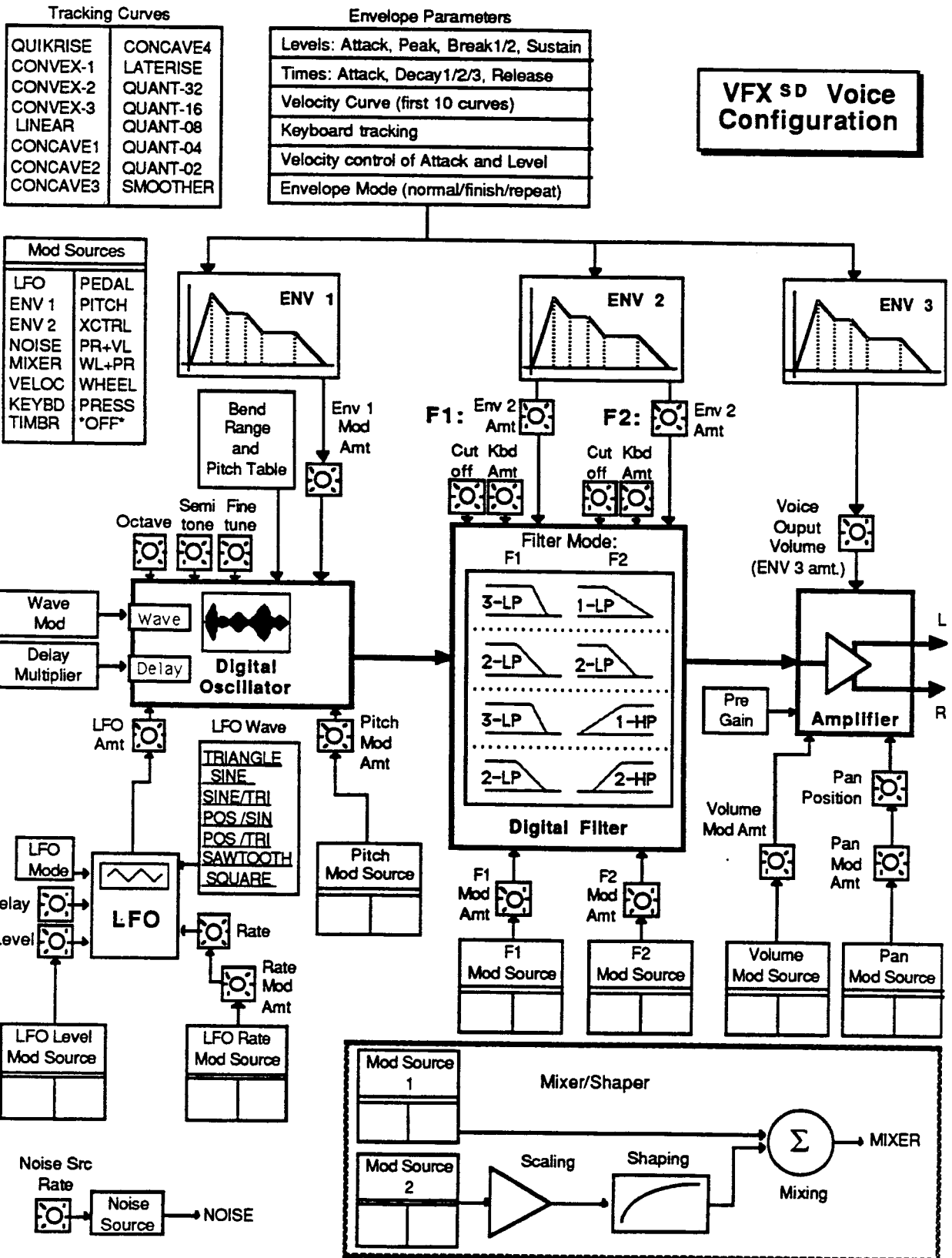

## Modulators

### About Modulation

To modulate something is simply to cause it to change. Within the voice architecture of the VFX<sup>SD</sup> we begin by setting basic, or manual, levels for the volume, pitch, brightness, etc. of a voice, and we then modulate those levels in various ways in order to create movement and dynamics.

Suppose you switch on your stereo, and turn the volume half way up. We can call this the manual volume setting. It will stay at that level until it's changed. Now suppose that you take the volume knob of your stereo and begin quickly turning it up and down, so the volume gets continuously louder and softer, louder and softer. What you would be doing is modulating the volume of your stereo. If you were to take the treble control, and do the same to that knob, you would be modulating the brightness of your stereo.

In much the same way we modulate various levels within the VFX<sup>SD</sup> (though generally the approach is less haphazard). There are 15 different *Modulation Sources* available, and they can each be independently assigned to vary the manual levels for a great many aspects of a voice, including real time control of some aspects of an effects program.

### Selecting a Modulator

On those programming pages where a modulator can be selected to vary the level of some function within a VFX<sup>SD</sup> voice, the display shows MODSRC=\_\_\_\_\_ (short for Modulation Source). A modulator is selected by selecting (underlining) that parameter with the appropriate soft button, and then using the data entry slider or the up/down arrow buttons to select among the 15 available modulation sources.

### Hint:

Moving the data entry slider all the way up selects \*OFF\*, which is handy if you don't want a Modulator applied in a particular location.

Let's take, for example, the *Pitch Mod* page, which is where you apply modulation to the pitch of a voice. Press *Pitch Mod*. In addition to Envelope 1 and the LFO, which are always available, you can choose an additional modulator to alter the pitch:

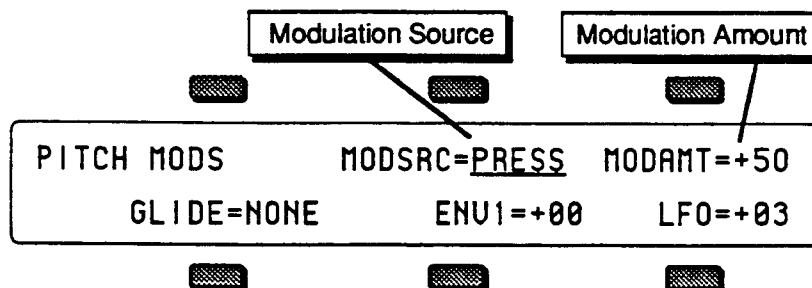

### Modulation Amount

As shown above, where a modulation source is selected, the parameter immediately to its right controls the *Modulation Amount* (the display shows MODAMT=±##) which controls how deeply the selected modulator will affect the level to which it is being applied.

Press the soft button above MODAMT=, and use the data entry controls to adjust the modulation amount. Modulation amount can be positive or negative. A modulation amount of +00 has the same effect as turning the modulator \*OFF\*.

**Hint:** With modulation amount, as with all parameter values that have a center value (in this case, +00), there is an easy way to reach that value. With the MODAMT selected, press the down arrow button, and *while holding it down*, press the up arrow button, then quickly release both buttons. This automatically sets the modulation amount to +00.

### Modulation Sources

The 15 Modulation Sources available on the VFX<sup>SD</sup> are as follows:

- LFO — Low Frequency Oscillator
- ENV 1 — Envelope 1
- ENV 2 — Envelope 2
- MIXER — Mod Mixer/Shaper
- NOISE — Noise Generator
- VELOC — Velocity
- KEYBD — Keyboard Tracking
- TIMBR — Timbre Control
- PEDAL — Voltage Control Foot Pedal
- PITCH — Pitch Bend Wheel
- XCTRL — External Controller (MIDI)
- PR + VL — Pressure + Velocity
- WL + PR — Wheel + Pressure
- WHEEL — Modulation Wheel
- PRESS — Pressure (After-touch)

#### • LFO — Low Frequency Oscillator

The *Low Frequency Oscillator* generates only very low frequency waves, below the audio spectrum, which can produce vibrato, tremolo, and many other effects, depending on the LFO wave selected, and where it is applied as a modulator. There are seven possible waveshapes for the LFO. See LFO Page later in this section for a complete discussion of the LFO.

#### • ENV 1, ENV 2, (ENV 3)

The VFX<sup>SD</sup> has three complex *Envelopes*. Envelopes are used to create changes, over time, in pitch, brightness, volume, etc.

- ENV 1 is permanently routed to the pitch of the voice, though it can be assigned as modulator elsewhere if you wish.
- ENV 2 is permanently routed to the filter cutoff frequency. It also can be assigned as a modulator elsewhere.
- ENV 3 is a special case. ENV 3 *always* controls the volume of the voice, and cannot be selected as a modulator anywhere else.

A discussion of the VFX<sup>SD</sup> Envelopes follows later in this section.

#### • NOISE — Noise Generator

The Noise generator creates a randomly changing level. It is useful for modulating, among other things, the pitch of a voice (Pitch Mod page). Applied to pitch with large modulation amounts it tends to create strange "computer sound" effects. Small modulation amounts (around +02 to +04) can create a subtle random movement in the sound, which can impart a more natural quality.

On the second sub-page of the LFO page (press *LFO* twice) there is a parameter labeled NOISE SOURCE RATE=##, which adjusts the rate at which the level of this modulator will change.



- **MIXER — Mod Mixer/Shaper**

The Mod Mixer/Shaper is a powerful feature of the VFX<sup>SD</sup> voice architecture which allows you to assign two modulation sources to one input, and to scale and shape the response of one of those modulators in a number of ways. The controls on the Mod Mixer page are used to determine what will happen when MIXER is chosen as a modulator. See Mod Mixer page in the Programming section for a full discussion of the Mod Mixer/Shaper.

- **VELOC — Velocity**

Velocity means how hard you strike a key. Selecting VELOC as a Modulator allows you to modulate any manual level with velocity. Velocity as a modulation source only goes positive (though assigning a negative modulation amount will make the net result be to reduce the level with increased velocity).

- **KEYBD — Keyboard Tracking**

This uses the position of a note on the keyboard as a modulator. The scaling effect of this Modulator is figured over the full 128 MIDI key numbers:

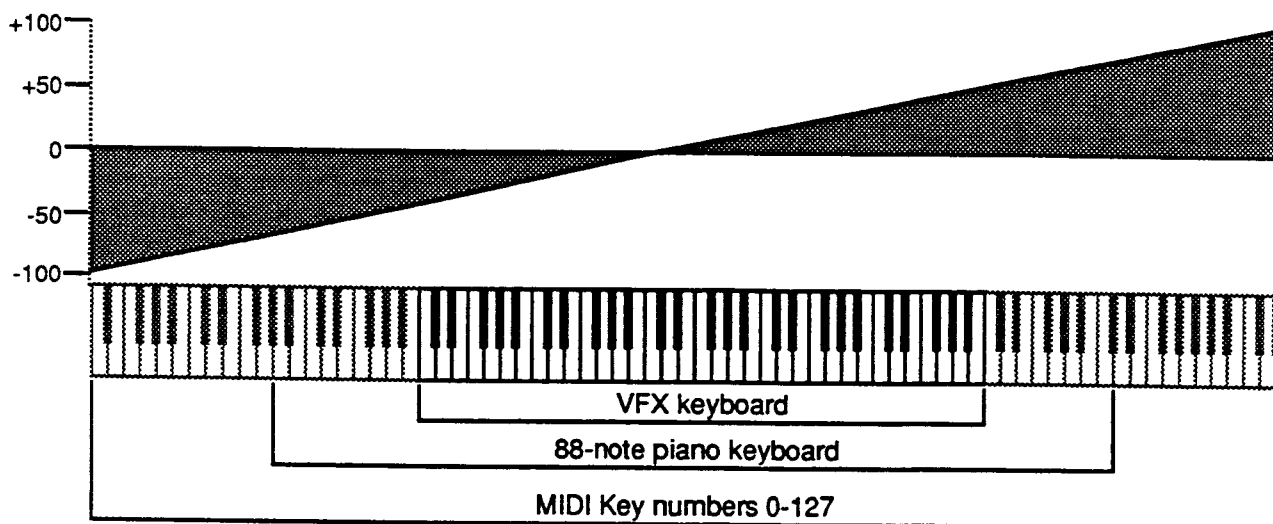

As the above illustration shows, the effect of KEYBD as a modulator goes negative as well as positive. The effect of KEYBD is to reduce the Level on notes below the break point (Middle C), and increase levels above that point. Negative Modulation depths will do the opposite.

- **TIMBR — Timbre Control**

This is a special modulator, unique to the VFX<sup>SD</sup>, which is intended as an "extra" real-time performance controller. TIMBR can be assigned like any other modulator wherever a modulation source is selected. It is controlled from the Timbre page in the Performance section of the front panel. Whenever you are playing a sound or preset, you can press *Timbre* and use the data entry slider to change the level of this modulator.

Note that because it can be assigned to modulate anything within a voice, the Timbre control will not always necessarily adjust the tone color (which is what we normally associate with the word *timbre*) of a given sound, depending on what the programmer has chosen to do with it. As a rule, however, programmers are encouraged to make sure that Timbre always does *something* interesting to the sound.

- **PEDAL — Voltage Control Foot Pedal**

This selects the *CVP-1 Foot Pedal*, which can be plugged into the Pedal•CV jack on the VFX<sup>SD</sup> rear panel, as a modulator. Its effect will be the same as that of the mod wheel. It can be applied wherever a Modulator is selected.

Note that the Foot Pedal will only act as a modulator when the Pedal Function Select parameter is set to PEDAL=MOD on the Master Page. When that parameter is set to PEDAL=VOL the Foot Pedal will act as a volume pedal, not as a modulator (though this has no effect on incoming MIDI Foot Pedal data). See the section Master Page for more details.

- **PITCH — Pitch Bend Wheel**

This assigns the Pitch Wheel, located to the left of the mod wheel, as a modulator. It allows you to have the Pitch wheel, in addition to bending the pitch of a note (its normal function), also affect some other level. Applied to the filter cutoff frequency, for example, this would cause notes to become brighter as you bend them upwards and more muted as you bend them down (or the opposite with negative modulation amounts).

- **XCTRL — External Controller (MIDI only)**

An external controller such as a Breath Controller, Data Entry Slider, etc., which is received via MIDI from another synthesizer or controller, can be assigned as a modulator within your VFX<sup>SD</sup> Programs. On the MIDI Control Page, you select the number of the external controller that will be recognized by the VFX<sup>SD</sup>.

You don't have to be playing the VFX<sup>SD</sup> from an external instrument for this to work. For example, if you have a keyboard with a Breath Controller; 1) Connect its MIDI Out to the VFX<sup>SD</sup> MIDI In; 2) Make sure both instruments have controllers enabled (MIDI Control page); 3) Select Breath Controller as the external controller that will be received by the VFX<sup>SD</sup> (XCTRL=02, also on the MIDI Page); 4) assign XCTRL as a Modulator for LFO level, Filter Cutoff frequency, or some other manual level within a voice, as shown in the Programming section; and 5) play the sound from the VFX<sup>SD</sup> keyboard, while blowing into the Breath Controller connected to the sending instrument. The modulation will have the same effect as if you were playing from the sending instrument.

- **PR + VL — Pressure + Velocity**

This is one of two "combination" modulators. When this modulator is selected, either pressure *or* velocity will affect the level which is being modulated.

- **WL + PR — Wheel + Pressure**

Another combination modulator. When selected, either the mod wheel *or* pressure will affect the level which is being modulated. This can be good for modulating LFO depth when using the LFO for vibrato. That way the player can use either to get vibrato.

- **WHEEL — Modulation Wheel**

The *Mod Wheel* to the left of the keyboard is assignable wherever a modulator is selected. To use the mod wheel for vibrato (one common application) WHEEL must be assigned to modulate the LFO, and the LFO Amount set to some number other than zero on the Pitch Mod Page. The mod wheel's effect is positive-going only, from 0 (wheel towards you) to +99 (wheel away from you). Negative modulation amounts will reverse the effect.

- **PRESS — Pressure (After-touch)**

Pressure, also called after-touch, is a modulator which varies a manual level within a voice depending on how hard you press down on a key or keys. After you have struck a key, and while the note is sustaining, continuing to press down harder on the key brings in pressure. The VFX<sup>SD</sup> keyboard generates pressure, and by using this modulator you can add a tremendous amount of expression to your sounds without ever taking your hands off the keyboard.

Pressure comes in two varieties — *Poly-Key™* pressure (or Polyphonic pressure), which affects each note individually, and *Channel* pressure (or Mono pressure) which affects all notes that are playing when you exert pressure on any key. Either type of pressure is available on the VFX<sup>SD</sup>, and both types are received via MIDI.

There is a Performance parameter on a sub-page of the Patch Select Page (press *Patch Select* twice) which determines which of the two types of pressure will be used by the program. This control can also be set to NONE, in which case the program will not respond to pressure internally, nor will it send or receive it via MIDI. (See Performance Parameters for more details.)

Note that not all sounds are necessarily programmed to respond to pressure. If pressure seems to have no effect when you play certain sounds, it is likely that the programmer did not assign pressure as a modulator anywhere within the program.

The effect of pressure as a modulator is positive-going only, though assigning a negative modulation depth will cause increased pressure to reduce manual levels.

## Wave Page

Each VFX<sup>SD</sup> voice will play one of the 141 Waves in its memory. These waves are the "raw material" from which VFX<sup>SD</sup> programs are crafted. On the Wave Page you can choose which wave the currently selected voice will play, and modify the various playback parameters of the wave.

## Wave Class

The VFX<sup>SD</sup> waves are divided into 12 categories, or *Wave Classes*:

The first six classes, along with the final two, contain samples of real acoustic and electronic sounds, which can be used as the basis for a wide variety of realistic musical sounds. Where necessary, these waves have been *multisampled* (sampled at many points through the range of the instrument) for maximum faithfulness to the original.

- **STRING-SOUND** - Samples of stringed instruments — strings, pianos, guitars, etc.
- **BRASS-SOUND** - Samples of brass instruments — horns, sax, etc.
- **BASS-SOUND** - A variety of bass sounds — electric, acoustic and synthesized.
- **BREATH-SOUND** - Flute and vocal sounds with complex, breathy sustains.
- **TUNED-PERCUS** - This category contains a wide variety of sounds — generally, these are percussive sounds which are looped (that is, they will sustain).
- **PERCUSSION** - This class contains unlooped (non-sustaining) percussion sounds and drum sounds which the VFX<sup>SD</sup> shares with the VFX.
- **DRUM-SOUND** - Individual drum and percussion sounds which are unique to the VFX<sup>SD</sup>; that is, not found on the VFX.
- **MULTI-DRUM** - Also unique to the VFX<sup>SD</sup>, these are multisampled waves consisting of various combinations of the individual drum sounds, arranged in such a way that you can easily combine them to form your own custom kits.

The next three wave classes contain a variety of sampled and algorithmically generated waves that are more "synthesizer" oriented:

- **TRANSWAVE** - Transwave is a special class of waves, unique to the VFX and VFX<sup>SD</sup>. Each Transwave consists of many single-cycle waveforms, each with a different harmonic spectrum. The playback parameters allow you to start the wave playing at any one of these waveforms and move through the wavetable, continually varying the timbre of the sound, using any of the 15 modulators.
- **WAVEFORM** - A waveform is a single cycle of a sound repeated over and over. The VFX<sup>SD</sup> contains both sampled and synthetic waveforms. Waveforms such as Sawtooth and Square can be used to reproduce a wide array of analog synth sounds.
- **INHARMONIC** - Inharmonic loops are similar to waveforms except that they contain many cycles of the sound and can therefore contain *inharmonics* — frequencies which are not exact multiples of the fundamental frequency.

The wave class **MULTI-WAVE** contains only one wave, but it consists of **ALL-WAVES** in the VFX<sup>SD</sup> memory, except for the **DRUM-SOUND** and **MULTI-DRUM** waves. Starting from any wave in memory, any number of waves can be played, forward or backward, to create effects and "jam-loops."

Wave List

Below is a complete listing of the 141 VFX<sup>SD</sup> Waves. The wave class is shown in bold at the top of each group.

<p><b>STRING-SOUND:</b>            STRINGS            PIZZI-STR            GRAND-PNO            PIANO.VAR            DIGIPIANO            CLAVPIANO            ACOUS-GTR            GUIT.VAR1            GUIT.VAR2            GTR-HARMO            EL-GUITAR            PLUCK-GTR            CHUKKA-GT            CRUNCH-GT            CRUNCH-LP</p>	<p><b>BRASS-SOUND:</b>            UNI-BRASS            TRUMPET            TRUMP.VAR            FRENCHORN            FHORN.VAR            SAXOPHONE            SAX.VAR-1            SAX.VAR-2</p>	<p><b>TUNED-PERCUS:</b>            MARIMBA            KALIMBA            STEELDRUM            DOORBELL            POTLID-HT            SYN-PLUCK            PLINKHORN            FLUTEDRUM            PNO-PING            ORCH-HIT            KAGONG            RACK-BELL            CRASH-CYM</p>	<p><b>PERCUSSION:</b>            WOODY-HIT            WOODBLOCK            TEMPL-BLK            DINKY-HIT            TOYHAMMER            AGOGO-BEL            SLINKYPOP            DUCT-TAPE            STEAMDRUM            BIG-BLAST            SPRAY-CAN            METALDINK            VOCALPERC            ANVIL-HIT            KICK-DRUM            SNAREDRUM</p>
<p><b>TRANSWAVE:</b>            SPECTRAL-X            DIGITAL-X            VOCAL-X            DOCTOR-X            INHARM-X            SYNCHRO-X            OMEGA-X            ESQBELL-X            FORMANT-X            PLANET-X            ELECTRO-X            PULSE.1-X            PULSE.2-X            RESONANT1            RESONANT2            RESONANT3            RESONANT4</p>	<p><b>BREATH-SOUND:</b>            WOODFLUTE            CHIFFLUTE            OCARINA            VOX-OOOHS            VOCAL-PAD</p>	<p><b>DRUM-SOUND*:</b>            GATE-KICK            ROOM-KICK            GATE-SNARE            RIM-SNARE            CLOSE-HAT            OPEN-HAT            RIDE-CYMB            DRY-TOM-L            DRY-TOM-H            GAT-TOM-L            GAT-TOM-            RM-TOM-L            RM-TOM-H            TIMBALE            CONGA-LO            CONGA-HI            TAMBORINE</p>	<p><b>MULTI-DRUM*:</b>            ALL-PERC            ALL-DRUMS            KICK-DRMS            SNAR-DRMS            HI-HATS            CYMBALS            TOM-TOMS            PERCUSSON            DRY-TOMS            ROOM-TOMS            GATE-TOMS            CONGAS            STD-KIT            GATED-KIT            ROOM-KIT</p>
<p><b>MULTI-WAVE:</b>            ALL-WAVES</p>	<p><b>WAVEFORM:</b>            ORGAN-V.1            ORGAN-V.2            ORGAN-V.3            ORGAN-V.4            SAWTOOTH            SQUARE            SINE-WAVE            TRIANGLE            1+2 HARMS            2HARM-SAW            FRETLESS            DPNO-TINE            BUBBAWAVE            CLAV-WAVE            CLAV.VAR            WOODWIND</p>	<p>WWIND.VAR            PIPE-ORGN            BRASS-ORG            VOCAL-BEL            SYNTH-BEL            DIGI-VOX            CLARINET</p>	<p><b>INHARMONIC</b>            TRIANG-LP            ANVIL-LP            CLUSTR-LP            TUBULAR-L            NOISE-LP</p>

- The bold lines in the above illustration separate wave classes which have different type-specific (lower-line) wave parameters. See "Type-specific Wave Parameters" later in this section.
- The suffix ".VAR" after a wave name indicates a "timbre-shifted" version of one of the other waves; that is, it has different split points between the multisamples in order to create a different frequency spectrum.
- \* The DRUM-SOUND and MULTI-DRUM waves *not* contained in the VFX.

## General Wave Parameters (All Wave Classes)

Press *Wave*. On the Wave page, the same three parameters (Wave Name, Wave Type, and Delay) will always appear on the top line of the display, no matter which type of wave is selected.

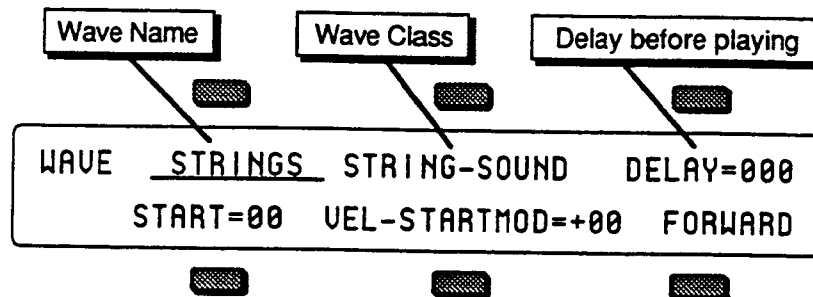

### WAVE NAME

Here you select the actual wave which the voice will play. When this parameter is underlined, the data entry slider will select only among the waves in the current wave class. Pressing the up and down arrow buttons will allow you to cross over into the next category.

### WAVE CLASS

This shows which of the 12 groups (listed earlier) the currently selected wave is in. By underlining this parameter, you can use the the data entry slider or the up and down arrow buttons to scroll quickly through the different the wave classes to the category you want. Then underline the wave name to select a specific wave from that category.

Whenever the wave class is changed, the first wave in that class is selected, and lower-line parameters are reset to default values for the new wave class.

### DELAY

The Delay determines how long the voice will wait after a key is struck before playing. Adjustable from 000 to 250. A delay of up to 2 seconds is possible.

The size of the steps and the total range of this control, in terms of actual delay time, depend on the value of the *Delay Multiplier* parameter on the Program Control page (DELAY=XX). The size of the increment represents 1 millisecond (1/1000 second) of delay, times the multiplier on the Program Control page:

When:

- DELAY=X1, this parameter goes from 0 to 250ms (1/4 second) in 1ms steps.
- DELAY=X2, this parameter goes from 0 to 500ms (1/2 second) in 2ms steps.
- DELAY=X4, this parameter goes from 0 to 1 second in 4ms steps.
- DELAY=X8, this parameter goes from 0 to 2 seconds in 8ms steps.

While the delay can be set independently for each voice, the Delay Multiplier parameter is the same for all the voices in the program. This means that the delay setting for all voices will be multiplied by the same factor.

**Triggering a voice with a Key up** — In the highest position, DELAY=KUP (KeyUP), the voice will wait until the key is released before it plays.

**Type-specific Wave Parameters**

The parameters shown on the lower line of the display on the Wave page will vary depending on the current wave class. For each wave class, the lower line of the display will contain parameters controlling the features which are specific to that category.

As mentioned earlier, changing the wave class resets these parameters. However, if you scroll only one step away from the current class and then scroll back, any lower-line settings you had will be restored. Go more than one class from the current one and any lower-line settings will be lost.

STRING-SOUND  
BRASS-SOUND  
BASS-SOUND  
BREATH-SOUND  
TUNED-PERCUS  
PERCUSSION  
DRUM-SOUND &  
MULTI-DRUM Parameters

For these eight categories of waves, the bottom line of the display shows:

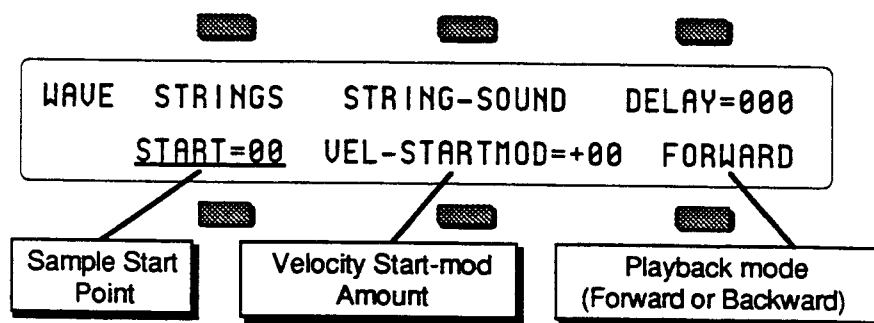
**START**

**Start Point** - This controls where in the sample the wave will begin playing. When **START=00**, the whole wave will play. As the start point is adjusted upwards it will begin playing further into the wave. You can use this, for example, to skip the attack and play only the loop portion of looped (sustaining) sounds. Range = 00 to 99

**VEL-STARTMOD**

**Velocity Start-mod Amount** - This parameter lets the velocity with which you strike the key move the sample start forward or backward for each note you play. Positive values will move the start point forward (toward the end of the sample) with greater velocity; negative values will move the start point back toward the beginning as velocity increases. Note that if **START=00**, negative values of this parameter will have no effect. Range = -99 to +99

**FORWARD/REVERSE**

**Playback Mode** - Any of the waves in these eight categories can be made to play forward (which is the normal mode) or backward with this parameter. When the playback mode is **REVERSE**, the sound will play from the end of the sample to the start point (wherever that has been set to).

**TRANS-WAVE Parameters**

Each Trans-wave is actually composed of many different single-cycle waveforms, which progress from one timbre to another, occupying adjacent areas of memory. Movement within the sound is created by playing different waveforms in succession; that is, by modulating the wavetable.

The illustration below shows a typical wave of this category, with the start point set in the middle range, near 50.

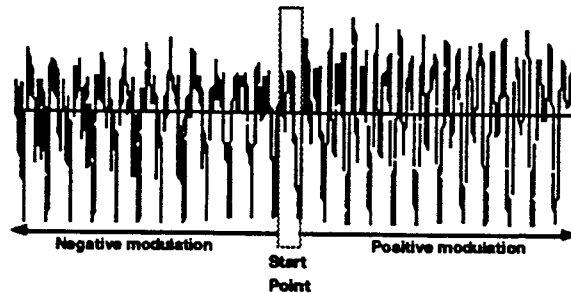

When the wave type is TRANS-WAVE, the lower line of the display shows:

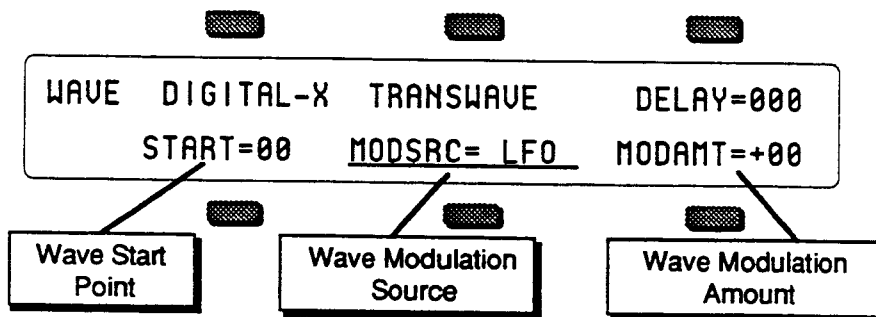
**START**

**Start Point** - The Start Point parameter controls where within the wave the voice will begin playing when the key is struck.  
Range = 00 to 99

**MODSRC**

**Modulation Source** - Here you choose which of the 15 modulators will control the movement of the sound. Any of the modulators can be selected.

**MODAMT**

**Modulation Amount** - Determines how much the selected modulator (above) will affect the wave; i.e. how far away from the start point the sound will move. If MODAMT=+00, the sound will remain static. Positive amounts will modulate the sound forward (toward the end of the wave); negative modulation amounts will move the sound back toward the beginning.  
Range = -99 to +99



**WAVEFORM and INHARMONIC Parameters**

When the wave type is WAVEFORM or INHARMONIC, the lower line of the display will be blank. Due to the nature of the waves in these two categories, they contain no Wave parameters other than Delay.

**MULTI-WAVE Parameters**

When the wave type is MULTI-WAVE, there is only one wave which can be selected — ALL-WAVES. With the Multi-wave you have the entire VFX<sup>SD</sup> wave memory (not counting the waves in the DRUM-SOUND and MULTI-DRUM categories) available to play with. The voice will loop (play repeatedly) any number of adjacent waves in memory. The lower line of the display shows:

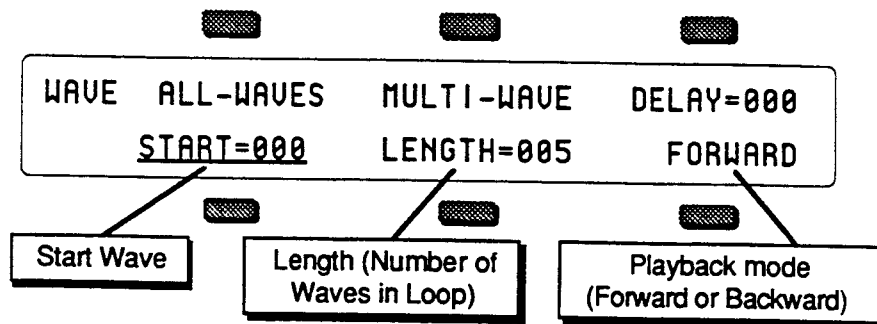
**START**

Start Wave - Picks which of the waves in memory the loop will start on.  
Range = 000 to 249

**LENGTH**

Length of Loop - Controls how many waves will be included in the loop.  
Range = 000 to 243

**FORWARD/REVERSE**

Playback Mode - Controls whether the multi-wave will be played forward or backward.

This programmable multi-wave loop allows the creation of an almost infinite variety of timbral and rhythmic structures. Experiment with different start points and lengths to get an idea of how dynamic (and often amusing) this type of wave can be. Combining delays and repeat envelopes with multi-wave loops can also yield some interesting results.

**VFX<sup>SD</sup> Drum Sounds**

The VFX<sup>SD</sup> contains two wave classes which are *not* common to the VFX:

- DRUM-SOUNDS contains 17 individual drum sounds, each presented as a single (not multisampled) wave covering the entire keyboard.
- MULTI-DRUM contains multisampled combinations of the above waves and the original VFX Drum and percussion sounds (contained in the PERCUSSION Wave-type).

These waves are unique to the VFX<sup>SD</sup>, and programs in which they are used will not sound properly on a VFX. When such a sound is played on a VFX, any voice which has been assigned to play a VFX<sup>SD</sup> drum wave will play the WOOD-BLOCK wave (the first wave in the PERCUSSION wave class) instead.

**MULTI-DRUM Wave Layouts**

The 15 waves in the MULTI-DRUM category provide different combinations of the individual waves in the DRUM-SOUND and PERCUSSION classes. These waves have been designed to provide maximum flexibility for creating custom drum kits while adhering to a basic

- The ALL-PERC wave contains all the miscellaneous percussion sounds in the VFX<sup>SD</sup> (including those from the PERCUSSION and DRUM-SOUND wave classes) arrayed across the keyboard in one multi-sampled wave.

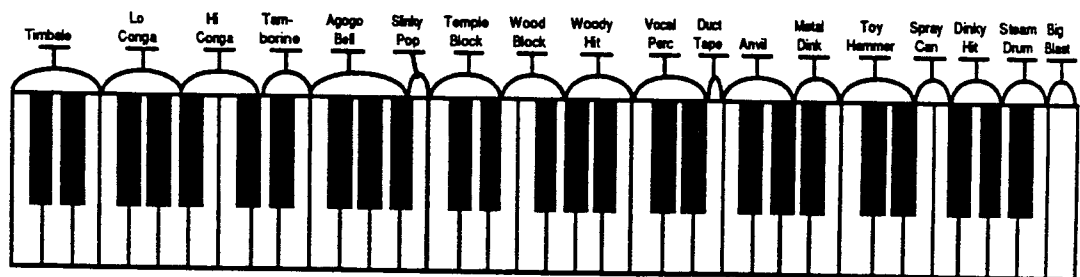

- The ALL-DRUMS wave contains all the drum (and one octave of key percussion) sounds in the VFX<sup>SD</sup> arrayed across the keyboard in one multi-sampled wave.

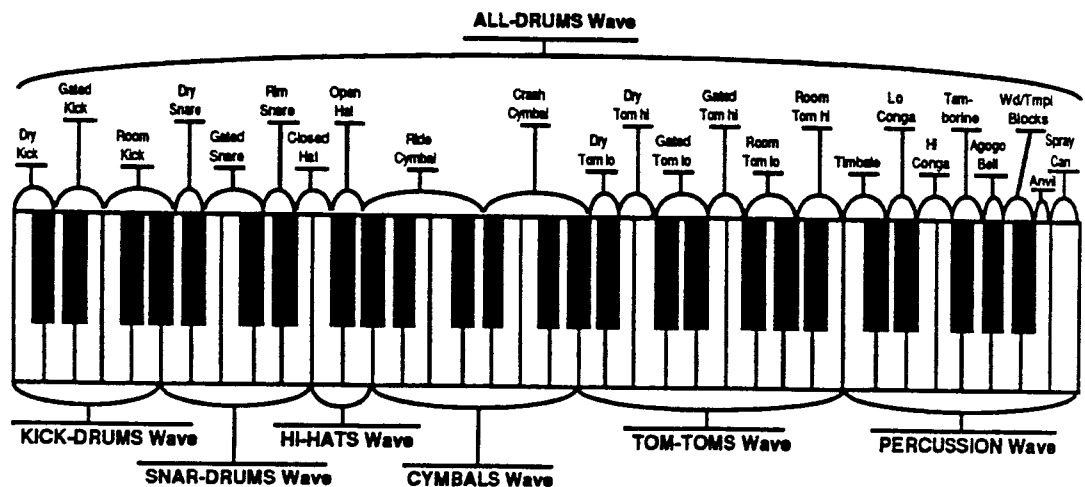

- The KICK-DRUMS, SNAR-DRUMS, HI-HATS, CYMBALS, TOM-TOM, and PERCUSSION waves are *sub-groups* of the ALL-DRUMS wave as

illustrated above. When selected, these waves will play *only* on the section of the keyboard indicated in the illustration, exactly as if you had selected the ALL-DRUMS wave and used the keyboard zone function on the Output page to restrict the voice to that area of the keyboard. These waves are provided as an easy way for you to assign those particular sounds, pre-zoned, to different voices so that each can be treated with its own volume, filter and envelope settings, etc.

- The DRY-TOMS, ROOM-TOMS, GATE-TOMS and CONGAS waves each consist of two samples, with a split point around middle C, allowing you access to both toms or both congas in a single voice. (These same drums individually can be found in the DRUM-SOUNDS wave class.) Change the octave and/or semitone to move the split point to a different keyboard location.
- The last three waves — STD-KIT, GATED-KIT and ROOM-KIT — each provide a matching kick drum, snare drum and tom-toms already mapped into the proper keyboard zones, with "holes" on the rest of the keyboard. Using one of these waves in conjunction with other MULTI-DRUM waves allows you to use just one voice for the kick, snare and toms, and to separately program (and process) the hi-hat, cymbals and whatever percussion or other miscellaneous sounds you want.

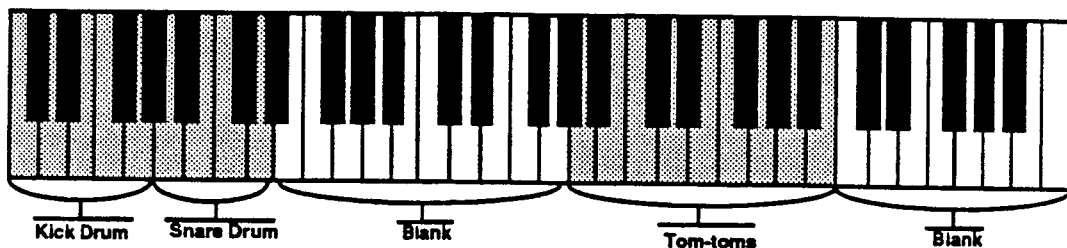

Layout of STD-KIT, GATED-KIT and ROOM-KIT Waves

## Pitch Page

On the Pitch page you set the "manual" levels for the pitch of the voice, and select which pitch-table the voice will use.

On the Select Voice page, select a voice to edit, then press *Pitch*. The display shows:

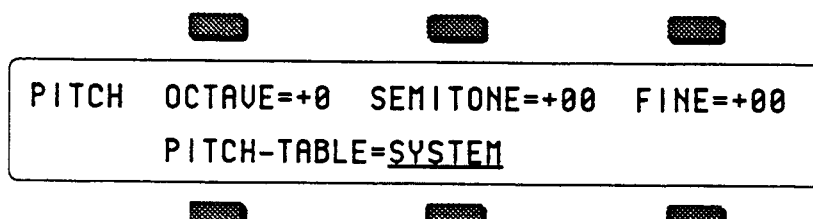

```
PITCH OCTAVE=+0 SEMITONE=+00 FINE=+00
PITCH-TABLE=SYSTEM
```

### OCTAVE

Changes the pitch of the oscillator by octaves.  
Range: -4 to +4 octaves

### SEMITONE

Changes the pitch of the oscillator by semitones. Incrementing/decrementing this control beyond +11 or -11 automatically increases/decreases the octave by one.

### FINE

Changes the pitch of the oscillator by steps of one cent (1/100 of a semitone).  
Range: -99 to +99

### PITCH-TABLE

Pitch-tables let you map the keys on the keyboard into individual pitches—that is, user-definable tuning for each note on the keyboard. This parameter lets you select which pitch-table the voice will use.

When you create a custom pitch-table the VFX<sup>SD</sup> keeps the table inside the program. Within the program, the custom pitch-table uses the space normally used to store the parameters for voices 5 and 6. Therefore, when there is a custom pitch-table in the program, these two voices are not available, replaced on the Select Voice page by the EDIT PITCH TABLE function. Of the remaining four voices, each individual voice can be set to use either the system pitch-table, no pitch, or a custom pitch-table.

- **SYSTEM** — Uses whatever is selected as the system pitch-table on the Master page. Normally this is standard twelve-tone equal temperament tuning across the keyboard. However, a custom pitch-table can be copied into the system for use by all the programs. A parameter on the Master page determines whether the System pitch-table will be standard or custom.
- **ALL-C4** — No pitch tracking — the same pitch (C4) plays across the keyboard.
- **CUSTOM** — User definable pitch-table. This option is only available if a custom pitch-table has been created in the program (see Section 9 for more).

## Pitch Mod Page

On the Pitch Mod Page you apply modulation to the pitch of the voice. Envelope 1 and the LFO are always available to modify the pitch, and you can choose one additional modulator. Also this is where you select a Glide mode for the voice.

On the Select Voice page, select a voice to edit, then press *Pitch Mod*. The display shows:

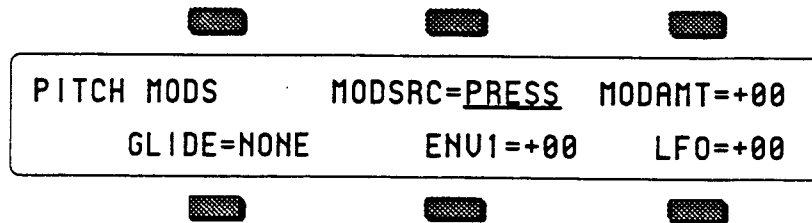

### MODSRC

Modulation Source — Selects a modulator for the pitch of the voice from among the 15 available modulation sources.

### MODAMT

Modulation Amount — Determines the amount or depth by which the modulation source will affect pitch.

Range: -99 to +99

### GLIDE

Enables Glide (portamento) and several forms of monophonic voice assignment in a program. All six voices in a program use the same Glide time, but each voice selects whether it will glide or not. Glide time for the program is set on the Program Control Page. There are five GLIDE modes:

- **NONE** — Glide is off. This is normal polyphonic operation, with no portamento.
- **PEDAL** — Enables the sustain pedal to trigger glide and to control polyphony. When the pedal is not pressed, the voice behaves normally. When you depress the sustain pedal, the number of keys you are holding down defines the polyphony for as long as the pedal is down. While the pedal is down, new voices will be *stolen* from the ones already playing. For example, if there are three notes sounding, and you depress the sustain pedal, the VFX<sup>SD</sup> will play with three-note polyphony as long as the pedal is down, and those same three voices will continue to be stolen and will glide to the new notes.
- **MONO** — Similar to mono mode on old analog synths. The voice will play with one-note polyphony, and new notes will always glide from the previous note (assuming Glide time is greater than zero on the Program Control page). If you just want mono voice assignment without glide, set to GLIDE=MONO and set the Glide time to zero on the Program Control page. Or use GLIDE=TRIGGER if you want mono voice assignment without "note memory" (see below).

- **LEGATO** — When **GLIDE=LEGATO**, if you release a note the VFX<sup>SD</sup> "forgets" that note. The VFX<sup>SD</sup> will not glide to notes when you play staccato
  - play a new key with no other keys down. It will glide when you play legato
  - play a new key while another key is down.

**Note:** Both **MONO** and **LEGATO** feature "note memory" — if you release a key while still holding down another key, the pitch will return to note you are holding.

- **TRIGGER** — Same as **LEGATO** mode, except without the "note memory." When you release a key the voice does not re-trigger or glide, even if another key is being held down.

### ENV 1

**Envelope 1 Amount** — Determines the amount or depth by which Envelope 1 will affect pitch.

Range: -99 to +99

### LFO

**Low Frequency Oscillator Amount** — Determines the amount by which the LFO will affect the pitch of the voice. LFO is most commonly used for vibrato, but can create many unusual effects.

Range: -99 to +99

## Filters Page

Each VFX<sup>SD</sup> voice has its own pair of digital filters, FILTER 1 and FILTER 2, which are connected in series. The filter settings determine which ranges of frequencies will be allowed to pass through to the output.

### Low-pass/High-pass

A low-pass filter allows only those frequencies below the filter cutoff frequency to pass — higher frequencies are filtered out. The reverse is true for a high-pass filter — it lets frequencies higher than the cutoff frequency pass and filters out those below. In the VFX<sup>SD</sup> FILTER 1 is always a low-pass filter. FILTER 2 can be either a high-pass or low-pass filter.

### Poles: Rolloff Curves

"Pole" is an engineering term which describes the steepness of a filter, or the filter's cutoff *slope*. Each additional pole gives a filter a steeper rolloff curve. In the VFX<sup>SD</sup>, the filter modes are interdependent; that is, the combined number of poles in FILTER 1 and FILTER 2 is always four.

These four poles are divided between the two filters; either as 2 and 2, or as 3 and 1. There are two FILTER Pages; however, if you change the number of poles on either page, you will change number of poles on the other page — high-pass will remain high-pass, but the number of poles will change.

A 1-pole filter will rolloff at 6 dB per octave; a 2-pole filter, 12 dB per octave; a 3-pole filter, 18 dB per octave; and 4-pole filter, 24 dB per octave. To reproduce a 4-pole low-pass filter (for that "classic" analog synth sound) you would set both low-pass filters to roll off at 12 dB per octave, resulting in a 24 dB per octave rolloff.

### Cutoff Frequency

Every filter has a "knee" in the response curve, known as the cutoff frequency. This is the frequency at which the filter begins filtering out frequencies. The filter cutoff frequency can remain fixed over time, or it can be varied by modulating the filter with an envelope, LFO, velocity, etc. You can create some very interesting filter configurations by using a different modulator for each filter. For instance, try using pressure to modulate the filters. You can drive one filter up with pressure, while simultaneously driving the other down.

## FILTER 1 Page

Press the *Filters* button. This takes you to the Filter 1 Page:

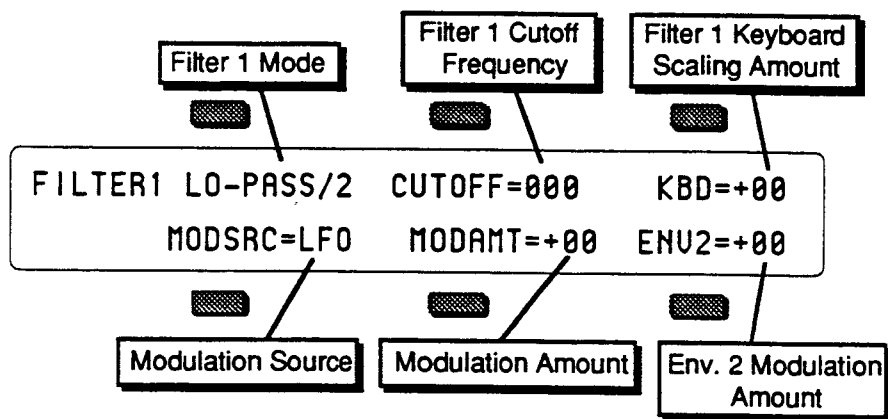

### LO-PASS/2, 3

**Filter 1 Mode** — Determines whether Filter 1 will be a 2-pole or 3-pole low-pass filter. Underline the LO-PASS/2 parameter and use up arrow button the change the pole configuration.

### CUTOFF

**Filter 1 Cutoff Frequency** — Determines the initial, or manual, filter cutoff frequency. With a low-pass filter, a setting of 127 lets all the original signal pass through the filter. Lower settings lower the cutoff frequency, somewhat like turning down the treble on a stereo.  
Range: 000 to 127

### KBD

Sets the amount by which the location of a note on a keyboard will modulate the filter cutoff frequency (keyboard filter tracking). To have the filter track the keyboard exactly, set KBD=+50.  
Range: -99 to +99

### MODSRC

Selects the source of modulation for the filter cutoff frequency from among the 15 available modulation sources.

### MODAMT

Determines the amount or depth by which the modulation source will affect the filter cutoff frequency  
Range: -99 to +99

### ENV 2

Determines the amount or depth by which envelope 2 will affect the filter cutoff frequency.  
Range: -99 to +99



## FILTER 2 Page

Press the *Filters* button again. The display shows Filter 2's page:

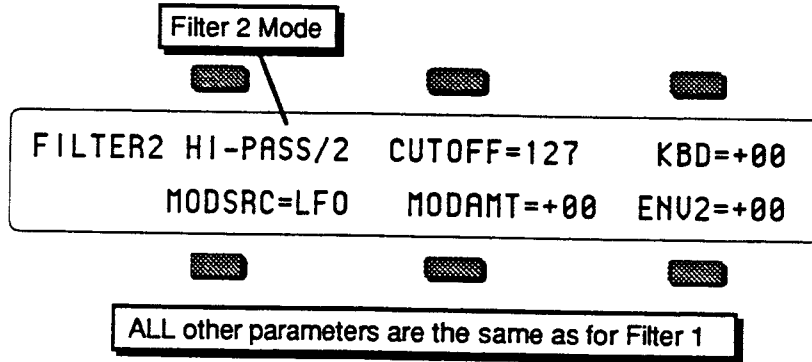

### HI-PASS/2, 1 or LO-PASS/2, 1

Filter 2 Mode — FILTER 2 can be configured as a 2-pole or 1-pole high-pass filter, or a 2-pole or 1-pole low-pass filter.

### CUTOFF, KBD, MODSRC, MODAMT, ENV2

Parameters and ranges are the same as for FILTER 1.

### Filter Configurations

The diagrams below show a number of possible filter configurations. On the left are the response curves of the two filters shown separately. On the right are some of the possible shapes of the combined filters.

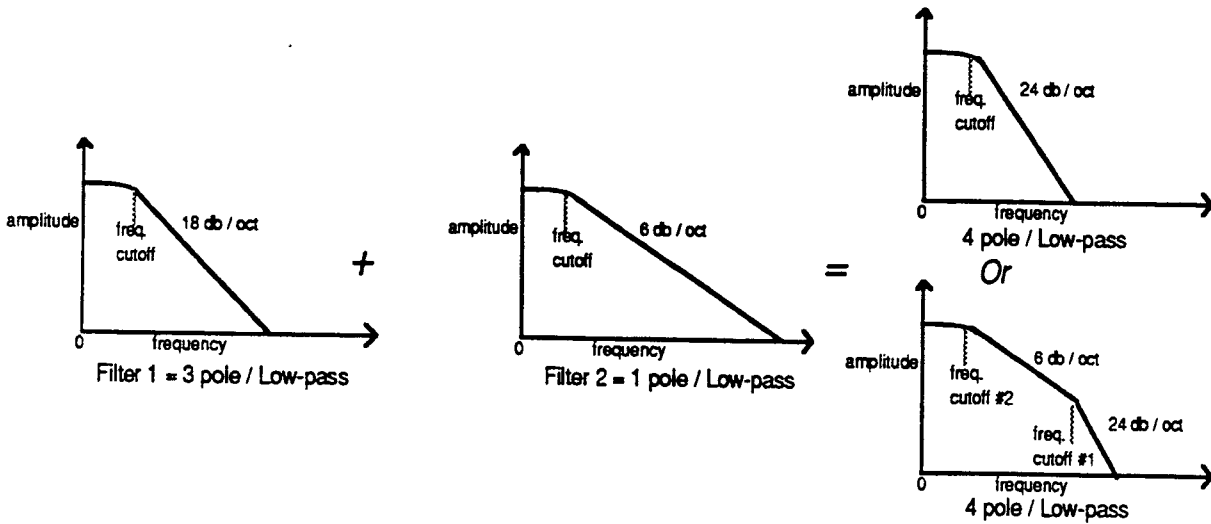

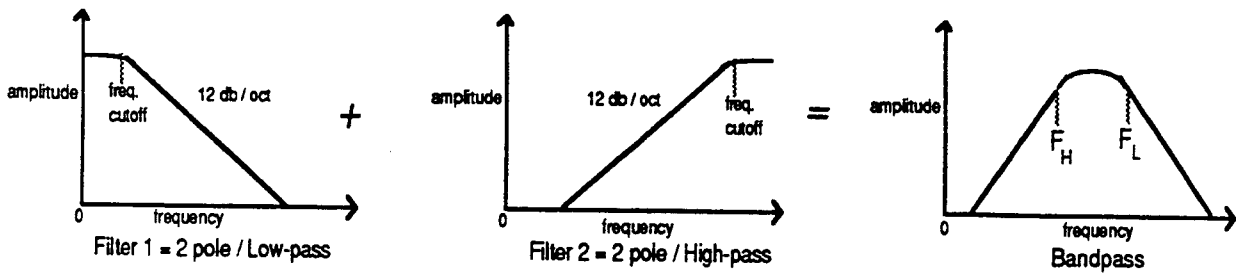
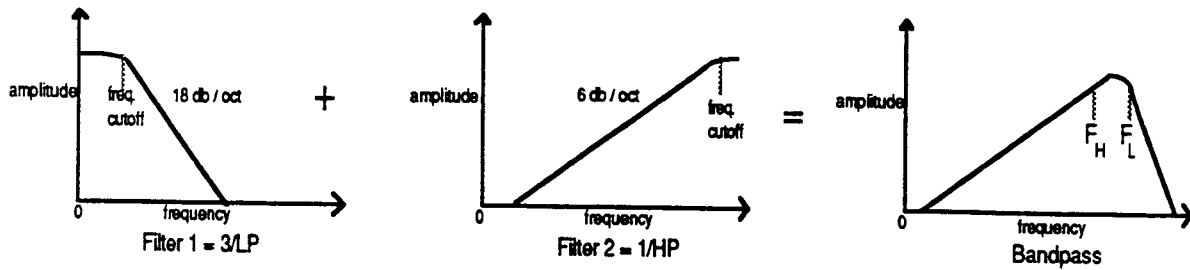
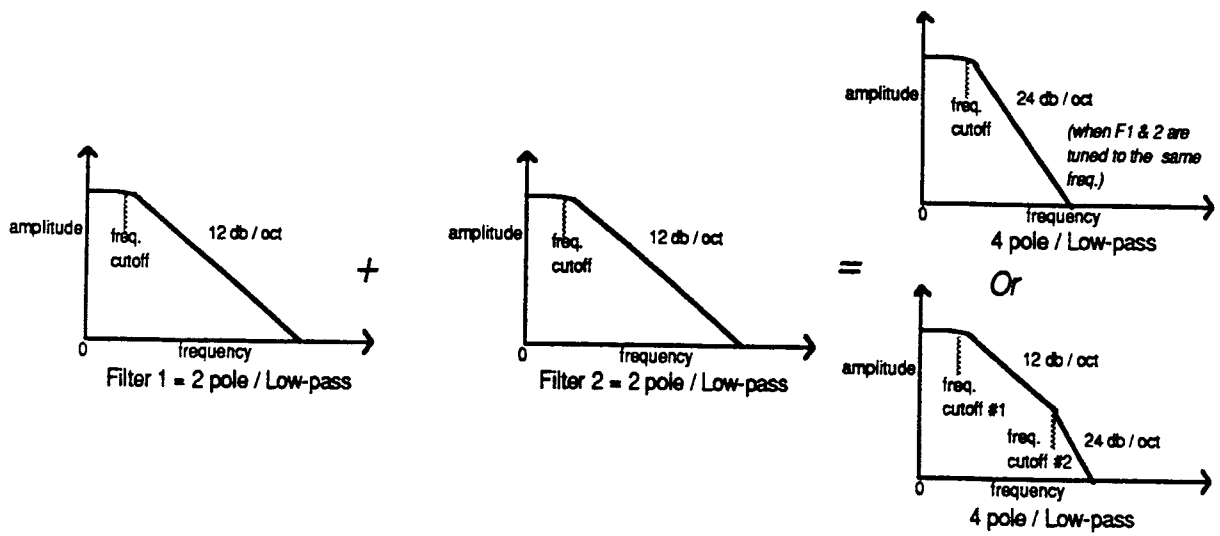

## Output Page

The parameters on the Output page, along with Envelope 3, control the overall volume and panning of the voice, along with keyboard scaling, effects routing and voice reassignment, or "voice stealing" priority. The Output page consists of three separate sub-pages — pressing the Output button again advances to the next sub-page.

Choose the voice you want to edit on the Select Voice page, then press *Output*. The first sub-page contains the following parameters:

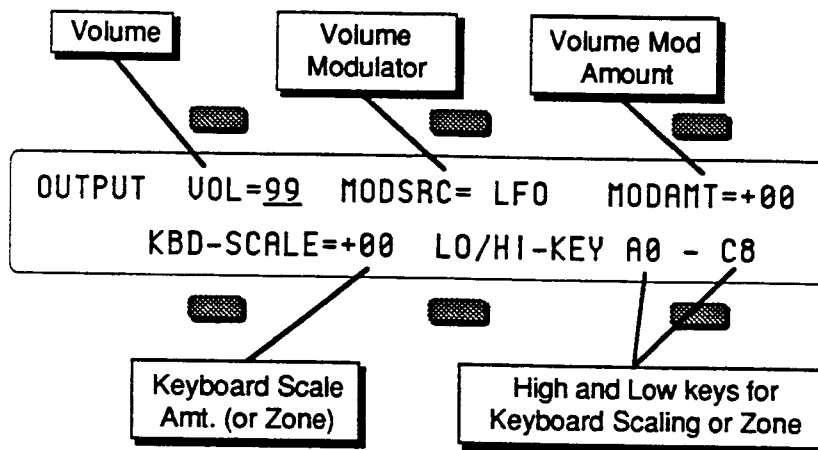

### VOL

**Voice Volume** — Adjusts the overall volume of the voice. Since Envelope 3 is permanently routed to the volume of the voice, this parameter could also be thought of as Env 3 Amount.  
Range: 00 to 99

### MODSRC

**Volume Modulator** — Selects one of the 15 available modulators to affect the volume of the voice. This is in addition to Env 3, which is always routed to volume.

### MODAMT

**Volume Modulator Amount** — Determines how much the modulator selected above will affect the volume of the voice.  
Range: -99 to +99

The two parameters on the lower line of the display provide a powerful tool for shaping the volume of the sound across the keyboard:

### KBD-SCALE

**Keyboard Scale Amount (or Zone)** — Can be used to fade the voice in or out between the two keys specified to the right (see below). This is good for doing keyboard crossfades between voices, or for reducing the volume of a particular voice as you go higher up the keyboard. A value of +99 will fade the voice *in* from silence to full level between the low and high keys. A value of -99 will fade the voice *out* from full level to silence between the low and high keys. Intermediate values will will scale the voice from full level to an intermediate level.

**Setting a keyboard zone**

Moving the data entry slider all the way down to the bottom position (below -99) selects KBD-SCAL=ZON. In this position the voice will sound only over the keyboard range specified by the low and high keys. When KBD-SCAL=ZON, the volume scaling function is not in effect — the voice will play at the same volume throughout the zone.

**LO/HI-KEY**

Low and High Key — Sets the key range over which the fade-in, fade-out or keyboard zone will occur. When this parameter is selected, notes can be entered from the keyboard or using the data entry slider or up and down arrow buttons. Select this parameter and play the low key; that note is entered as the low key, and the cursor switches to the high key. Now play the high key; that note is entered as the high key, and the cursor disappears. If you made a mistake, or want to enter a different range of values, just select the parameter again and repeat the process.

Press *Output* again. The display shows the second sub-page:

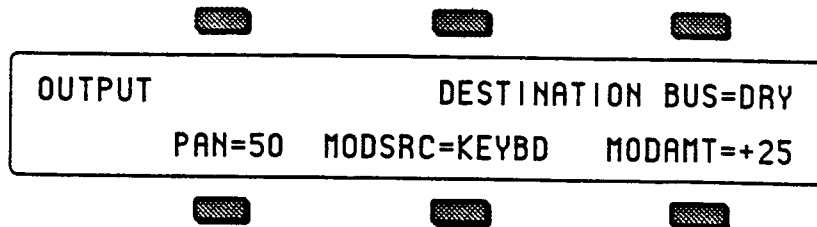

**DESTINATION BUS**

Each voice within a program can be routed to one of four stereo "busses."

- Three of these busses, DRY, FX1 and FX2, feed the main stereo outputs of the VFX<sup>SD</sup>.
- The fourth buss, AUX, sends the voice directly to the Aux Outputs of the VFX<sup>SD</sup>. Note that voices sent to the Aux Outputs are *always* dry; that is they bypass the effects processor.

The diagram below shows the routing of the signals for each bus. See the section on "Effects" for more on programming specific effects.

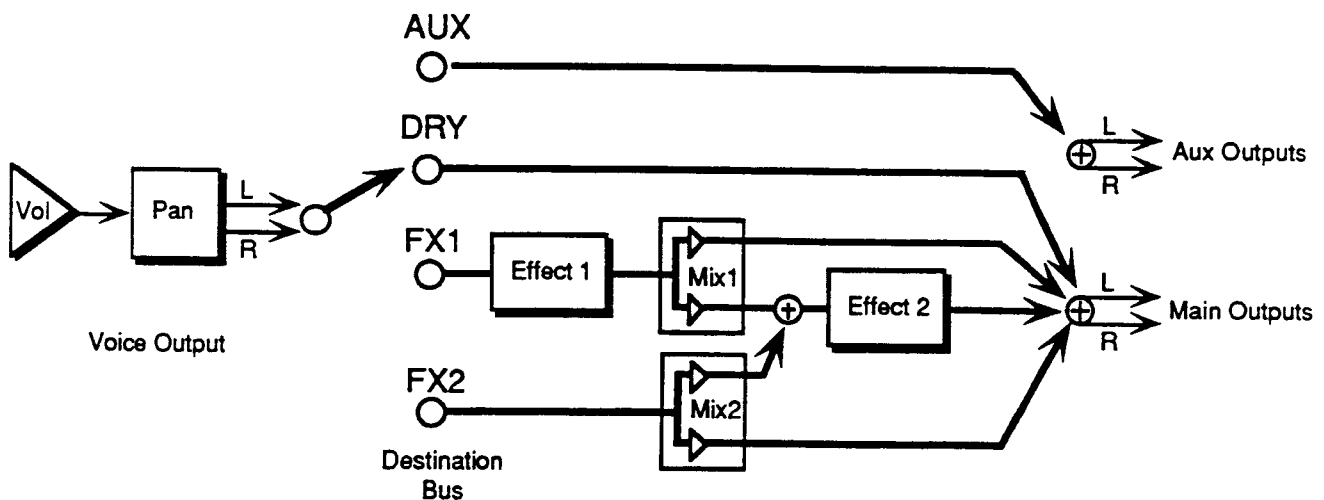

**PAN**

Pan Location — Pans the voice within the stereo mix. This is the starting pan location — the effect of a pan modulator (below) will be added to this. Range is from 00 (panned left) to 99 (panned right). A value of 50 pans the voice center.

**MODSRC**

Pan Modulator — Selects a modulator for the pan from among the 15 available modulators. This will cause the voice's location in the stereo mix to vary with the level of the modulation source.

**MODAMT**

Pan Modulator Amount — Determines how much the Pan Modulator will affect the pan. Here, a negative modulation amount will have the opposite effect as the same-numbered positive value.

Press *Output* a third time. The final sub-page contains three parameters:

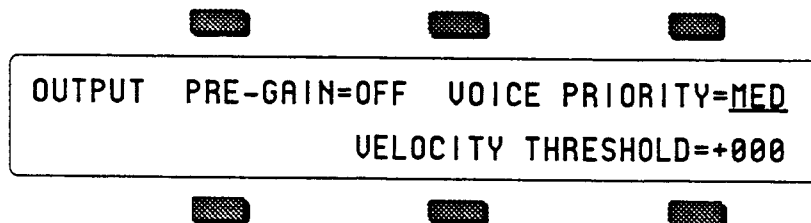
**PRE-GAIN**

Pre-gain applies a fixed boost of 12 dB to volume of the the voice. This is intended to let the programmer compensate for the effects of heavy filtering or enveloping, and for the fact that some waves simply have less apparent loudness than others. For example, a percussion sample, which is by nature a quick peak, has less energy than a sustaining square wave. Pre-Gain lets you raise the level of such waves to equal that of "louder" waves.

A volume level of VOL=62 when Pre-gain is on gives you the same level as VOL=99 with Pre-gain off. Any volume level greater than 62 represents an increase over the usual maximum voice level.

**Warning:**

The pre-gain function is *only* intended to allow you to compensate for heavily filtered or low-energy waves. We strongly recommended against routinely applying pre-gain to all the waves in your sounds just to make them louder — doing so *will* result in clipping (distorting) when you play more than one or two notes.

**VOICE PRIORITY**

This parameter gives you some control over how voices will be reassigned, or "stolen," to play new notes when all of the VFX<sup>SD</sup>'s voices are already playing. A voice can be assigned LO, MED or HI priority. The rule is that a given voice will only be allowed to steal from voices with the same or lower priority.

MED is the usual state and should be used for most voices. LO can be used for voices within a sound which would be missed the least if stolen (such as a voice playing the same wave as another voice but detuned a bit). HI is best used only for specific applications in which you want to protect a voice or voices from being stolen — such as drums or a sustaining "pad" sound in a sequencer track.

**VELOCITY THRESHOLD**

Selects a key velocity below which, or above which, the voice will not sound. This allows velocity switching between different voices within the sound. The range is from -127 to +127. When the value is +000, the parameter will have no effect. Values from +001 to +127 mean that the voice will only play when the key velocity is *equal to or greater* than the number shown. Values from -001 to -127 mean that the voice will only play when the key velocity is *less than* the number shown.

### LFO Page

The LFO Page contains the parameters related to the Low Frequency Oscillator. Each voice in a program has its own LFO, which can be assigned as a modulator wherever a modulation source is selected. LFO's are commonly used to create vibrato, tremolo and other effects.

On the Select Voice page, select the voice you want to edit, then press *LFO*. This takes you to the first sub-page of the LFO Page:

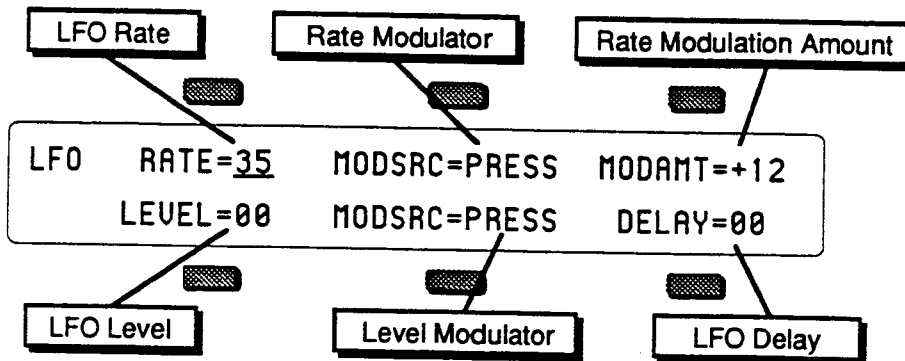

### RATE

**LFO Rate** — Determines the speed of the LFO.  
Range: 00 to 99. The table below shows the frequency (in hertz) for each value:

LFO FREQUENCIES

value	time (in Hz)	value	time (in Hz)	value	time (in Hz)	value	time (in Hz)	value	time (in Hz)
0	.05	20	1.25	40	6.25	60	11.25	80	16.25
1	.05	21	1.50	41	6.50	61	11.50	81	16.50
2	.06	22	1.75	42	6.75	62	11.75	82	16.75
3	.06	23	2.00	43	7.00	63	12.00	83	17.00
4	.06	24	2.25	44	7.25	64	12.25	84	17.25
5	.07	25	2.50	45	7.50	65	12.50	85	17.50
6	.07	26	2.75	46	7.75	66	12.75	86	17.75
7	.08	27	3.00	47	8.00	67	13.00	87	18.00
8	.08	28	3.25	48	8.25	68	13.25	88	18.25
9	.09	29	3.50	49	8.50	69	13.50	89	18.50
10	.10	30	3.75	50	8.75	70	13.75	90	18.75
11	.11	31	4.00	51	9.00	71	14.00	91	19.00
12	.13	32	4.25	52	9.25	72	14.25	92	19.25
13	.14	33	4.50	53	9.50	73	14.50	93	19.50
14	.17	34	4.75	54	9.75	74	14.75	94	19.75
15	.20	35	5.00	55	10.00	75	15.00	95	20.00
16	.25	36	5.25	56	10.25	76	15.25	96	20.25
17	.33	37	5.50	57	10.50	77	15.50	97	20.50
18	.50	38	5.75	58	10.75	78	15.75	98	20.75
19	1.0	39	6.00	59	11.00	79	16.00	99	21.00

### MODSRC

**LFO Rate Modulation Source** — Selects a modulation source for LFO RATE from among the 15 available modulators.

**MODAMT**

LFO Rate Modulation Amount — Determines the amount by which the RATE modulator will affect the LFO rate.  
Range: -99 to +99

**LEVEL**

LFO Level — Sets the "manual" level (or depth) of the LFO. Level controls the initial amount of LFO. The effect of any LFO modulator will be added to this amount.  
Range: 00 to 99

**MODSRC**

LFO Level Modulation Source — Selects the modulation source for LFO LEVEL. The effect of this modulator is *added* to the value set in LEVEL. Either parameter can trigger the LFO. If you have LEVEL set to zero, you can still get LFO modulation by using any of the 15 modulation sources.

**DELAY**

Determines the time it takes for the LFO to go from zero to the level set with the LEVEL parameter. This is useful for creating delayed vibrato, tremolo, etc. Higher values give longer delay times.  
Range: 00 to 99

Press *LFO*, again to access the second sub-page of the LFO Page. The display reads:

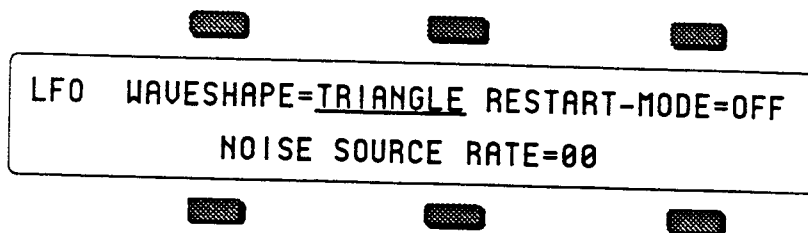

LFO WAVESHAPE=TRIANGLE RESTART-MODE=OFF  
NOISE SOURCE RATE=00

**WAVESHAPE**

The Waveshape determines how the signal will rise and fall. There are seven possible values:

- TRIANGL — the triangle wave is commonly used to modulate the LFO to produce vibrato.
- SINE — the sine wave is a pure fundamental frequency, more abrupt in its peaks and valleys than the triangle wave.
- SINE/TRI — a mixture of a sine and triangle wave, a sort of pointy sine wave.
- POS/SIN — the POS/SIN is similar in application to the POS/TRI.
- POS/TRI — the POS/TRI is a positive-only triangle wave useful for simulating vibrato on instruments like the guitar where vibrato techniques are limited to bending the note up.
- SAWTOOTH — the sawtooth wave is commonly used for special effects.
- SQUARE — the square wave is useful for producing trill effects.



**LFO Waveshapes**

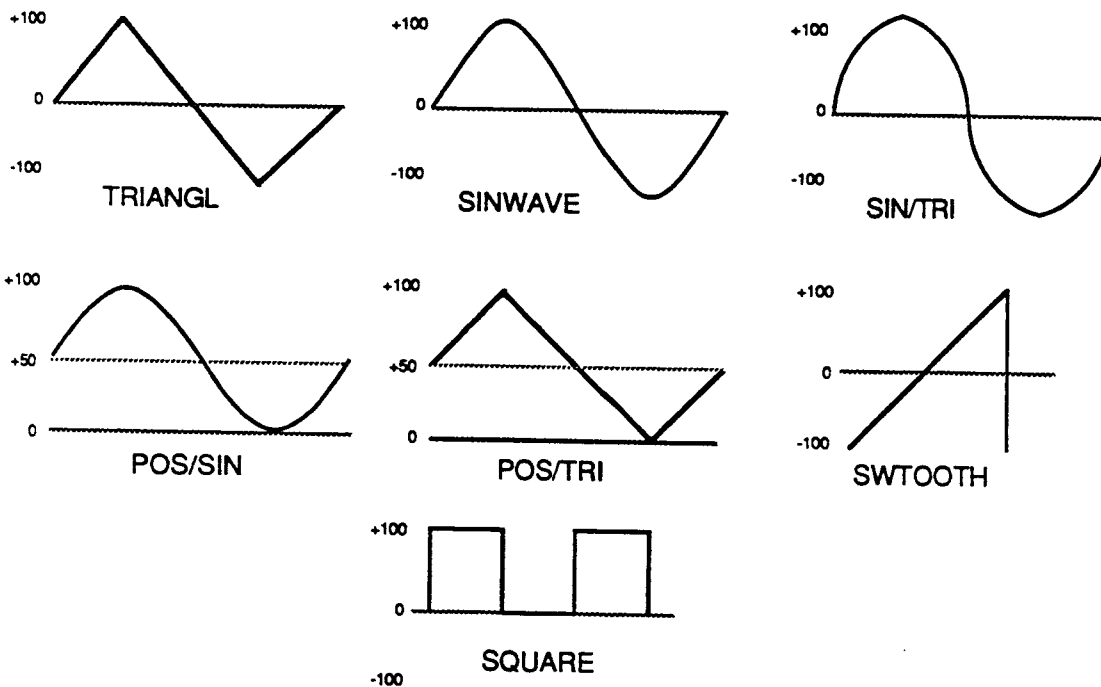

**RESTART MODE**

Determines whether the LFO will restart with each keystroke: When set to OFF, the LFO will cycle continuously without resetting. When set to ON, the LFO waveform will return to the beginning of its cycle each time a new key is struck.

**NOISE SOURCE RATE**

One of the VFX<sup>SD</sup>'s 15 available modulation sources is NOISE. The Noise modulator is a signal whose level varies by random amounts. Typically, it might look like this:

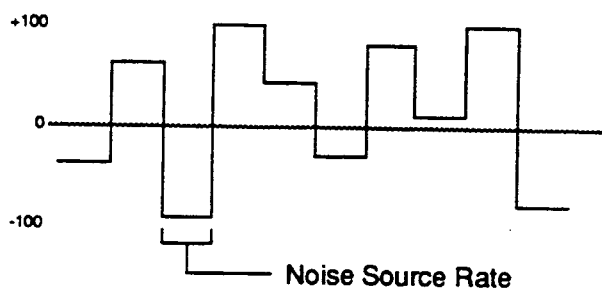

The Noise Source Rate defines how frequently the level will change. Low values will cause it to change very slowly; with high values the level will change quickly.  
Range: 00 to 99

## ENV 1, ENV 2, ENV 3 — VFX<sup>SD</sup> Envelopes

An *Envelope* is a shape, or contour, which we apply to a signal source to make it change over time. Each VFX<sup>SD</sup> voice has three envelopes. These envelopes are automatically routed to the pitch, filter frequency and amplitude of the voice, though ENV 1 and ENV 2 can also be assigned elsewhere, wherever a modulator is selectable.

- ENV 1 is routed to the pitch of the voice. There is a parameter always available on the Pitch Mod page which lets you adjust the amount by which ENV 1 will modulate the voice's pitch.
- ENV 2 is routed to the filter cutoff frequency of the voice. For each of the voice's two filters, the parameter labeled ENV 2=\_\_ on the Filters page controls ENV 2 depth.
- ENV 3 is routed to the amplitude (volume) of the voice. ENV 3 *always* controls the final volume contour of the voice. Any other volume modulators selected on the Output page will occur before ENV 3 in the signal flow.

The VFX<sup>SD</sup> envelopes are descended from the venerable ADSR (attack, decay, sustain, release) envelope, but with many refinements. While the ADSR envelope gives you control over three time segments and one level, the VFX<sup>SD</sup> envelopes give you control over *five* levels and *five* time segments.

The illustration below shows the make-up of a VFX<sup>SD</sup> envelope:

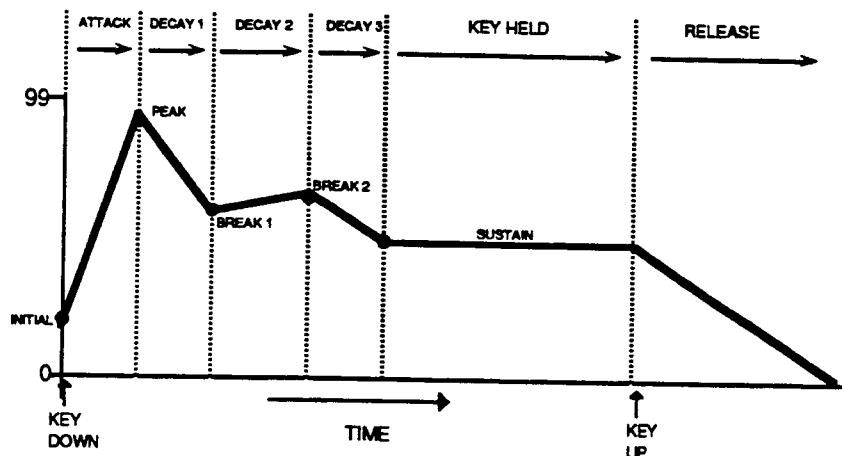

Each envelope page consists of three sub-pages, which are reached by repeatedly pressing the *Env 1*, *Env 2*, or *Env 3* button. For each envelope page:

- The first sub-page contains the five levels: INITIAL, PEAK, BREAK1, BREAK2 and SUSTAIN.
- The second sub-page contains the five time segments: ATTACK, DECAY1, DECAY2, DECAY3 and RELEASE.
- The third sub-page contains the Envelope mode, keyboard scaling, and several parameters for shaping the velocity response of the envelope.

## Editing the Envelopes

**Note:** The ENV 1, ENV 2 and ENV 3 Pages, parameters and ranges are all the same except where indicated below. We will use ENV 3 as our example, since its effect on the volume of the voice is immediately apparent.

Press *Env 3*. This takes you to the first sub-page, which shows the five LEVELS:

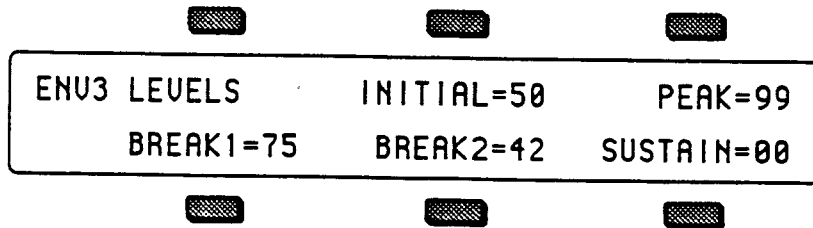

### INITIAL

Determines the level at which the envelope will start when a key is depressed.  
Range: 00 to 99

### PEAK

Determines the level the envelope will reach at the end of the time defined by ATTACK.  
Range: 00 to 99

### BREAK 1

Determines the level the envelope will reach at the end of DECAY 1.  
Range: 00 to 99

### BREAK 2

Determines the level the envelope will reach at the end of DECAY 2.  
Range: 00 to 99

### SUSTAIN

Determines the level the envelope will reach at the end of DECAY 3 and retain as long as the key is held down.  
Range: 00 to 99

Press the *Env 3* button again, to get to the second sub-page, which contains the five TIMES segments:

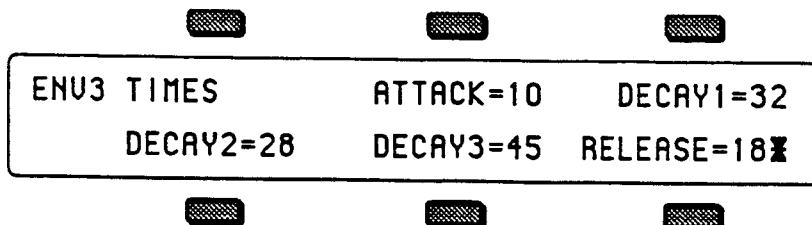

Note that the numbers shown here represent *times*, not rates. That is, the envelope will take a fixed amount of time to go from one level to another no matter what those two levels are.

**ATTACK**

The amount of time it takes for the envelope level to travel from the INITIAL level (when the key is struck) to the PEAK level. The higher the value, the longer the time. This doesn't necessarily have to be an "attack" in the usual sense — the INITIAL level could be set higher than the PEAK level, in which case this would become another decay stage.

Range: 00 to 99 (see the Envelope Times chart below for a listing of the time values).

**DECAY 1**

The time it takes the envelope to go from PEAK to BREAK 1.

Range: 00 to 99

**DECAY 2**

The time it takes the envelope to go from BREAK 1 to BREAK 2.

Range: 00 to 99

**DECAY 3**

The time it takes the envelope to go from BREAK 2 to the SUSTAIN stage. At the end of DECAY 3, the envelope will remain at the SUSTAIN level until the key is released.

Range: 00 to 99

**RELEASE**

This defines the time it will take the envelope to return to zero after the key has been released. Values with a star next to the number *will* be affected by changes to the Performance Release parameter. Values without a star *will not* be affected. This allows you to choose which voices within a program will respond when you edit the Release parameter in performance. (See Section 3 for more.)

Range: 00\* to 99\*, 00 to 99

**ENVELOPE TIMES**

value	time (in sec)	value	time (in sec)	value	time (in sec)	value	time (in sec)	value	time (in sec)
0	.00	20	.20	40	.82	60	3.2	80	13
1	.01	21	.22	41	.88	61	3.5	81	14
2	.02	22	.23	42	.94	62	3.7	82	15
3	.03	23	.25	43	1.0	63	4.0	83	16
4	.04	24	.27	44	1.0	64	4.3	84	17
5	.06	25	.29	45	1.1	65	4.6	85	18
6	.07	26	.31	46	1.2	66	4.9	86	19
7	.08	27	.33	47	1.3	67	5.3	87	21
8	.08	28	.35	48	1.4	68	5.7	88	22
9	.09	29	.38	49	1.5	69	6.1	89	24
10	.10	30	.41	50	1.6	70	6.5	90	26
11	.11	31	.44	51	1.7	71	7.0	91	28
12	.11	32	.47	52	1.8	72	7.5	92	30
13	.12	33	.50	53	2.0	73	8.1	93	32
14	.13	34	.54	54	2.1	74	8.6	94	34
15	.14	35	.58	55	2.3	75	9.3	95	37
16	.15	36	.62	56	2.4	76	9.9	96	39
17	.16	37	.66	57	2.6	77	10	97	42
18	.17	38	.71	58	2.8	78	11	98	45
19	.19	39	.76	59	3.0	79	12	99	49

Press the *Env 3* button again. This displays the final sub-page for ENV 3:

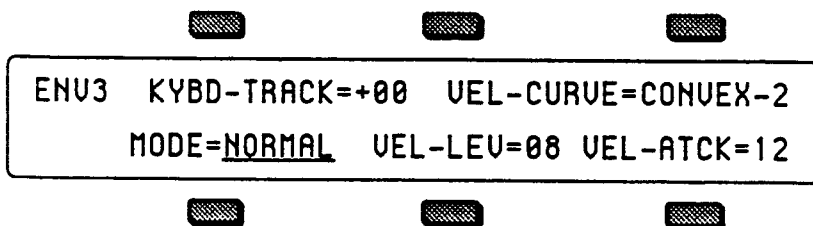

**KYBD-TRACK**

Makes the Envelope time segments longer or shorter depending on the position of the key on the keyboard.

Raising the value of KYBD-TRACK will make all envelope times (except Release) shorter as you play notes above middle C, and longer as you play below middle C — higher notes will decay faster than lower ones. The greater the value assigned to KYBD-TRACK, the greater the difference in decay time between the highest and lowest note. Middle C will always remain the same and is not affected by this parameter.

**VEL-CURVE — Velocity Response Curve**

This selects which of the ten available velocity response curves the envelope will use if the velocity level control (VEL-LEVEL below) is set to some value other than zero. Available values are: QUICKRISE; CONVEX-1; CONVEX-2; CONVEX-3; LINEAR; CONCAVE-1; CONCAVE-2; CONCAVE-3; and LATERISE.

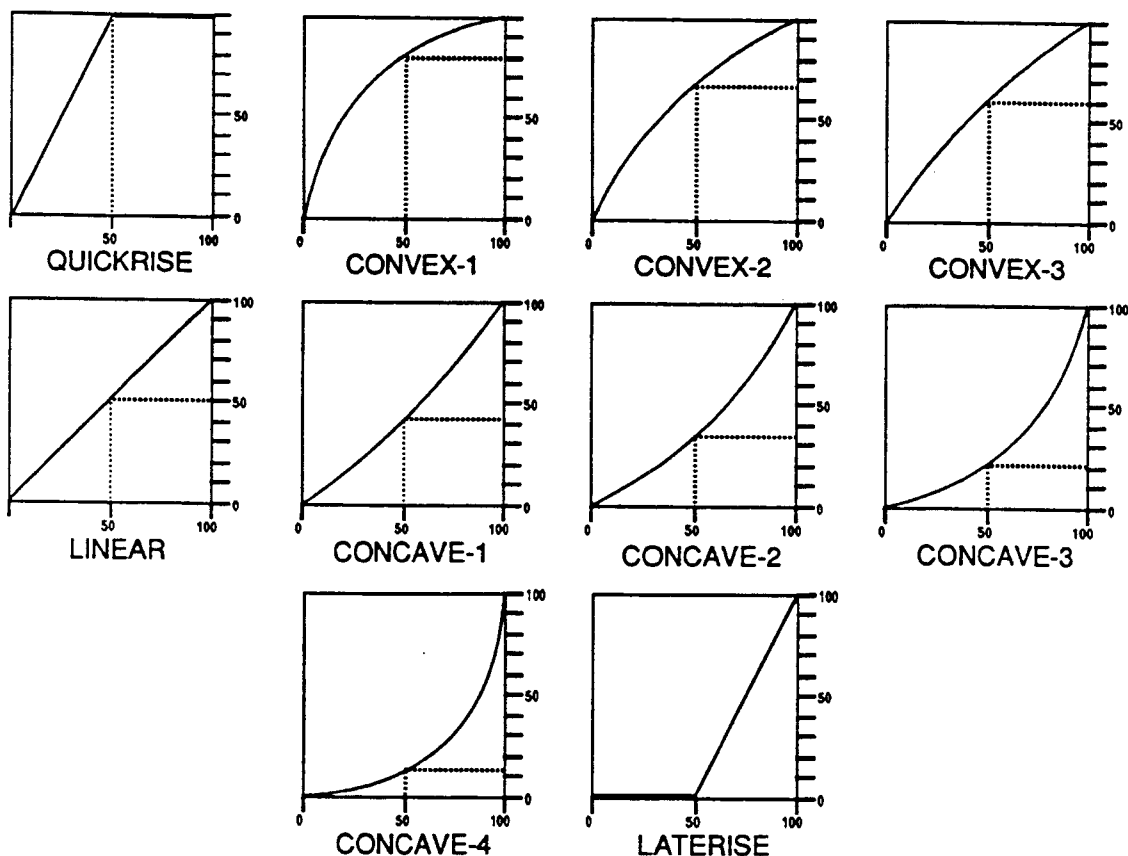

**MODE — (ENV 1 and ENV 2)**

- **NORMAL** — The envelope plays through normally, as shown in the diagram on p. 8-28.
- **FINISH** — The envelope runs its full cycle — *finishes* playing through all its stages — ignoring the key-up event. The envelope spends no time at the sustain stage. As soon as DECAY 3 is finished, instead of stopping at the sustain stage the envelope immediately goes into the release stage. This is good for percussive-type sounds where you want the envelope to be the same for every note, no matter how long the key is held down.
- **REPEAT** — In this mode, at the end of the DECAY3 stage, instead of sustaining, the envelope goes immediately back to the beginning of the envelope and repeats. When the key is released, the envelope stops repeating, and moves into the release stage. This type of envelope can be used to create complex LFO-type effects.

**MODE (ENV 3) — Voice triggering/stealing notes**

Since Env 3 control the volume of the voice there are a number of special considerations to be aware of when using the the different envelope modes:

In **NORMAL** mode, if you set a delay on the voice, and you release the key before the designated delay time elapses, the voice will not sound.

In **FINISH** mode, if you set a delay on the voice and you release the key before the designated delay time elapses, the note will sound anyway. The envelope finishes what you set it up to do.

In **REPEAT** mode the VFX<sup>SD</sup> restarts the wave from the beginning every time the envelope repeats. When envelope gets to the SUSTAIN level, it goes back to the INITIAL level.

In order to maximize the use of the VFX<sup>SD</sup>'s 21 voices, and to manage the "voice stealing" it is sometimes useful to understand when a given voice will be assigned and when it will be released, or "put back" into the pool for use by other sounds. This depends on a combination of envelope mode and the wave type.

A looped (sustaining) wave will continue to use the voice until the envelope reaches zero. For a sustaining wave, when the Envelope Mode is Normal:

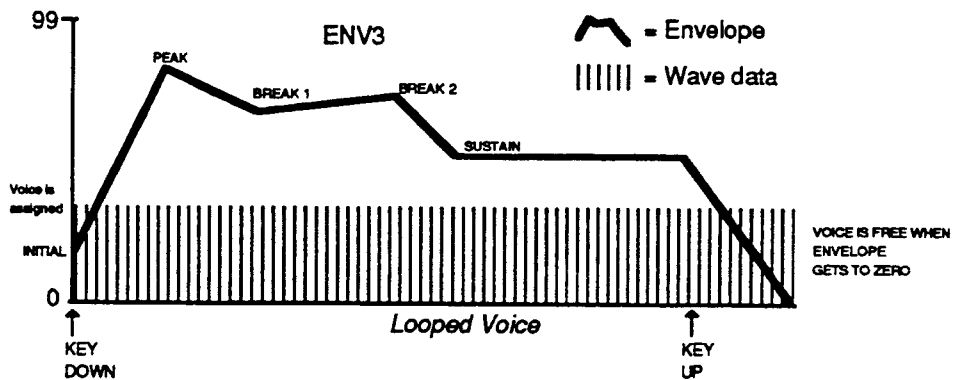

For a sustaining wave, when the Envelope Mode is set to Finish:

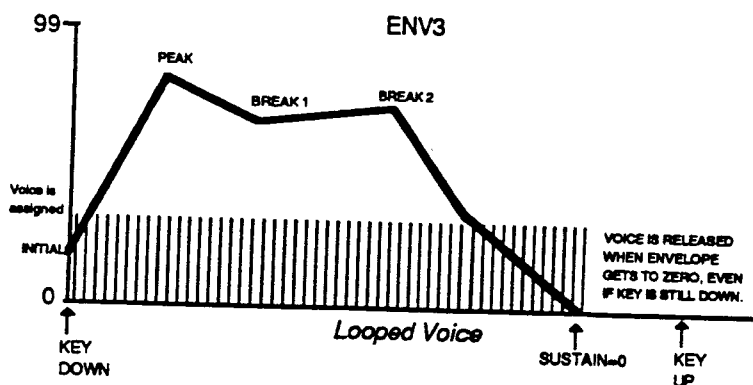

For unlooped, non-sustaining, waves (specifically those in the Percussion and Drum categories) the voice becomes free as soon as the sample has played through to the end, no matter where the envelope level is. The voice is released for use by another sound:

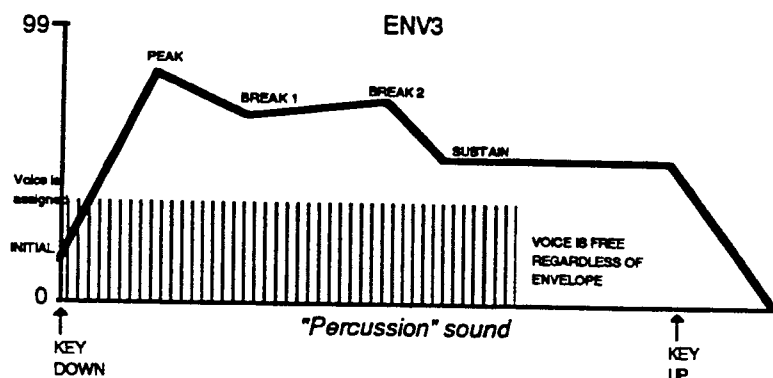

### VEL-LEV — Velocity Level Control

The Velocity level parameter will lower all envelope level settings with a softer keystroke. This means the settings you assign to INITIAL, PEAK, BREAK 1, and BREAK 2 and SUSTAIN are maximum levels, the levels that will be reached with the hardest keystroke. The amount of VEL-LEV will determine how much those levels will be reduced as you play softer. With this parameter you can have continuous dynamic control over the five levels by varying how hard you play. Changing the Velocity Curve (VEL-CURVE above) gives you further control over the velocity response of the envelope.

Range: 00 to 99

### VEL-ATCK — Velocity Attack Control

Velocity attack makes the envelope attack time respond to keyboard velocity. When the value of VEL-ATCK is increased, a harder keystroke will result in a faster attack. Note that this parameter will have no effect if ATTACK = 00.

Range: 00 to 99

## Mod Mixer Page

The Mod Mixer/Shaper is a unique feature which allows you to:

- combine and assign two modulators to a single modulation input, and/or
- scale and/or shape the response of one of those modulators according to one of 16 Mod Shaper Curves.

Select the voice you want to edit on the Select Voice page, and then press *Mod Mixer*. The display shows:

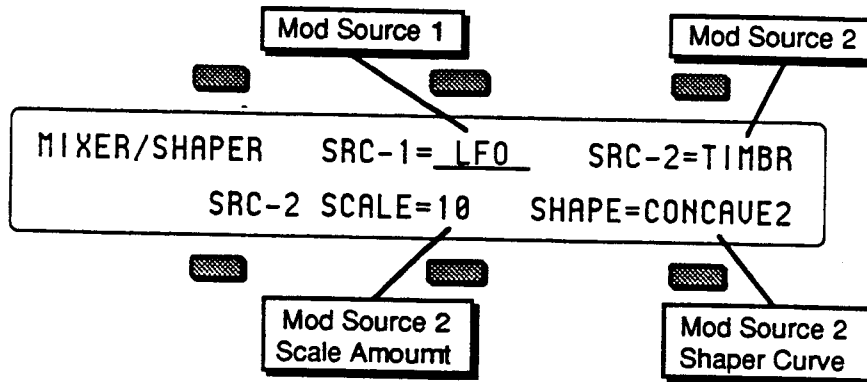

The two controls on the top line of the display select the two modulators which will be mixed together, SRC-1 and SRC-2. On the lower line of the display are two parameters for shaping the level and response of SRC-2. Internally, the Mixer/Shaper works like this:

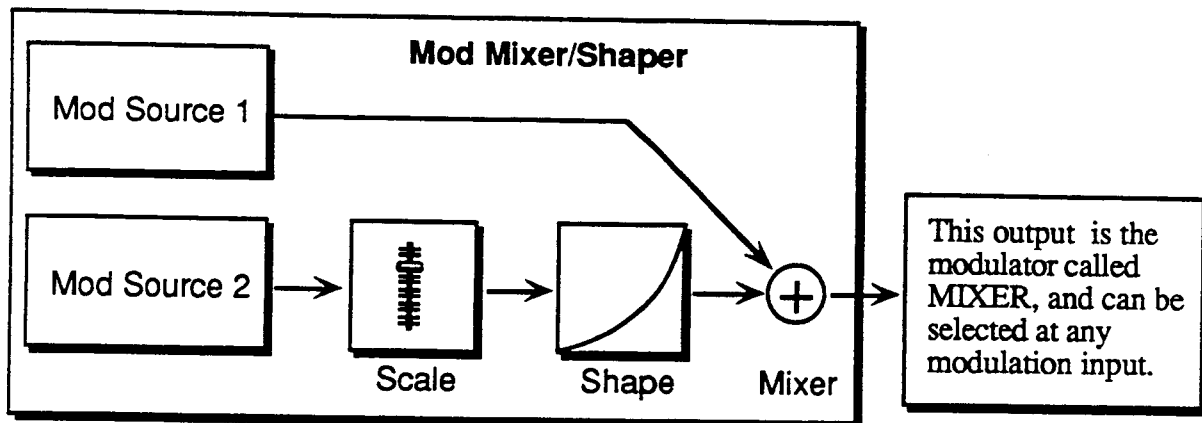

There are four parameters which can be selected on the Mod/Mixer page:

### SRC-1

Select any of the 15 available modulators (including the mixer itself) as Mod Source 1 (SRC-1). SRC-1 is sent directly to the mod mixer without any level change or response shaping.

### SRC-2

Select one of the 15 available modulators as Mod Source 2 (SRC-2). Before being added to SRC-1, SRC-2's level is adjusted by a scale factor, variable from 0.1 to 8.0, and then it is passed through the Shaper, which allows its response to be customized in a number of interesting ways (see below).



**SCALE**

This is used to adjust the level of SRC-2 relative to SRC-1, or to simply scale the level of the modulator for effect. The available scale values are:

- 0.1   0.2   0.3   0.4   0.5   0.6   0.7   0.8
- 0.9   1.0   1.5   2.0   3.0   4.0   6.0   8.0

The modulator's level is *multiplied* by the number shown. A value of 1.0 leaves the modulator at its original level. Fractional values (0.1 to 0.9) will reduce the level. Values greater than 1.0 will amplify the effect of the modulator, in most cases simply causing it to reach full level much sooner.

**SHAPE**

Here you select which of the 16 tracking curves will be applied to the modulator selected as SRC-2. You can use one of the convex or concave shapes to make the modulator's effect come in earlier or later than it ordinarily would; you can use one of the quantized shapes to make the modulator's effect sound "stepped"; or you can use the smoother (which is similar to a "lag processor" in some older analog synths) to smooth the effect of the modulator, to round off the edges, as it were. The figure below shows the 16 Shaper tracking curves:

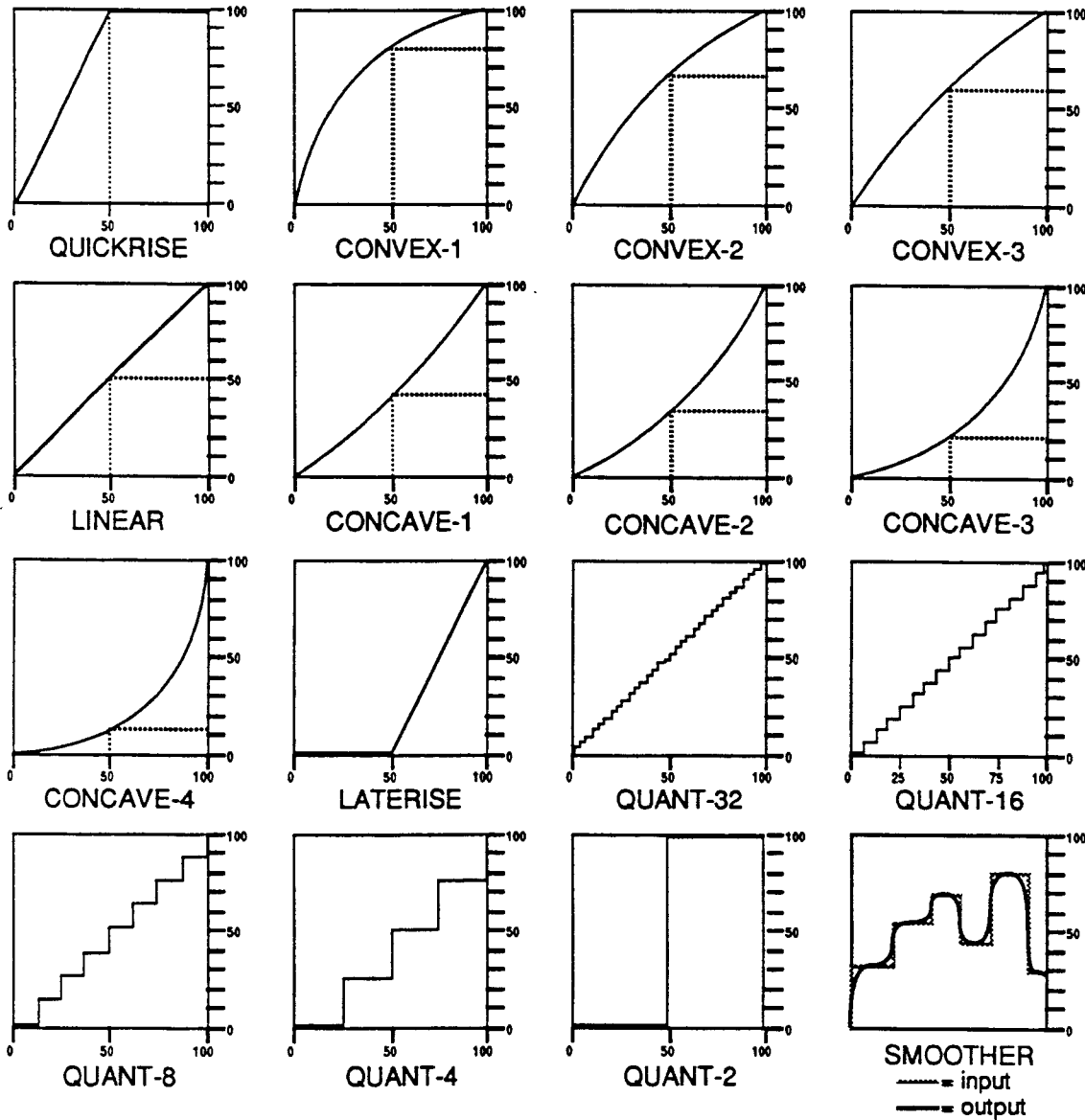

Some possible applications for shaping the response of SRC-2 are shown below:

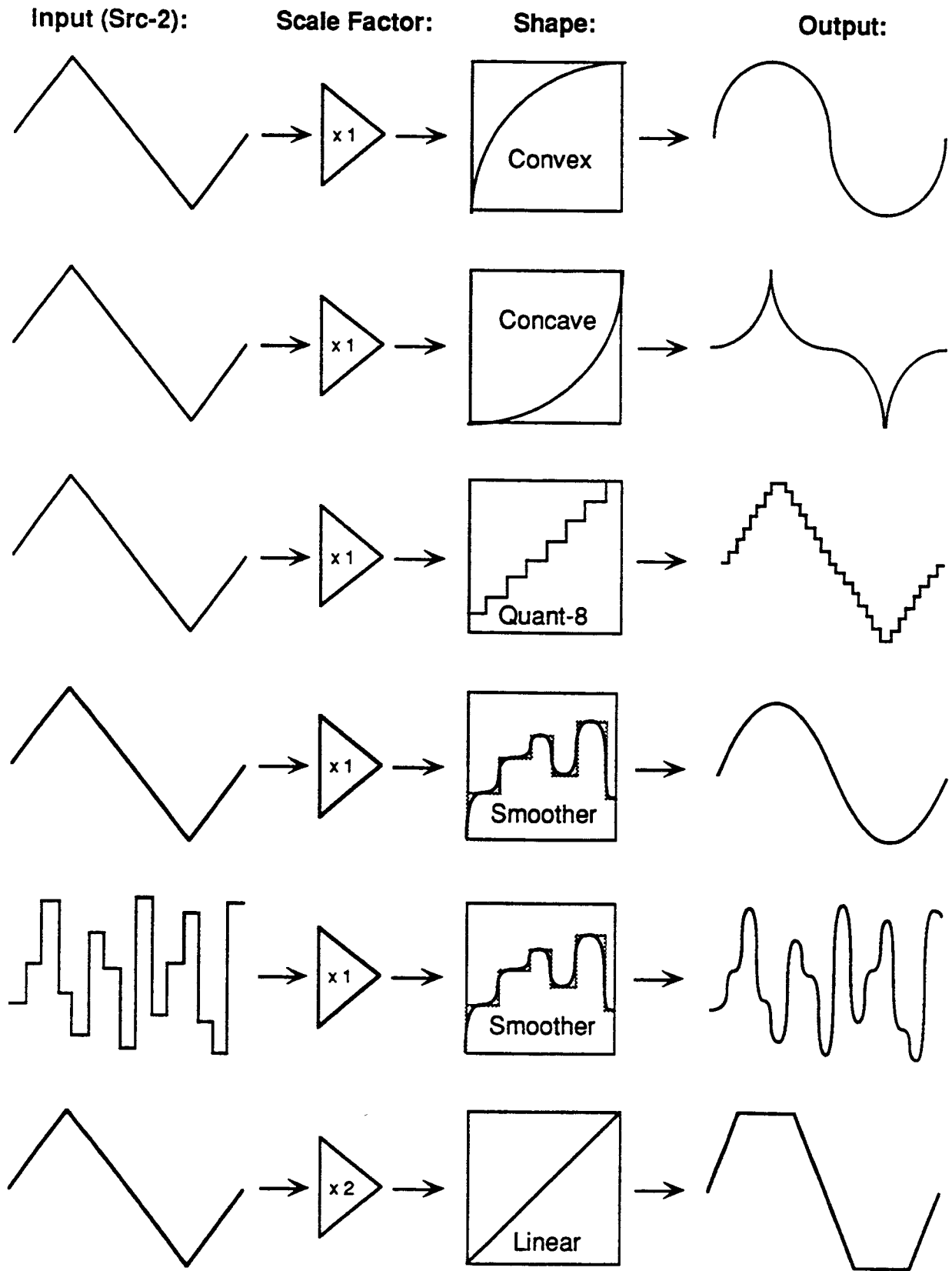

## Section 9 — Using Pitch-Tables

About Pitch-tables . . . . .	9 - 1
How to Create a Custom Pitch-table . . . . .	9 - 2
Editing a Custom Pitch-table . . . . .	9 - 3
Removing a Custom Pitch-table . . . . .	9 - 4
Creating and Extrapolating a Custom Pitch-table . . . . .	9 - 4
Creating and Interpolating a Custom Pitch-table . . . . .	9 - 6
Alternate tunings for the System Pitch-table . . . . .	9 - 6

### About Pitch-tables

Alternate pitch-tables enable you to chart new musical territories as well as explore ancient and ethnic tunings. In Western music, equal temperament has been the dominant tuning for the last one hundred and fifty years, and is really a musical compromise. In equal temperament, all intervals are equally out of tune. However, this compromise is what allows our music to remain relatively in tune as we modulate from one key to another.

Equal temperament evolved out of other systems of tuning — such as just intonation — where intervals in a scale are tuned perfectly. The difficulty with perfectly-tuned scales is that you can't modulate keys as universally as with equal temperament. Nonetheless, computer technology — keep in mind your VFX<sup>SD</sup> is in fact a computer — has made it easy to create and employ alternate pitch-tables.

Imagine starting a piece in equal temperament, modulating to Pythagorean, then Werckmeister, then 19 tone, and back to equal temperament, simply by changing Programs. Sound interesting? Then the following section can help you on your way.

You select the pitch-table for each voice on the Pitch Page. The options are:

- **SYSTEM** — This is the "global" or keyboard-wide pitch-table. As it comes out of the box, the VFX<sup>SD</sup>'s System pitch-table defaults to 12-tone equal-temperament tuning (standard tuning). However, you can copy a custom pitch-table into the system for use by all your programs. The parameter for changing the system pitch-table is on the Master page. More on this feature a bit later.
- **ALL-C4** — No pitch tracking — all notes tuned to C4 (middle C).
- **CUSTOM** — each program in the VFX<sup>SD</sup> can have its own "user-definable" (that is, you create it) pitch-table. When you create a custom pitch-table the VFX<sup>SD</sup> will remove voices 5 and 6 from the program to create space for the pitch-table. Bear this in mind when creating a custom pitch-table — it could adversely affect the program if voices 5 or 6 are important parts of the sound.

### How to Create a Custom Pitch-table

- Select a program into which you want to write a custom pitch-table.
- Press **Program Control**. The display shows the Program Control page:

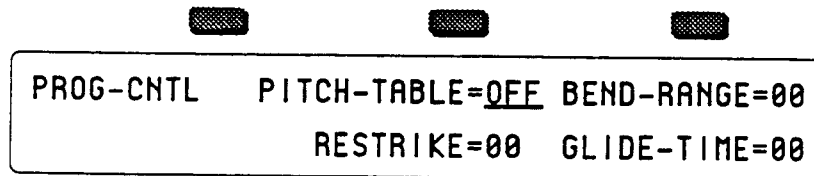

```

PROG-CNTL  PITCH-TABLE=OFF  BEND-RANGE=00
              RESTRIKE=00  GLIDE-TIME=00
  
```

- Make sure **PITCH-TABLE=OFF** is underlined.
- Press the up arrow button. The display reads:

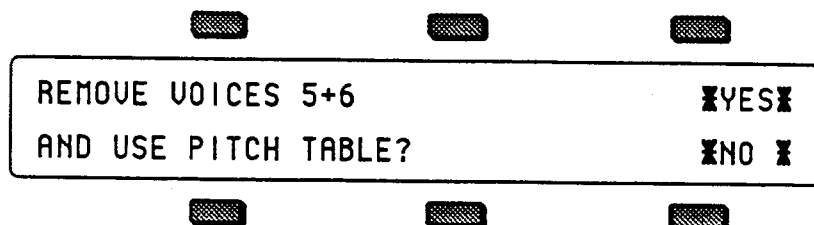

```

REMOVE VOICES 5+6                                XYESX
AND USE PITCH TABLE?                            XNO X
  
```

As mentioned above, whenever you create a custom pitch-table, the VFX<sup>SD</sup> will delete voices 5 and 6, and use the memory normally occupied by those parameters to store the pitch-table.

- Respond **\*YES\*** to REMOVE VOICES 5+6. This takes you to the Select Voice Page, which now shows the words EDIT PITCH-TABLE where voices 5 and 6 once were.

We have just created a custom pitch-table with variable pitch values for each key. Keep in mind that the custom pitch-table will sound the same as the normal one until you *edit* it. We will do this a bit later.

When you create a pitch-table and start editing it, you are in the edit buffer (the Compare light is on), and all edits will affect the data in the edit buffer, and not the program's memory. If you use the copy function while the compare light is on, the VFX<sup>SD</sup> will copy the data in the edit buffer, and not program's memory.

First, we need to select which of the four remaining voices will use the custom pitch-table.

- Double-click its soft button to solo the first voice on the Select Voice Page:

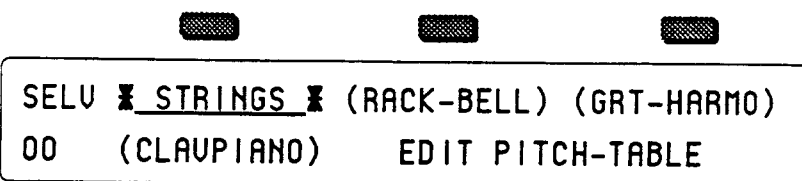

```

SELV X STRINGS X (RACK-BELL) (GRT-HARMO)
00 (CLAUPIANO) EDIT PITCH-TABLE
  
```

- Press **Pitch**. This takes us to the PITCH Page.

- Select the pitch-table parameter in the display and set it to PITCH-TABLE=CUSTOM.

Voice #1 is now set to play the custom pitch-table. This will enable you to hear any edits you make to the custom pitch-table.

Each voice in a program can be assigned to play either the System, no-pitch, or custom pitch-table. For example, Voice #1 can play the System pitch-table; Voice #2, a custom pitch-table; voices 3 and 4, No-pitch (C notes across the keyboard).

### Editing a Custom Pitch-table

As mentioned earlier, until you *edit* the custom pitch-table — change the default note assignments — the custom pitch-table will sound the same as a normal pitch-table. To edit a custom pitch-table:

- On the Select Voice page, press either of the soft buttons beneath EDIT PITCH-TABLE. This takes us to the EDIT PITCH-TABLE Page.

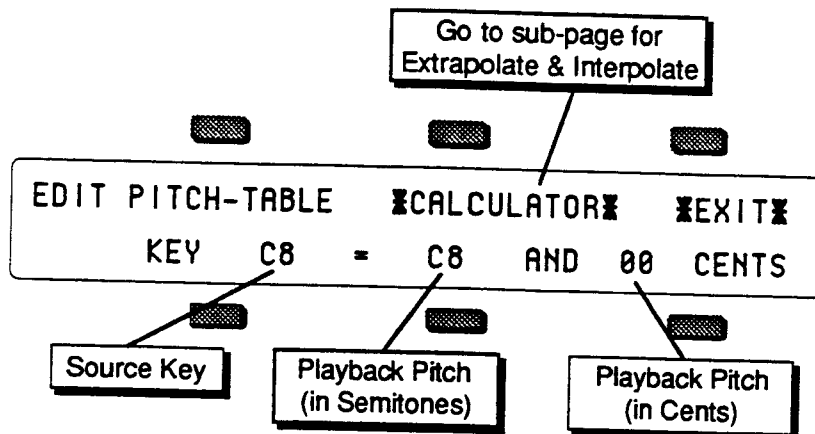

For every source key on the lower left, you can see and edit the pitch of that key.

The source key can be thought of as the physical location of the key on the keyboard. The playback pitch can be the same as the source key — as shown in the display — or it can be any pitch from A0 to C8. The range of the fine tuning is 00 to 99 cents. This enables you to create micro-tunings and other alternate tunings. First, let's get a feel for the relationship between the source key and the playback pitch.

- Make sure the KEY (source key) location is underlined.
- Play C4 (middle C) on the keyboard, or use the data entry controls to select C4 as the source key.
- Underline the playback pitch, in this case, C4.
- Use the up arrow button and change C4 (playback pitch) to C4+.
- Underline 00 CENTS. Use the data entry controls to change the value to 50 CENTS. The display reads:

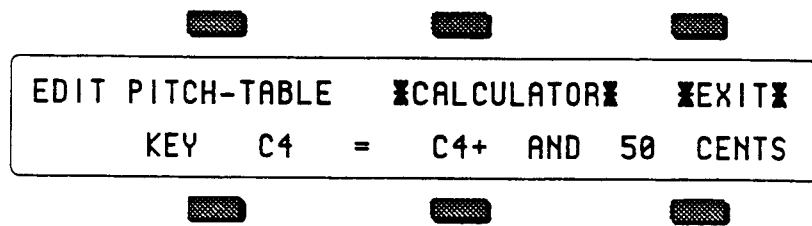

C4 now plays back at C4+ and 50 Cents, one and one half semitones higher than normal. Try selecting other source keys, and then changing their playback pitches to any values you like. This is how we edit the custom pitch table.

- Press \*EXIT\* to return to the Select Voice page.

### Removing a Custom Pitch-table

If a program contains a custom pitch-table and you wish to remove it (thus restoring voices 5 and 6) you can do so from the Program Control page:

To remove a custom pitch-table:

- Press *Program Control*.
- Underline PITCH-TABLE=ON.
- Press the down arrow button.
- The VFX<sup>SD</sup> will ask ERASE CURRENT PITCH TABLE?
- Press \*YES\*. You are returned to the Select Voice Page, the custom pitch-table is gone, and voices 5 and 6 are reset to the default voice.

You are now free to create a new custom pitch-table in your current program.

Now that you understand the relationship between the source key, playback pitch, and fine tuning in a custom pitch-table, let's start over. This time we'll work with an ancient tuning system, called Pythagorean. Then, we'll work with the VFX<sup>SD</sup> built-in pitch-table calculator, and two new procedures: Extrapolation and Interpolation.

### Creating and Extrapolating a Custom Pitch-table

The EXTRAPOLATE command takes the pitch-table relationships from within a key range and duplicates those relationships outside that range.

- If you have a custom pitch-table from the previous exercise, remove as shown above.
- Select a program into which you want to write a custom pitch-table.
- Press *Program Control*. This takes us to the Program Control Page.
- Set the pitch-table parameter to PITCH-TABLE=ON.
- Respond \*YES\* to REMOVE VOICES 5+6. This takes us to the Select Voice Page.
- Select a voice into which you want to write a custom pitch-table.
- Press *Pitch*.
- Select PITCH-TABLE=CUSTOM.
- Press *Select Voice* to return to the Select Voice Page.
- Press either of the soft buttons beneath EDIT PITCH-TABLE. This takes us to the EDIT PITCH-TABLE Page.
- The display shows the source key and playback pitch as described earlier.
- To set up one octave of a Pythagorean scale, change the source keys, playback pitches, and cents, one note at a time, from C4 to C5 — to the following values:

<u>Source Key</u>	<u>Playback Pitch</u>	<u>Cents</u>
C4	C4	00
C4+	C4+	17
D4	D4	04
D4+	D4+	01
E4	E4	08
F4	E4	98
F4+	F4+	12
G4	G4	02
G4+	G4+	14
A4	A4	06
A4+	A4	98
B4	B4	10
C5	C5	00

You can manually edit your custom pitch-table across the remaining octaves of the keyboard. Or you can use the Calculator in the VFX<sup>SD</sup> to do this for you.

- Press \*CALCULATOR\*. The display reads something like this:

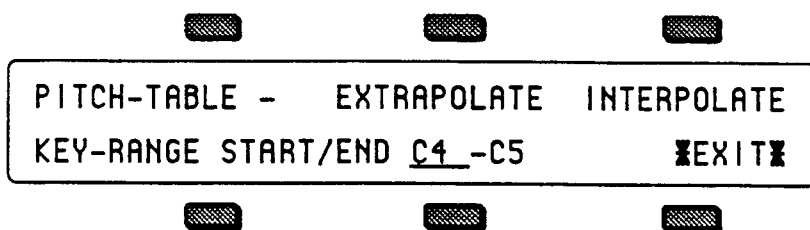

The KEYRANGE defines the area of the keyboard that the VFX<sup>SD</sup> will use as a reference by which to make its calculations.

To set the key-range:

- The START key (the first of the two key numbers shown) should be underlined. If not, press the soft button beneath it to select it. Now, play C4 (middle C) on the keyboard. The underline jumps to the END key.
- The END key should now be underlined. Play C5 on the keyboard. The parameter should read: KEY-RANGE START/END C4 - C5. You have defined the key range whose pitch intervals you want to duplicate over the entire keyboard.

Note that you can also set the start and end keys using the data entry controls, and press the soft button beneath them to toggle back and forth.

We began editing our pitch-table with note C4 and ended our editing with C5. This is key-range for this particular pitch-table. Extrapolate will take the intervals between the notes in our one-octave custom pitch-table and apply them to the rest of the keyboard, resulting in a Pythagorean tuning covering the entire keyboard.

- Press EXTRAPOLATE. The display briefly reads PITCH-TABLE \*CALCULATOR\*, then returns with the Pythagorean temperament across the whole keyboard.

At this point you might want save this pitch-table by writing the program into memory as described in Section 7. Or, you can use the Copy function to copy it into another Program, or even into the system, for use by all your programs. See Copy Function.

### Creating and Interpolating a Custom Pitch-table

INTERPOLATE takes the interval between two notes on the keyboard and divides all the keys in between into equally-spaced fractions of that interval.

As an example, lets make the entire 5-octave keyboard of the VFX<sup>SD</sup> span just one octave in pitch from the lowest key to the highest.

- Using the procedure described earlier, create a custom pitch-table, and select PITCH-TABLE=CUSTOM on the Pitch page.
- On the Select Voice Page, press the soft button for EDIT PITCH-TABLE.
- Set KEY C2 = C3 AND 00 CENTS. Next, set KEY C7 = C4 AND 00 CENTS.

We've just established an interval of octave between C2 and C7.

- Press \*CALCULATOR\*
- Set the key range to KEY-RANGE START/END C2 -C7.
- Press INTERPOLATE.

The VFX<sup>SD</sup> has just Interpolated the octave (C3 to C4) and divided it equally across the 61 note keyboard, so we now have a 60 step octave.

**Warning:** You must save the program containing your custom pitch-table, or copy the custom pitch-table into the system, or you will lose it as soon as you edit another sound.

### Alternate tunings for the System Pitch-table

As an added feature, the System Pitch-table itself is user-definable. For instance, if you want to hear what other programs sound like using the custom pitch-table from a program, you can redefine the System pitch-table. Or, if your main tuning is "just intonation," then it might be convenient for you to use this or some other alternate tuning as your System tuning.

To install an alternate tuning into the System pitch-table:

- Select a program which contains a custom pitch-table.
- Press *Select Voice*.
- Press soft button beneath EDIT PITCH-TABLE.
- Press the *Copy* button. The display reads:

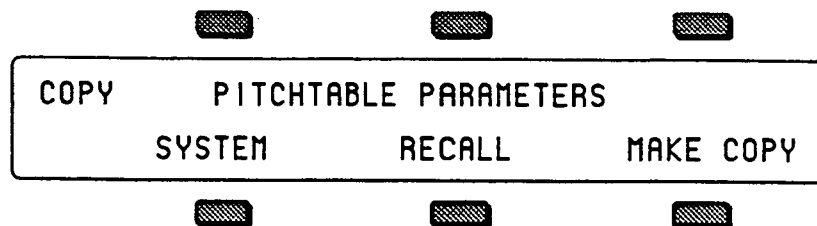



- Press the soft button beneath SYSTEM. The display briefly reads COPY TO SYSTEM PITCH-TABLE, and the custom pitchtable is installed into the VFX<sup>SD</sup> operating system where it is available for use by any program.
- Press *Master* twice to reach the second sub-page of the Master page.

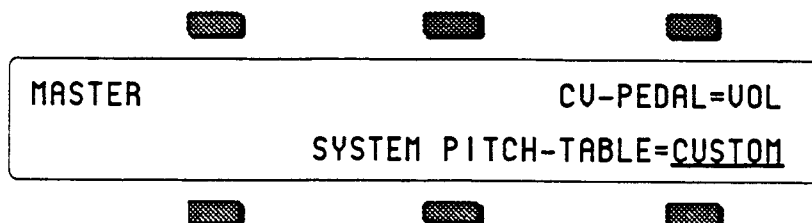

- Note that the SYSTEM PITCH-TABLE parameter has been set to CUSTOM. Now all programs whose voices are set to use the system pitch-table (which is most programs) will use the custom pitch-table.

To return all programs to standard equi-tempered tuning, set the SYSTEM PITCH-TABLE parameter back to NORMAL. Switching back to CUSTOM will restore your custom System pitch-table. You can switch back and forth as often as you wish. You can also try installing other custom pitch-tables in the System, but the System pitch-table can only contain one custom pitch-table at a time.



## Section 10 — Using the Copy Functions

The Copy page provides programming utility functions for:

- copying entire pages of parameter data at once while programming voices
- copying complete voices, effects, or programs
- changing the system pitch table

About the Copy Functions . . . . .	10 - 1
Copy contexts and MAKE COPY . . . . .	10 - 2
RECALL . . . . .	10 - 3
Special Recall Functions . . . . .	10 - 3
Special Copy Operations	
DEFAULT . . . . .	10 - 4
SYSTEM . . . . .	10 - 5
Useful Applications of the Copy Functions	
Copying an effect from one program to another . . . . .	10 - 5
Copying all parameters from one voice to another . . . . .	10 - 5
Copying a complete program to a new location . . . . .	10 - 6
Making a copy of the compare buffer . . . . .	10 - 6
Collecting parts from several sources into the copy buffer . . . . .	10 - 6

### About the Copy Functions

When programming synthesizers, it is often desirable to be able to make changes to some component of a sound and then to transfer the newly modified component to another part of the same voice or program, or even to use it in a different program. Before the development of the VFX and VFX<sup>SD</sup>, this was not easy to accomplish without the aid of external computer-based editors. The Copy page of the VFX<sup>SD</sup> provides several useful functions which facilitate copying components from one place to another. The components which can be copied may be all of the parameters on a page or in a voice, or even an entire program. The copy function can be used to move programs from one location to another, using a procedure described later in this section.

Pressing the *Copy* button will display the Copy page menu. Pressing *Copy* while the Copy page is displayed will return you to the last parameter page that was selected.

*The copy context determines which parameters will be affected by the functions on the page.*

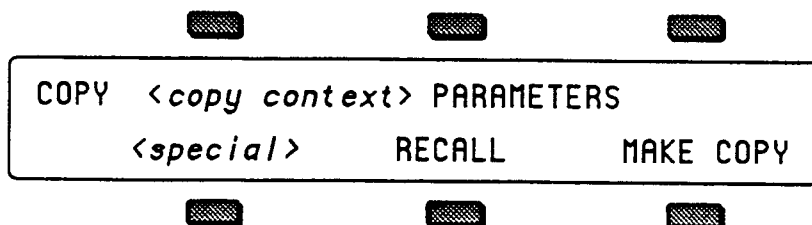

The top line of the display indicates the currently selected *copy context*. The copy context is determined by the type of page that was selected just before you pressed *Copy* to enter the Copy page.

This simple example shows how you can set the copy context.

- Press *Wave* to display the Wave page.
- Press *Copy*. The copy context will show WAVE PAGE PARAMETERS.
- Press *Copy* again. You will be returned to the Wave page.

There is a well-defined group of copy contexts that are available for your use. The copy context is set whenever you select pages from within this group. The following table shows the copy context that is automatically set whenever particular pages are displayed.

<i>Prior page...</i>	<i>Copy context</i>	<i>What gets copied...</i>
Wave	WAVE PAGE	all Wave page parameters
LFO	ALL LFO	all LFO page parameters
Pitch	PITCH PAGE	all Pitch page parameters
Pitch Mod	PITCH MOD	all Pitch Mod page parameters
ENV1..3	ENVELOPE-#	all parameters for one envelope
Filter 1 or 2	FILTER-#	all parameters for a single filter
Mod Mixer	MOD MIXER	all Mixer/Shaper page parameters
Output	OUTPUT	all Output page parameters
Effects	EFFECTS	all Effects page parameters
Select Voice	ALL VOICE	all parameters for selected voice
Edit Pitch Table	PITCHTABLE	one complete pitchtable (voices 5/6)
Program Control	PROGRAM	
Sounds/Program Bank	PROGRAM	all parameters for selected program

Note: In order to use the copy functions successfully, it is important to understand how to control the copy context, and what is being copied.

*The copy buffer is an invisible portion of memory used to hold the most recently copied parameters until they are recalled.*

The contents of the copy buffer are completely independent of the compare buffer used in editing programs. You can make copies into the copy buffer without affecting the data in the compare buffer. Recalling data from the copy buffer always changes only the compare buffer. The copy buffer can contain anything from a single page of parameter values up to an entire program which includes six voices and an effect. The copy buffer is *context-sensitive*, meaning that your options are controlled by your previous actions.

The bottom line of the display shows the available operations which can be performed on the page.

## MAKE COPY

Based on the current copy context, this command will copy a set of parameters into the copy buffer. The copy buffer is a separate buffer into which the copy utility will copy data without affecting the current edit program in the compare buffer. Remember that MAKE COPY has no effect on the compare buffer or the selected program or voice.

## RECALL

This command will copy parameters back from the copy buffer into the compare buffer where the edit program resides, again according to the copy context. Pressing the soft button below RECALL causes the indicated data set to be copied, and the display returns to the Copy page.

The RECALL function always copies data into the compare buffer. If the compare buffer is selected (i.e. the *Compare* LED is on) at the time you perform a recall, then the data is added to the edited program in the compare buffer. If the compare buffer is not selected then the compare buffer is loaded with the currently selected primary program before the recall is completed. The compare buffer is always selected after a recall.

If Group Edit is active when pages of voice parameters are recalled, then the recall will affect all of the voices in the group. The data being recalled will be written into all of the grouped voices in the compare buffer at the same time. For example, you could make a copy of an envelope page from one voice and then recall it into a group of voices in one step. Group Edit has no effect when recalling effects, complete voices, pitch tables, or complete programs.

### Special Recall Functions

There are several exceptions to the normal pattern of operation in the RECALL function. The first exceptions occur with the Envelope and Filter contexts. When the copy context is set to any of the Filter or Envelope settings, pressing RECALL will display an additional page which allows you to select the source and destination pages for the parameter transfer. This allows you to copy information between different envelopes and filters.

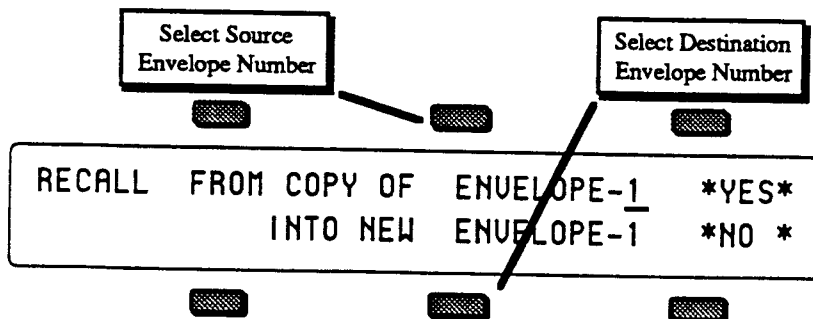

The sample screen shown above illustrates the RECALL sub-page for the ENVELOPE context. The Source Envelope number controls which envelope in the copy buffer will be used by the recall, and the Destination Envelope number determines which envelope in the compare buffer will be replaced with the new data being recalled. The default settings are always the same number for source and destination. If you want to copy across from one envelope to another, you must set the source and destination envelope numbers accordingly. The RECALL sub-page for the FILTER context is similar in appearance and function.

Remember that the copy buffer always contains copies of each of the three envelopes and two filters, regardless whether you last used an envelope, filter, voice, or program copy function.

Another exception occurs in the PROGRAM context. Pressing RECALL from this context will take you directly to the Write page. The compare buffer is loaded

with the same information as the copy buffer whenever you recall an entire program, and you are ready to save the program in a new location.

The system will alert you if you try to recall into a context different than the last copy action that was performed. This prevents you from mistakenly recalling a fragmented voice, program or pitch-table.

**Special Copy Operations**

There are also some special command options that appear in the display (above the lower left soft button) for certain copy contexts.

**DEFAULT**

There are some copy contexts which provide the option of recalling default parameter settings automatically. When this option is available, the DEFAULT command appears in the lower left part of the display.

- For the ALL VOICE parameter context:

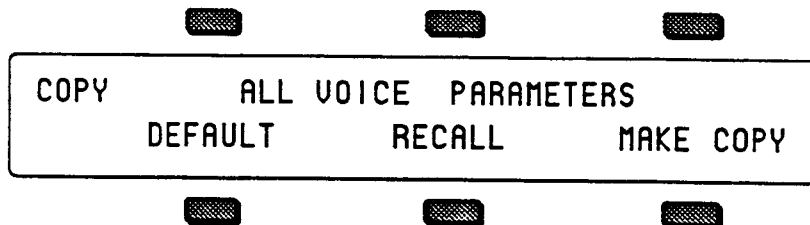

The DEFAULT command will make a copy of the default voice into the copy buffer and then automatically recall it into the currently selected voice in the compare buffer, as if you had performed the steps yourself. This allows you to easily put the voice into a standard configuration, which is often useful when creating new programs.

- For the ENVELOPE-1, -2, and -3 parameter contexts:

The DEFAULT command also appears with the ENVELOPE-# context. Pressing the soft button below the command displays a sub-page which will allow you to select from a group of standard preset envelope types which can be recalled into the current envelope. This is particularly useful when setting up typical envelopes as starting points when you are creating new voices.

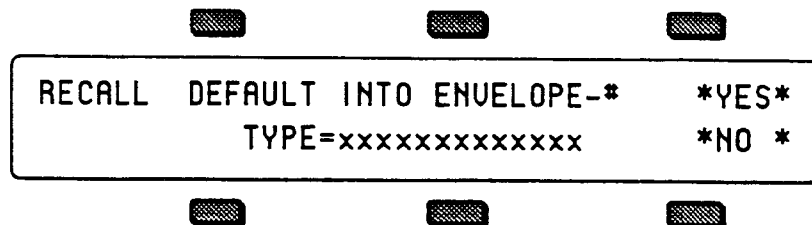

Select the default envelope type using the data entry slider or the up/down arrows and press YES if you wish to install the selected envelope type into the envelope number shown on the upper line of the display. Press NO to return to the Copy page without performing any action.

## SYSTEM

For the PITCHTABLE parameter context only:

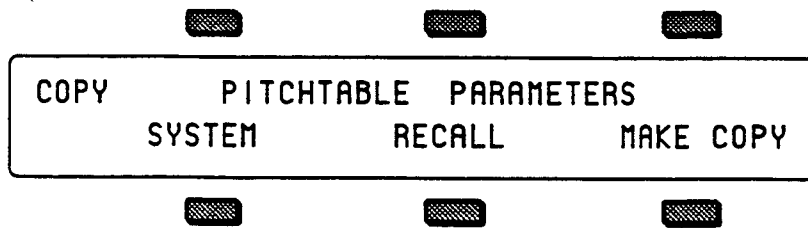

When entered from the Edit Pitch-Table pages, the Copy page shows the SYSTEM command on the lower left part of the display. This command will copy the pitch-table directly from the currently program, or from the compare buffer if the Compare LED is on, into the system pitch table. It is not necessary to use the MAKE COPY command in this case. Using this command will automatically set the SYSTEM PITCH-TABLE parameter on the Master page to CUSTOM, thereby selecting the newly installed pitch table for use as the system pitch table. Refer to the Master page and Using Pitch Tables sections for more information on the system pitch table.

## Some useful applications of the copy functions

### Copying an effect from one program to another

- Press *Sounds* and select the program whose effect you wish to copy.
- Press *Effect* in the Programming section to display the Program Effect page for this program.
- Press *Copy*. The copy context will show EFFECTS PARAMETERS.
- Press the soft button below the MAKE COPY option to copy the Effect page parameters into the copy buffer.
- Select the program into which you wish to copy the effect. If the sound you are working on is in the compare buffer, make sure that the Compare LED is on.
- Press *Effect* in the Programming section to redisplay the Program Effect page.
- Press *Copy*. You will be returned to the Copy page with the EFFECTS context.
- Press the soft button below the RECALL option to recall the effect from the copy buffer.
- Press *Copy* again. You will be returned to the Effect page. Note that the effect that you previously copied has now replaced the old effect. Remember to write the program if you wish to keep the change.
- You can use the same process to recall an effect into a sequence, song or preset.

### Copying all parameters from one voice to another

When the Copy page is entered from the Select Voice page, the copy context is set to ALL VOICE PARAMETERS. In this context, the values of all voice parameters for the currently selected voice are transferred to or from the copy buffer. Using this method, you can easily copy voices within a program or from one program to another.

- Press *Select Voice* to display the Select Voice page and to set the copy context. Make sure that the voice which you wish to copy is selected.
- Press *Copy*. The copy context will show ALL VOICE PARAMETERS.

- Press the soft button below the MAKE COPY option to copy the voice into the copy buffer.
- Press *Copy* again. You will be returned to the Select Voice page.
- Select the voice you wish to replace with the voice you just copied.
- Press *Copy* again. You will be returned to the Copy page.
- Press the soft button below the RECALL option to recall the voice from the copy buffer.
- Press *Copy* again. You will be returned to the Select Voice page. Note that the voice you previously copied has now replaced the old voice.

### Copying a complete program to a new location

It is easy to copy programs from one location to another using the copy and recall functions. Simply follow this procedure:

- Press *Sounds* and select the program that you wish to copy. This will automatically set the copy context to PROGRAM PARAMETERS.
- Press *Copy* to display the Copy page.
- Press the soft button below the MAKE COPY option to copy the program into the copy buffer. The program will be copied into the copy buffer, and the Copy page will be redisplayed.
- Press the soft button below the RECALL option to recall the program from the copy buffer into the compare buffer. The Write page will be displayed automatically.
- Using the normal techniques for writing programs, select the destination in which you wish to locate the copy (refer to the section describing the Write page if you are unsure how to proceed).

### Making a copy of the compare buffer

If you wish to make a copy of the complete compare buffer before making some experimental edits that you are unsure of, then use the following procedure to make a backup copy of the current compare or edit buffer:

- Set the copy context to the Program context by pressing *Program Control* or *Sounds*.
- Make sure that the *Compare* LED is on, and that you are hearing the edit program of which you wish to make a copy (*press Compare* if not).
- Press *Copy* and make sure that the copy context is PROGRAM PARAMETERS.
- Press the soft button below the MAKE COPY option to copy the compare buffer into the copy buffer.

### Collecting parts from several sources into the copy buffer

While you can only make a single copy of an entire voice or program at one time, it is possible to make consecutive copies of multiple pages of parameters before recalling the data you have copied. These pages can even be taken from different voices or different programs.

For example, using the normal MAKE COPY process, you can make copies of one or more envelope pages, followed by an LFO page and a wave page. A single copy of *each* of these pages is saved into the copy buffer. You can then start recalling the pages you want into the compare buffer using the normal RECALL procedure described above. The data you copied will remain intact until you copy a complete voice or program, which will replace the contents of the copy buffer.



## Section 11 — Storage Functions

The Storage page provides data storage functions that enable you to:

- save and load Program, Preset, Sequencer and System data to disk,
- transfer Program and/or Preset data to or from VFX-compatible cartridges, and
- transmit dumps containing Programs, Presets and Sequencer data via MIDI system exclusive messages.

Disk Storage	
VFX <sup>SD</sup> Disk File Types . . . . .	11 - 2
Disk Capacity — Bytes, Blocks and Files . . . . .	11 - 3
File Banks . . . . .	11 - 4
VFX <sup>SD</sup> Disk Functions . . . . .	11 - 4
Format . . . . .	11 - 5
Copy . . . . .	11 - 6
Save . . . . .	11 - 7
Load . . . . .	11 - 10
Delete . . . . .	11 - 12
MIDI Sys-Ex	
Sending Programs . . . . .	11 - 13
Sending Presets, Sequencer Data, and All Data . . . . .	11 - 14
Cartridge	
Copying Programs from Internal to Cartridge . . . . .	11 - 15
Copying Programs from Cartridge to Internal . . . . .	11 - 16
Copying Presets from Cartridge to Internal . . . . .	11 - 16
Copying Presets from Internal to Cartridge . . . . .	11 - 17
Copying Both from Internal to Cartridge . . . . .	11 - 18
Copying Both from Cartridge to Internal . . . . .	11 - 19
MIDI System Exclusive Recorder . . . . .	
Saving Sys-Ex Data from an External Device . . . . .	11 - 21
Loading Sys-Ex Data from Disk to an External Device . . . . .	11 - 23
Additional Sys-Ex Recorder Notes . . . . .	11 - 24
VFX <sup>SD</sup> Disk Error Messages . . . . .	11 - 25

The Storage Page presents a series of menus containing command options which are selected by using the soft buttons.

- Pressing *Storage* will always display the Storage page.

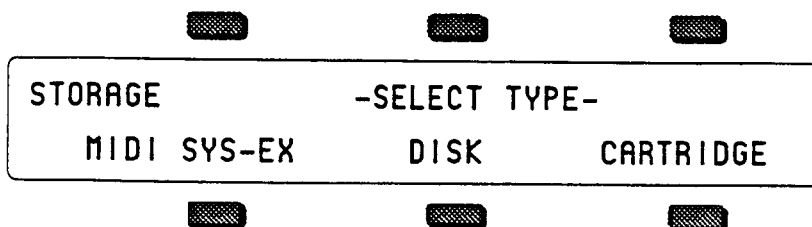

From the Storage page you can select which one of the three forms of data storage you wish to use — MIDI Sys-Ex messages, Disk or Cartridge storage.

Since Disk storage is the most convenient and commonly used form of storage, we'll cover that first.

## Disk Storage — Using the Disk Drive to Save and Load Data

The VFX<sup>SD</sup>'s built-in disk drive can be used to store all your program, preset and sequencer data, as well as System Exclusive messages from other MIDI devices. The VFX<sup>SD</sup> uses a double-sided drive, which can store over 800 Kilobytes of data per disk. You should use Double-Sided Double-Density (DSDD) 3.5" micro-floppy disks for reliable disk operation. The disks are enclosed in a protective plastic carrier with an automatic shutter to protect the diskette from physical damage. It is important not to alter this carrier in any way.

The 3.5" disks have a sliding write-protection tab so that you can protect your own sounds and sequences against accidental erasure. Sliding the write-protection tab in the lower left corner of the disk so that the window is closed will allow you to store information on the disk. Sliding the tab so that the window is open will protect the disk against being accidentally reformatted or having files deleted.

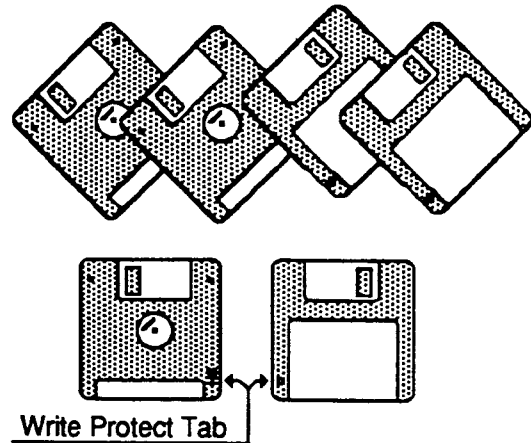

Disks are a magnetic storage medium, and should be treated with the same care you'd give important audio tapes. You should keep your disks and the disk drive clean and free of dust, dirt, liquids, etc. Never put anything other than a disk in the disk drive. Do not expose disks to extremes of temperature or to strong magnetic fields. Also, never eject a disk while the drive is operating (the disk drive light is on).

### VFX<sup>SD</sup> Disk File Types

The VFX<sup>SD</sup> disk storage system has been designed to allow maximum flexibility in saving, loading and organizing your sound and sequence data. Consequently, for each type of data there are several different types of files that can be saved:

#### Programs:

- 1-PROGRAM file — contains a single VFX<sup>SD</sup> program.
- 6-PROGRAM file — contains a bank of 6 VFX<sup>SD</sup> programs, as displayed on the Program Bank pages 0-9. This file type lets you organize programs into groups of six which can be saved and loaded back into any bank you choose.
- 30-PROGRAM file — contains 30 VFX<sup>SD</sup> programs, saved from either the lower half of the program memory (Banks 0-4) or the upper half (Banks 5-9). A 30-Program file can be loaded into either the upper or lower half, making it easy to shuffle program memory.
- 60-PROGRAM file — contains the entire program memory (Banks 0-9).

#### Presets:

- 1-PRESET file — contains a single preset.
- 10-PRESET file — contains one bank of 10 VFX<sup>SD</sup> presets, saved from either bank A or B of the internal preset memory.
- 20-PRESET file — contains the entire preset memory, banks A and B.

**Sequence/Song:**

- 1-SEQ/SONG file — contains a single VFX<sup>SD</sup> sequence or song.
- 30-SEQ/SONGS file — contains 30 VFX<sup>SD</sup> sequencer locations, saved from either the lower half of the sequencer memory (Banks 0-4) or the upper half (Banks 5-9). A 30-Seq/song file can be loaded into either the upper or lower half.
- 60-SEQ/SONGS file — contains the entire sequencer memory (Banks 0-9).

Whenever you save a 30 or 60 Seq/Song file to disk you will be asked whether you want to also save internal programs (either 30 or the entire 60) in the same file along with the sequencer data. This lets you keep the sequences and their appropriate programs together when reloading the data.

**MIDI System Exclusive data:**

In addition to the above types of VFX<sup>SD</sup> data, you can use the disk drive to save system exclusive data from other MIDI devices. The VFX<sup>SD</sup> can thus serve as the "librarian" for your other MIDI gear. This function is covered at the end of this section.

**System Files:**

There are two additional types of files which have to do with system operation:

- SYSTEM-SET-UP — System set-up files let you save the system, or "global" parameters, those contained on the Master and MIDI pages, so that you can save and re-load a new system configuration in seconds. This is handy if you use the VFX<sup>SD</sup> in a number of different applications which require different settings for MIDI mode, MIDI base channel, master tuning, etc.
- SEQUENCER OS — The computer program which controls the VFX<sup>SD</sup> sequencer (the sequencer *Operating System*, or O.S.) is contained in RAM (random access memory) and can be updated from disk as upgrades become available. The disk that came with your VFX<sup>SD</sup> contains the current Sequencer O.S. Sequencer upgrades will be available from your authorized ENSONIQ dealer as they are released. Also, if the VFX<sup>SD</sup> sequencer memory should ever become corrupted, you might be prompted to reload the Sequencer O.S. from disk with the message SEQUENCER OS MUST BE LOADED. The Sequencer O.S. is loaded like any other file from the Load File page, covered later in this section.

**Disk Capacity — Bytes, Blocks and Files**

Each double-sided 3.5" micro-floppy disk will hold 800k bytes of VFX<sup>SD</sup> data, which translates into about 1600 *Blocks*. (A Block is a handy unit which the VFX<sup>SD</sup> uses to measure disk memory — 1 Block=512 bytes; 2 Blocks=1k bytes.)

VFX<sup>SD</sup> disk files vary in size — how many will fit on a disk depends on the number and size of the files. Whenever you are on the DISK LOAD page the display shows the size in blocks of each file on the disk. When you are on the DISK SAVE page the display shows the number of free blocks available on the disk in the drive.

There are limits to the number of files on a disk:

- Each disk can hold a *maximum* of 156 files.
- A disk can hold up to 60 files of any one file type, but not more than the total of 156 files of all types for a single disk.

## File Banks

A unique feature of VFX<sup>SD</sup> which we call *File Banks* allows you to quickly and easily locate the disk file you want to load or delete. File Banks provide a graphic way for you to organize and view disk files, and eliminate the need to scroll through long lists of files.

Whenever loading or deleting a file, after you have selected the file type you want, pressing the 10 Bank buttons beneath the display will cause all the disk files of that type to be shown in groups of six, just like sound or sequence banks. Pressing the soft button next to a file installs that file as the one to be loaded, deleted etc.

When saving data to disk you can, if you wish, specify a particular file bank location for that file to be displayed in. This gives you a high degree of control over how your disk files are organized and displayed.

## VFX<sup>SD</sup> Disk Functions

The VFX<sup>SD</sup>'s disk functions are all handled from the Storage page. Press the *Storage* button to get to this page, then press the soft button beneath DISK. When you select DISK from the Storage page, the display shows the disk storage menu:

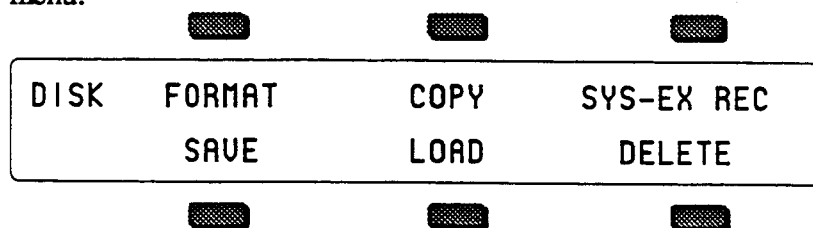

From here you select which of the 6 disk functions you want:

- **FORMAT** — This formats a blank disk for use with the VFX<sup>SD</sup>.
- **COPY** — This allows you to make a backup copy of an entire VFX<sup>SD</sup> disk.
- **SYS-EX REC** — MIDI System Exclusive recorder. This function allows you to receive, and save to disk, programs, sequences and other data from external MIDI devices.
- **SAVE** — save to disk Sequencer, Program, Preset, or System Set-up files.
- **LOAD** — load from disk Sequencer, Program, Preset, System Set-up files; also load System Exclusive data for transmission to a remote MIDI device.
- **DELETE** — allows you to delete (or remove) any file from the disk.

**FORMAT — Formatting a Blank Disk**

Before it can be used by the VFX<sup>SD</sup> to store data, a disk must be formatted. Formatting puts information on the disk which the VFX<sup>SD</sup> needs to read and write files. In addition to formatting a blank disk, the Format procedure can be used to reformat a disk which has been used with some other device, such as a personal computer or another musical instrument. Note that any data (of whatever type) on a disk will be lost when the disk is formatted by the VFX<sup>SD</sup>.

To Format a blank disk:

- Insert a blank, Double-Sided Double-Density 3.5" micro-floppy disk into the disk drive, with the label-side facing up, and the metal shutter facing away from you. Make sure the plastic write-protect tab is in the closed position (no light showing through the window).
- Press *Storage*.
- Press DISK. The Disk Storage menu appears (as shown earlier).
- Press FORMAT.
- The display shows:

```

    FORMAT DISK                               *YES*
    ALL DISK FILES WILL BE ERASED             *NO *
  
```

- Press \*YES\* to proceed. (Pressing \*NO\* will return you to the Disk Storage page with no harm done.)
- While the VFX<sup>SD</sup> is formatting the disk the display reads "FORMATTING DISK..." The formatting process takes about 80 seconds.
- When the formatting is done, the display reads "DISK FORMATTED SUCCESSFULLY", and then you are returned to the Storage page. The disk is ready to accept program, preset, sequencer or system data.

**FORMAT DISK Error Messages:**

There are a number of messages you might encounter while formatting a disk:

- DISK DRIVE NOT READY — No disk in the drive.
- DISK FORMAT FAILURE -- DISK IS UNUSABLE. This indicates a defective disk. If you get this message we advise that you throw out the disk in question. Try again with another disk.
- DISK WRITE-PROTECTED — The plastic write-protect tab in the lower-left corner of the disk must be closed (so you can't see through the hole) before anything can be written to the disk. Close the write-protect tab and try again.

**COPY — Making a Backup Copy of a Disk**

The COPY function lets you duplicate the contents of one entire disk (the *source disk*) on another disk (the *destination disk*). It is a good practice to regularly back up your valuable data, including the Sequencer OS disk which came with the VFX<sup>SD</sup>, in this way.

**Warning:** This procedure uses the sequencer memory to temporarily hold the information while copying it between disks. Anything in the sequencer memory before you start will be erased. Save any important sequencer data before copying a disk.

To Make a Backup Copy of a Disk:

- Slide the plastic write-protect tab on the source disk — the original — so that the disk is write protected (you can see through the hole). This is an extra precaution to safeguard the data.
- Press *Storage* and then select DISK.
- Press COPY. The display shows SEQUENCER DATA WILL BE ERASED.
- Press \*YES\* (or press \*NO\* to cancel and save the data before proceeding.) The display shows:

<p style="margin: 0;">INSERT DESTINATION DISK</p> <p style="margin: 0;">ALL DISK FILES WILL BE ERASED</p>	<p style="margin: 0;">* OK *</p> <p style="margin: 0;">*QUIT*</p>
---	---

- Insert the destination disk (the copy) and press \*OK\*. If the destination disk is not formatted, the VFX<sup>SD</sup> will format it before proceeding.
- After a moment the VFX<sup>SD</sup> will ask INSERT SOURCE DISK. Insert the write-protected source disk (the original) and press \*OK\*.
- The VFX<sup>SD</sup> will load the data from the source disk into the sequencer memory, and then save it to the destination disk, asking you to insert the appropriate disks as it needs them. Each time, insert the proper disk and press \*OK\*. (Note that you can press \*QUIT\* at any time to abort the procedure.)
- The Copy disk procedure requires about nine disk swaps with the standard memory configuration; three with the optional memory expansion installed.
- Once the Copy procedure is successfully done, the display will read DISK COMMAND COMPLETED, and then return to the Storage page.

DISK COPY Error messages:

- **DISK WRITE-PROTECTED** — When asked for the Destination disk you inserted a Write-protected disk. The Destination Disk must have the Write-protect window closed.
- **DISK IS NOT SOURCE DISK** or **DISK IS NOT DESTINATION DISK** — You put the wrong disk in the drive when prompted for a certain disk. This is not fatal; it doesn't abort the Copy procedure. Just insert the asked-for disk and proceed.

**SAVE — Saving Data to Disk**

When you press SAVE from the Disk Storage menu, you will see the following display:

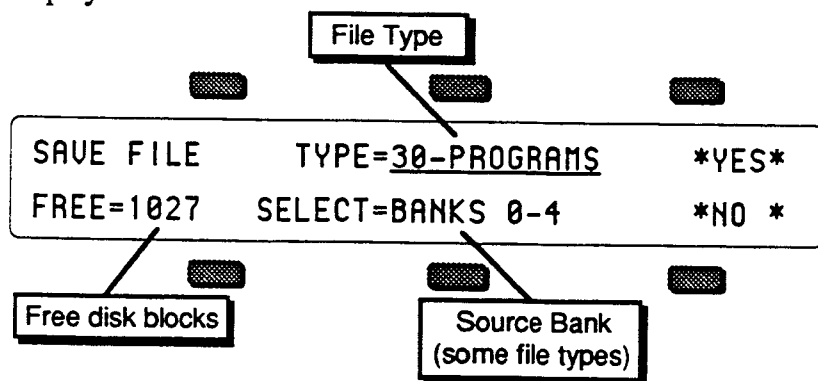

The display shows the *File Type*, the number of free blocks on the disk, and (for some file types) the *Source Bank*, i.e. which bank(s) you want to save.

To Save data to disk:

- Insert a formatted VFX<sup>SD</sup> disk into the disk drive.
- When saving 1-PROGRAM, 1-PRESET or 1-SEQ/SONG, first make sure the program, preset or sequencer location you want to save is selected.
- Press *Storage* to go to the Storage Page.
- Press DISK. The Disk Storage menu appears.
- Press SAVE. The Save File display appears as shown above. The file type is underlined.
- Select the file type you want to save from among the available types:

- |             |            |               |
|-------------|------------|---------------|
| 1-PROGRAM   | 1-PRESET   | 1-SEQ/SONG    |
| 6-PROGRAMS  | 10-PRESETS | 30-SEQ/SONGS  |
| 30-PROGRAMS | 20-PRESETS | 60-SEQ/SONGS  |
| 60-PROGRAMS |            | SYSTEM-SET-UP |

- Select a source bank (if applicable). For the file types 6-PROGRAMS, 30-PROGRAMS, 10-PRESETS and 30-SEQ/SONGS you will see a source bank beneath the file type, as shown above. This defaults to the current bank(s). If you want to save a different bank than what is showing, select this field and change it using the data entry controls.
- Press \*YES\*. The display shows:

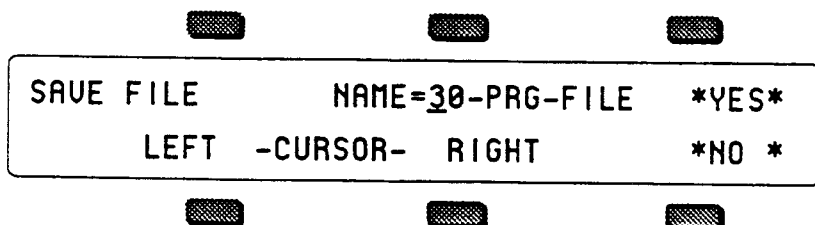

- Name the file with a name of your choice using the data entry controls and the two cursor soft buttons, labeled LEFT and RIGHT. (Or you can use the keyboard to select characters and move the cursor: see below.)
- Press \*YES\*. The display reads SAVING <FILENAME> while the data is being saved to disk. Or Press \*NO\* to cancel the procedure for any reason. (If





**Note:** If programs have been saved in a Sequencer file along with the sequencer data, when you later go to load the file, a **P** will flash on the display next to the file name when the file is displayed on the DISK LOAD page. When you answer **\*YES\*** to load the data, the VFX<sup>SD</sup> will load the programs automatically with the sequencer data. This will over-write the programs that are in the internal memory. You should always be sure that any programs you value are saved before loading sequencer files which contain programs.

### Specifying a File Bank Location when Saving a File

If you follow the save procedure exactly as described earlier (pressing **\*YES\*** after naming the file) the data will automatically be placed in the first empty file bank location for that file type, starting from the first location in Bank 0 and going up from there.

However, you can specify a particular file bank for the file to be placed in:

- Press **Storage**, and select **DISK**, then **SAVE**. The Save File display appears.
- Select the desired file type and then press **\*YES\***.
- Name the file with the name of your choice.
- Now you can press the bank buttons (0-9) to see the file banks, which show all the files of that type on the disk, six at a time. For example:

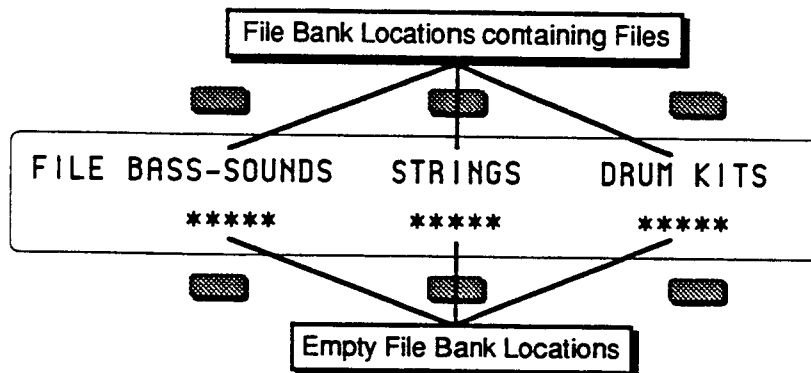

- File bank locations containing a file show the file name. Locations that show **\*\*\*\*\*** are empty and are available for saving files to.
- Press the soft button next to any empty file bank location, and the VFX<sup>SD</sup> will immediately save the file in that location. This lets you organize your files into banks of your choosing for easy access when loading them later.
- If there is a file with the same name already on the disk in a different file bank location, the VFX<sup>SD</sup> will ask **DELETE OLD VERSION?** If you press **\*YES\*** the VFX<sup>SD</sup> will delete the original file and save the new one in the new location. Use this to change the bank in which a file is saved.
- Note that when you simply want to update an existing file, but not change its file bank location, it is not necessary to specify the location. Just press **\*YES\*** after naming the file and answer **\*YES\*** to **DELETE OLD VERSION?**

**LOAD — Loading Data from Disk**

When you press LOAD from the Disk Storage menu, you will see the following display:

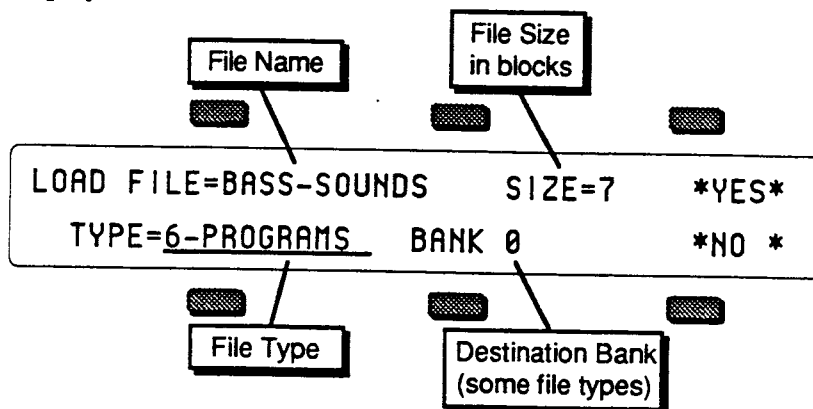

The display shows the *File Name* which identifies the file that will be loaded if you press \*YES\*; the *Size* of the file in Blocks; the *File Type* and (for some file types) the *Destination Bank*, i.e. which bank(s) to load the data into. Only files of the type selected will be shown in the Name field, or in file banks.

To Load a file from disk:

- Insert the disk containing the file data into the disk drive.
- Press *Storage* to go to the Storage Page.
- Press DISK. The Disk Storage menu appears.
- Press LOAD. The Load File display appears as shown above. The file type is underlined.
- Select the file type you want from among the 13 available types:

1-PROGRAM	1-PRESET	1-SEQ/SONG	SYS-EX DATA
6-PROGRAMS	10-PRESETS	30-SEQ/SONGS	SYSTEM-SET-UP
30-PROGRAMS	20-PRESETS	60-SEQ/SONGS	SEQUENCER-OS
60-PROGRAMS			

- Press the soft button above the file name and use the data entry controls to find the file you want. (Or you can use the File Banks to quickly locate the file without scrolling; see below.)
- Select a destination bank (if applicable). For the file types 6-PROGRAMS, 30-PROGRAMS, 10-PRESETS and 30-SEQ/SONGS you will see a destination, as shown above. This defaults to the same bank the file was originally saved from. If you want a different destination bank, select this field and change it using the data entry controls.
- Press \*YES\*. The display reads "LOADING FILE..." while the data is being loaded. Or Press \*NO\* to cancel the procedure for any reason.
- After the file is loaded, the VFX<sup>SD</sup> returns to the Load File page so that you can load any other files you may want.

Where the data ends up depends on the file type and (where applicable) the destination bank selected:

- 1-PROGRAM file — once loaded, the program is placed on the Write page, from which you can save it to any internal or cartridge location as detailed in Section 7.
- 6-PROGRAM file — the bank of 6 programs is loaded into the destination

- Bank (0...9) specified before pressing \*YES\*.
- 30-PROGRAM file — the 30 programs will be loaded into either the lower half of the program memory (Banks 0-4) or the upper half (Banks 5-9) as specified before pressing \*YES\*.
- 60-PROGRAM file — replaces the internal program memory (Banks 0-9).
- 1-PRESET file — the preset is loaded as the Edit Preset, and can be saved to internal or cartridge memory as detailed in Saving a Preset, Section 2.
- 10-PRESET file — will be loaded into either bank A or B of the internal preset memory as specified before pressing \*YES\*.
- 20-PRESET file — replaces the internal preset memory (Banks A and B).
- 1-SEQ/SONG file — the sequence or song will be loaded into the *lowest-numbered* blank sequencer location in the internal sequencer memory, starting from the first location in Bank 0 and going up from there.
- 30-SEQ/SONGS file — the 30 sequences/songs will be loaded into either the lower half of the sequencer memory (Banks 0-4) or the upper half (Banks 5-9) as specified before pressing \*YES\*.
- 60-SEQ/SONGS file — replaces the entire sequencer memory (Banks 0-9).
- If 30 or programs were saved in a 30-SEQ/SONGS or 60-SEQ/SONGS file along with the sequencer data, a **P** will flash on the upper line of the display when the file is displayed on the DISK LOAD page. When you answer \*YES\* to load the data the VFX<sup>SD</sup> will load the programs automatically with the sequencer data, replacing the programs currently in memory.

### Using File Banks to Locate Files for Loading

As we mentioned earlier, File Banks provide a quick way to locate and select a file for loading. After you have selected LOAD from the DISK Storage menu, the ten Bank buttons will select file banks. From the file banks you can directly select a file to be loaded instead of scrolling through the entire list of files.

Here's how file banks work:

- Press **Storage** and select DISK, then LOAD to get to the Load File display shown earlier.
- Select the file type you want to load.
- Press Bank button 0 and hold it down. The display shows the first File Bank for that file type. For example:

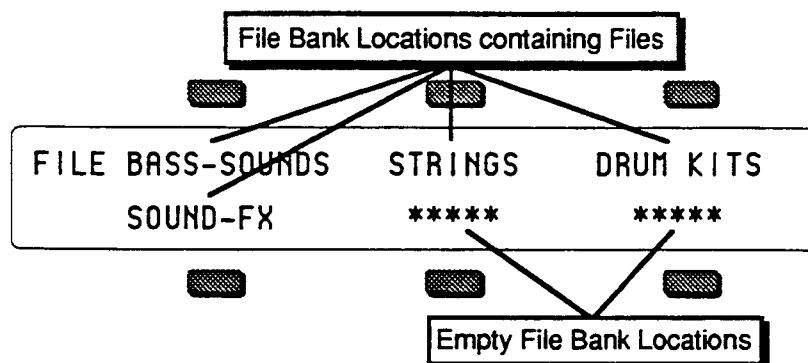

- File bank locations containing a file show the file name. Locations that show \*\*\*\*\* are empty and are cannot be selected. If you release the bank button, the display remains on the file bank for about 1 second and then returns to the Load

File page. This lets you "shop" among the different banks until you find the file you want.

- While the file bank is displayed, press the soft button next to the name of the file you want load. This selects that file as the one to be loaded and instantly returns you to the Load File page.
- Press **\*YES\*** to load the file.

### DELETE — Deleting (Removing) files from Disk

When you press DELETE from the Disk Storage menu, you will see the following display:

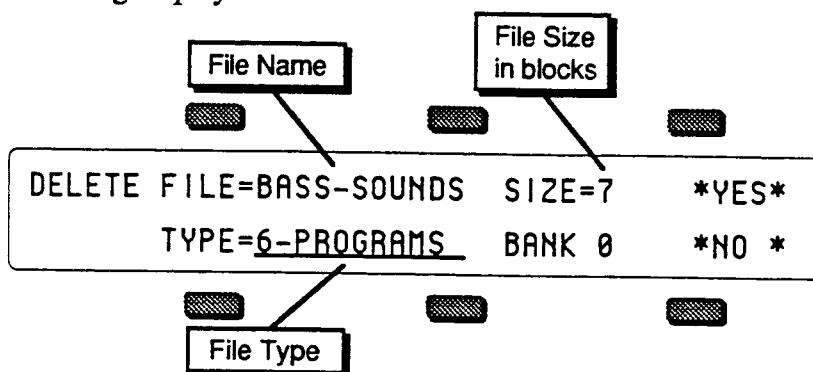

The display shows the *File Name* which identifies the file that will be deleted if you press **\*YES\***; the *Size* of the file in Blocks; and the *File Type*. Only files of the type selected will be shown in the Name field, or in the file banks.

To Delete a file from disk:

- Insert the disk containing the file to be deleted into the disk drive.
- Press **Storage** to go to the Storage Page.
- Press **DISK**. The Disk Storage menu appears.
- Press **DELETE**. The Delete File page appears as shown above. The file type is underlined.
- Select the file type you want from among the 13 available types.
- Press the soft button above the file name and use the data entry controls to find the file you want to delete. (Or you can press the Bank buttons (0-9) and use the File Banks to select the file without scrolling, just as when loading.)
- Press **\*YES\***. The display asks DELETE <FILE NAME>, and warns <FILE TYPE> FILE WILL BE ERASED.
- Press **\*YES\***. The display reads DELETING <FILE NAME>... while the file is being removed. Or press **\*NO\*** to cancel the procedure for any reason.
- After the file is deleted, the VFX<sup>SD</sup> returns to the Delete File page so that you may delete any other files you may want. If you have no more files to delete, press **\*NO\*** to exit.

**MIDI SYS-EX****To Send MIDI Sys-Ex Messages to another VFX<sup>SD</sup> or VFX**

The VFX<sup>SD</sup> is able to send system exclusive dumps of Programs and Presets, either singly or in banks, as well as Sequencer dumps containing either the entire sequencer memory or the current sequence/song. These dumps can be understood by another VFX<sup>SD</sup> or (for programs and presets only) by a VFX.

Banks of programs or presets are always transmitted from the internal RAM. If you want to send cartridge data, use the cartridge functions to transfer data into the internal RAM. If you want to send internal ROM data, you must first reinitialize the VFX<sup>SD</sup> which will replace all of the internal RAM data with copies of the internal ROM data. Be careful to make sure that you have first saved your internal RAM data before reinitializing. Refer to the instructions about reinitializing the VFX<sup>SD</sup> for more information.

From the STORAGE Page—

Press the soft button for MIDI SYS-EX. The display reads:

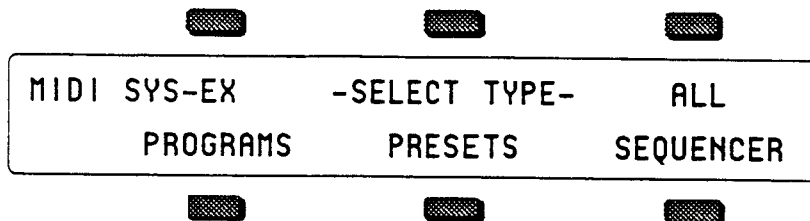

This page is used for selecting which type of data to transmit via MIDI system exclusive message.

**PROGRAMS****To Send Programs out via MIDI Sys-Ex**

From the MIDI SYS-EX Page—

- Press the soft button for PROGRAMS. The display reads:

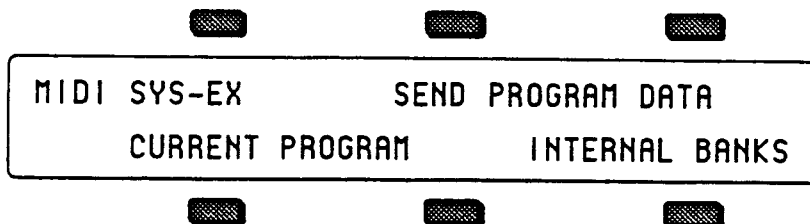

- **CURRENT PROGRAM**—this command will send out all data for the currently selected primary program as a system exclusive message. The program may be in any bank, including the internal ROM or cartridge banks.
- **INTERNAL BANKS**—this command transmits the contents of the ten Internal Program Banks as a system exclusive message. The dump contains data for the complete set of 60 programs.

**PRESETS****To send Presets out Sys-EX**

From the MIDI SYS-EX Page—

- Press the soft button for PRESETS. The display reads:

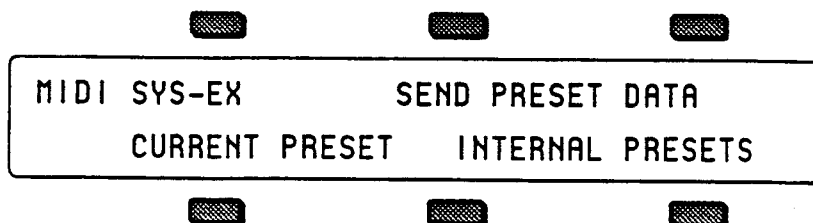

- **CURRENT PRESET**—this command will send out all data for the current Preset as a system exclusive message.
- **INTERNAL PRESETS**—this command transmits the contents of the of the two Internal Preset Banks as a system exclusive message. The dump contains data for the complete set of 20 presets.

**SEQUENCER DATA****To Send Sequences/Songs out via MIDI Sys-Ex**

From the MIDI SYS-EX Page—

- Press the soft button for SEQUENCER. The display reads:

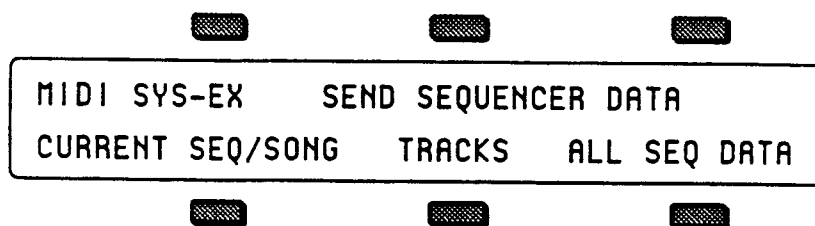

- **CURRENT SEQ/SONG** — this command will send out all data for the currently selected sequence or song as a system exclusive message.
- **TRACKS** — Transmits all information about the 12 tracks and the effect in the current sequence or song (not including recorded track data) as a system exclusive message. This message can be understood by a VFX as a Multi-Set message. If received by a VFX<sup>SD</sup> it will change the effect and reconfigure the tracks of the current sequence or song.
- **ALL SEQ DATA**—this command transmits the contents of the ten Sequencer Banks as a system exclusive message. The dump contains data for the complete set of 60 sequencer locations.

**ALL****Sending Programs, Presets and All Sequencer data out via MIDI Sys-Ex**

From the MIDI SYS-EX Page—

- Press the soft button for ALL. The VFX<sup>SD</sup> will transmit three consecutive dump messages containing the internal Program banks, the internal Preset banks, and the entire Sequencer memory. Using this command is equivalent to sending the three messages individually, and is convenient when you wish to transmit everything with one command.

### Receiving MIDI Sys-Ex Messages

The receiving of data dumps is initiated automatically by system exclusive messages sent from the transmitting unit. No front-panel commands are necessary to receive dumps if the receiving of System Exclusive messages is enabled on the MIDI Control page (SYS-EX=ON).

### Cartridge Storage

From the STORAGE Page—

- Press the soft button for CARTRIDGE. The display reads:

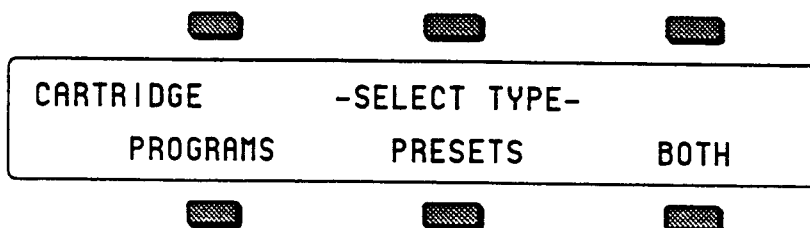

This page lets you select the type of data to be transferred to or from the cartridge.

### PROGRAMS

#### To Copy Program Banks from Internal to Cartridge

From the CARTRIDGE -SELECT TYPE- Page—

- Press the soft button for PROGRAMS. The display reads:

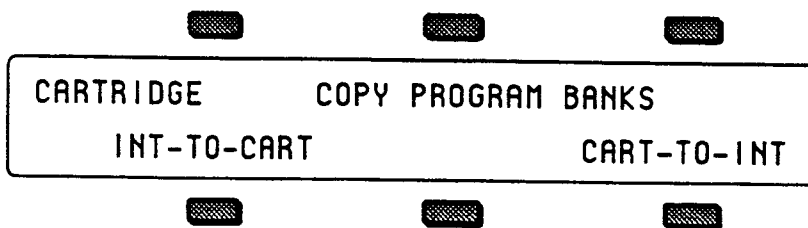

This page lets you decide on the direction (i.e. the source and destination) for the data transfer of the type you have selected.

From the CARTRIDGE COPY PROGRAM BANKS Page—

- Press the soft button for INT-TO-CART. The display reads:

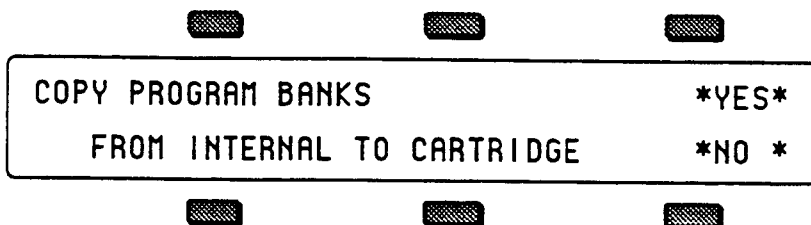

- Respond **\*YES\*** if you want to copy program banks from the VFX<sup>SD</sup>'s internal memory to the storage cartridge. This will replace all of the cartridge programs with the 60 programs from the internal banks, and the old cartridge programs will be lost.
- Selecting **\*NO \*** will abort the command and return you to the Storage page.

To Copy Programs from Cartridge to Internal

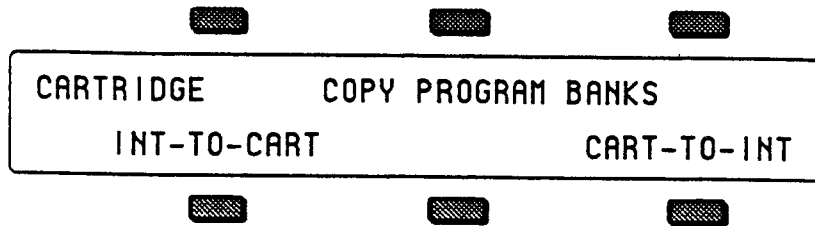

From the CARTRIDGE COPY PROGRAM BANKS Page—  
 • Press the soft button for CART-TO-INT. The display reads:

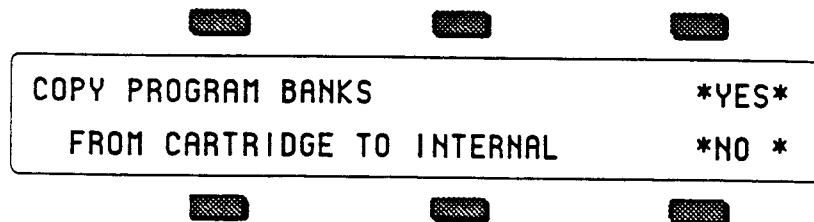

- Respond **\*YES\*** if you wish to complete the transfer of the ten program banks from the storage cartridge to VFX<sup>SD</sup>'s internal program memory. This will replace all of the internal programs with the 60 programs from the cartridge, and the old internal programs will be lost.
- Selecting **\*NO \*** will abort the command and return you to the Storage page.

PRESETS

To Copy Presets from Cartridge to Internal

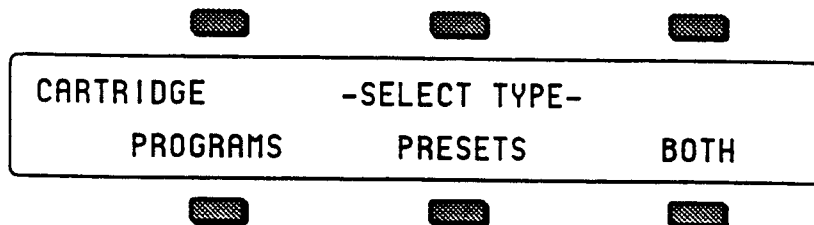

From the CARTRIDGE -SELECT TYPE- Page—  
 • Press the soft button for PRESETS. The display reads:

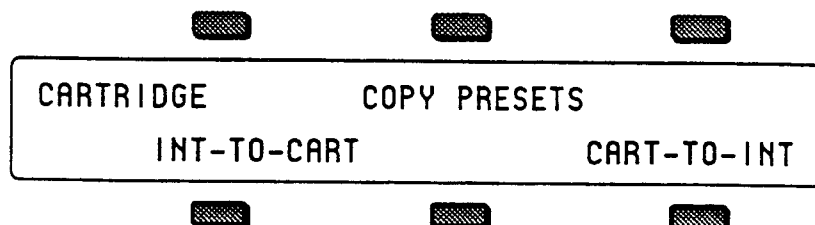



- Press the soft button for CART-TO-INT. The display reads:

COPY PRESETS	*YES*
FROM CARTRIDGE TO INTERNAL	*NO *

- Respond \*YES\* if you wish to complete the transfer of the 20 presets from the storage cartridge to VFX<sup>SD</sup>'s internal memory. This will replace all of the internal presets with the 20 presets from the cartridge, and the old internal presets will be lost.
- Selecting \*NO\* will abort the command and return you to the Storage page.

### To Copy Presets from Internal to Cartridge

From the CARTRIDGE -SELECT TYPE- Page—

- Press the soft button for PRESETS. Then, from the CARTRIDGE - COPY PRESETS page, press the soft button for INT-TO-CART. The display reads:

COPY PRESETS	*YES*
FROM INTERNAL TO CARTRIDGE	*NO *

- Respond \*YES\* if you want to copy the 20 presets from the VFX<sup>SD</sup>'s internal memory to the storage cartridge. This will replace all of the cartridge presets with the 20 presets from the internal banks, and the old cartridge presets will be lost.
- Selecting \*NO\* will abort the command and return you to the Storage page.

**BOTH**

To Copy Both Programs & Presets from Internal to Cartridge

CARTRIDGE	-SELECT TYPE-	
PROGRAMS	PRESETS	BOTH

From the CARTRIDGE -SELECT TYPE- Page—

- Press the soft button for BOTH. The display reads:

CARTRIDGE	COPY PROGRAMS AND PRESETS	
INT-TO-CART	CART-TO-INT	

- Press the soft button for INT-TO-CART. The display reads:

COPY PROGRAMS AND PRESETS	*YES*
FROM INTERNAL TO CARTRIDGE	*NO *

- Respond \*YES\* if you wish to copy Programs and Presets from the VFX<sup>SD</sup> to the cartridge. The display reads:

CONVERT PRESET PROGRAMS	*YES*
	*NO *

When you are copying BOTH Presets and Programs from INT to CART, you will be prompted to decide whether you would like to have the program numbers in the presets converted as the transfer is taking place. This conversion makes the presets which previously used internal programs now use the same programs from the cartridge. ROM programs are not affected.

If you respond \*YES\* to CONVERT PRESET PROGRAMS, the VFX<sup>SD</sup> will automatically modify the Presets which used internal programs to use the corresponding programs on the cartridge.

If you respond \*NO \* to the prompt, then the copying of both Presets and Programs will be completed, but no conversion will be done.

**To Copy Both Programs & Presets from Cartridge to Internal**

From the CARTRIDGE COPY PROGRAMS AND PRESETS Page—

- Press the soft button for CART-TO-INT. The display reads:

COPY PROGRAMS AND PRESETS		*YES*
FROM CARTRIDGE TO INTERNAL		*NO *

As with the case of copying both programs and presets from internal to cartridge, if you select \*YES\*, you will be prompted to decide about converting the programs in the presets.

CONVERT PRESET PROGRAMS		*YES*
		*NO *

When you are copying both Presets and Programs from CART to INT and you respond \*YES\* to CONVERT PRESET PROGRAMS the VFX<sup>SD</sup> will change the presets to use the INT Programs (which will be the same as those in the cartridge, since you are copying them at the same time).

## MIDI System Exclusive Recorder

### What are System Exclusives?

Some MIDI information—such as key events, controllers, program changes, etc.—is understood by virtually all MIDI devices, regardless of manufacturer. The common ability to send and receive these messages is what allows you to play any MIDI synth from any other, to change programs and volume remotely, to start and stop sequencers and drum machines together, and the many other performance miracles we have come to expect from MIDI.

There are other messages which each manufacturer has reserved for communicating specific information with a specific machine (or family of machines). These machine-specific messages are called *System Exclusive* (or Sys-Ex) messages, since they are meant to be recognized only by a particular device and ignored by all others (i.e. they are exclusive to a particular system).

The VFX<sup>SD</sup>, for example, can transfer programs, presets or sequences or via to another VFX<sup>SD</sup>. It is a lot like sending a file from one computer to another via modem. The 1's and 0's that make up the data in memory are sent out the MIDI port. This data can be received and understood by another VFX<sup>SD</sup>, by a VFX (for many types of VFX<sup>SD</sup> data), or by a computer running the proper librarian software.

### "Generic" System Exclusive Storage

It is not strictly necessary, however, for the receiving system to understand the data it receives, if the purpose is to store it for later reloading into the original system (just as it's not necessary for a file cabinet to understand the pieces of paper you file there). The VFX<sup>SD</sup> can receive any MIDI System Exclusive message up to 96k bytes (288k with the memory expansion installed) and save it to disk without having the slightest notion what it means or what type of device it came from. When you want to send the data back to the original device, you just load the data from disk back into the VFX<sup>SD</sup>, which will then re-transmit the message exactly as it was received.

Here are a few examples of the kinds of information which you can use the VFX<sup>SD</sup> to store in this way:

- The Program (patch) memory of virtually any MIDI synthesizer
- The pattern memory a drum machine
- The sequence memory of a MIDI sequencer
- The preset memory of any MIDI reverb or other effects device which can send and receive it

In short, any MIDI data (within memory limits) which can be transmitted from one device to another can be received and stored by the VFX<sup>SD</sup>. With the VFX<sup>SD</sup> at the heart of your system you now have disk storage for the data in all your MIDI instruments.

### Saving Sys-Ex data uses the Sequencer Memory

The VFX<sup>SD</sup> uses the RAM (Random Access Memory) that is normally devoted to the sequencer to "buffer" incoming System Exclusive messages before saving them to disk. A buffer is an area of memory where data is held temporarily. When the VFX<sup>SD</sup> receives a System Exclusive data dump, it stores it in the sequencer memory until you save the data to disk.

**Important:** *You must save all sequencer memory before using the System Exclusive Recorder function to receive data.*

Loading Sys-Ex data from disk to an external device will not necessarily clear the sequencer memory. If there is enough unused sequencer memory to load and transmit the Sys-ex message, the memory will not be affected. If there is not enough memory, the VFX<sup>SD</sup> will warn you of that and give you a chance to proceed (erasing the sequencer memory) or quit and save the data.

### SAVING System Exclusive Data from an External Device

Using the VFX<sup>SD</sup>'s disk drive for storing data from external devices is a three-step process:

- 1) first you get the VFX<sup>SD</sup> ready to receive the data via MIDI;
- 2) next, you send the data from the external device to the VFX<sup>SD</sup>; and finally
- 3) you save the data to a disk with the VFX<sup>SD</sup>'s disk drive.

To Save system exclusive data from an external MIDI device:

- Connect the MIDI Out of the sending device to the MIDI In of the VFX<sup>SD</sup>.
- Insert a formatted double-sided 3.5" disk into the VFX<sup>SD</sup> disk drive.
- Press the **Storage** button to select the Storage Page
- Press DISK. The Disk Storage menu appears.
- Press SYS-EX REC.
- The display shows "SEQUENCER DATA WILL BE ERASED" to warn you that any sequences and songs currently in memory will be lost. It's not too late, however, to quit and preserve the sequencer memory intact. Pressing \*NO\* at this point will return you to the Storage page without erasing the sequencer memory, allowing you to save it to disk before proceeding.
- Press \*YES\* to proceed. The following screen appears:

■	■	■
SYS-EX REC	STATUS=WAITING...	SIZE=0
SAVE	SEND	*EXIT*
■	■	■

The VFX<sup>SD</sup> will now record into its memory any System Exclusive message which it receives. At the upper right of the display (SIZE=##) you see the size (expressed in disk blocks) of the Sys-Ex data received so far.

- > Pressing SAVE lets you name and save to disk what has been received so far (don't do that yet).
- > Pressing SEND will re-transmit whatever has been received so far (don't do that yet either).
- > Pressing \*EXIT\* returns you to the Storage Page.

- From the external MIDI device, transmit the System Exclusive data. The display will read STATUS=RECEIVING.... while the data is being sent.
- When the full message has been received, the display will read STATUS=COMPLETE to indicate that a complete message was recorded. The display shows how many blocks of data have been received so far. At this point, assuming there's enough memory, you can send the VFX<sup>SD</sup> another System Exclusive message (from a different instrument, for example) which will be stored right after the first one. You can save as many different messages

as memory permits in a single Sys-Ex block. Each time, the VFX<sup>SD</sup> will read STATUS=RECEIVING... and then return with STATUS=COMPLETE when the complete message has been received. When the data is later re-transmitted, all the messages will be sent out in the order they were received, with a 100 millisecond pause between each. In this way you could load new data into all your devices with a single Load command from the VFX<sup>SD</sup>.

- Once you have successfully received the Sys-Ex message (or messages), press SAVE. The standard SAVE FILE display appears:

SAVE FILE	NAME=SYS-EX-FILE	*YES*
LEFT -CURSOR-	RIGHT	*NO*

- Name the file with an 11-character name of your choice using the data entry controls and the two cursor soft buttons, labeled LEFT and RIGHT. (Or you can use the keyboard to select characters and move the cursor, if Keyboard Naming is enabled on the Master page)
- Press \*YES\*. The Display reads SAVING <FILENAME> while the data is being saved. Or Press \*NO\* to cancel the procedure for any reason.
- If there is a Sys-Ex file with the same name already on the disk, the VFX<sup>SD</sup> will ask DELETE OLD VERSION? Press \*YES\* to save the file, replacing the one on the disk. This is for updating files to which you have made changes. Or press \*NO\* to abort the procedure.
- After the file is saved, the VFX<sup>SD</sup> returns to the SAVE FILE page, so that you can save the a backup copy of the data to a different disk if you wish. Press \*NO\* (or any other front panel button) to exit.

**Note:**

If during the reception of Sys-Ex data the VFX<sup>SD</sup> display reads STATUS=INCOMPLETE, this means it did not receive an "End Of Exclusive" after the System Exclusive message. This would indicate that external device did not transmit a complete message for some reason. Press \*EXIT\* and try again.

If the VFX<sup>SD</sup> display reads STATUS=MEMORY FULL, this means it ran out of memory with which to "buffer" the incoming data. (The maximum amount which can be received is 192 blocks for a standard VFX<sup>SD</sup>, 576 blocks with the memory expansion option installed.) After receiving the Memory Full message you can still save the file, but it is almost certain that the last Sys-Ex message received is incomplete and will not be able to be received successfully when re-transmitted.

**LOADING System Exclusive Data from Disk to an External Device**

After you have saved a System Exclusive message from an external MIDI instrument, getting the data back to the original instrument involves three steps:

- 1) First you prepare the receiving instrument(s) to receive System Exclusive messages via MIDI;
- 2) next, you Load the data from the VFX<sup>SD</sup>'s disk drive into memory; and then
- 3) you send the data to the remote instrument(s) from the VFX<sup>SD</sup>.

To Load (and Transmit) a System Exclusive File from disk:

- Connect the MIDI Out of the VFX<sup>SD</sup> to the MIDI In of the receiving device(s).
- Enable the receiving instrument(s) to receive System Exclusive messages. Many devices have a switch or a parameter which enables or disables the receiving of System Exclusive messages. Consult the manual of each particular device for details.
- Insert the disk containing the Sys-Ex data into the disk drive.
- Press *Storage* to select the Storage Page.
- Press DISK. The Disk Storage menu appears.
- Press LOAD. The Load File display appears as shown earlier. The file type is underlined.
- Use the data entry controls to select the file type SYS-EX DATA.
- Press the soft button above the file name and use the data entry controls to find the file you want to transmit. (Or can use the File Banks to quickly locate the file without scrolling as detailed earlier in this section)
- Press \*YES\*.
- If there is not enough free sequencer memory to hold the Sys-Ex data, the display shows SEQUENCER DATA WILL BE ERASED. If you have sequencer data in memory which hasn't been saved, press \*NO\* to return to the Storage Page and save it to disk before proceeding. Otherwise, press \*YES\*.
- The display reads LOADING <FILENAME> while the data is being loaded. Once the data is in memory, the Sys-Ex Recorder screen appears:

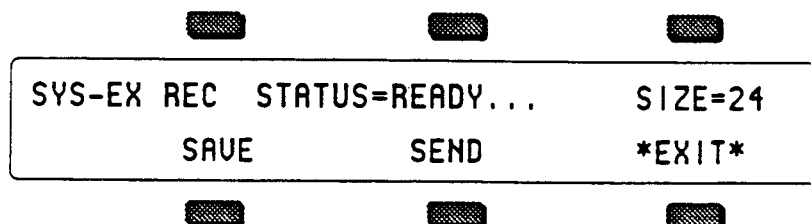

- Press SEND to transmit the data. The display reads STATUS=SENDING, and then returns to STATUS=READY..., ready to send the data again if necessary.
- Check the receiving instrument(s) to see that the data was received correctly. If it wasn't, make sure that:
  - > the MIDI connections are correct (VFX<sup>SD</sup>'s MIDI Out to the receiving device's MIDI In),
  - > the receiving device(s) is enabled to receive System Exclusive messages,
  - > the receiving device(s) is set to the same MIDI base channel(s) as when the data was initially sent to the VFX<sup>SD</sup>.
 Then press SEND again, and the data will be transmitted again. You can keep repeating this until the data has been successfully received by the remote device(s).
- Once the data has been successfully transmitted, press EXIT.

### **Additional Sys-Ex Recorder Notes**

As you have no doubt noticed, the VFX<sup>SD</sup> displays exactly the same page for sending and receiving Sys-Ex data. In fact, MIDI System Exclusive data can be transmitted or received any time this page is on the display, regardless of which way you entered it.

Whenever this page is displayed:

- Pressing SEND will transmit whatever is in the MIDI Sys-Ex buffer.
- Incoming MIDI Sys-Ex messages will be recorded and added to the data already in the buffer memory.
- Pressing SAVE will always take you to the SAVE FILE page where you can name and save to disk the data in the buffer memory.

This allows a number of useful applications. You can, for example, load a Sys-Ex file from disk, then transmit to the VFX<sup>SD</sup> an additional message or messages, adding that data to the original data, and then re-save the file to disk. Or you can press SEND to re-transmit a Sys-Ex message immediately after it has been received, to check and see that it was received properly.



## VFX<sup>SD</sup> Disk Error Messages

### WARNINGS

Warnings are displayed for one second and indicate either successful completion or non-fatal error conditions encountered during a disk operation.

- **DISK COMMAND COMPLETED** — indicates that the disk operation was completed successfully and without errors.
- **DISK WRITE-PROTECTED** — appears during SAVE or DELETE operations if the diskette is write-protected.
- **DISK HAS BEEN CHANGED** — appears when you respond \*YES\* to LOAD, SAVE or DELETE when the disk in the drive has been changed since the last time the VFX<sup>SD</sup> loaded a disk directory.
- **DISK DRIVE NOT READY** — usually indicates that there is no diskette in the drive, although it can indicate a hardware problem if it persists.
- **NOT ENOUGH DISK SPACE** — indicates that there are not enough available sectors on diskette to save the file.
- **FILE DOES NOT EXIST** — appears when you respond \*YES\* to LOAD or DELETE when the display shows FILE=\*NO FILES\*.
- **INCOMPATIBLE SEQ OS VERSION** — indicates that the version of the Sequencer OS on the disk cannot be loaded either because the OS ROMs in the system require a more recent disk version, or because the disk version requires more recent OS ROMs.
- **DISK COMMAND NOT COMPLETED** — appears when you respond \*NO\* to DELETE OLD VERSION? when saving files.
- **NO FREE DISK FILES** — indicated that there are no free directory entries in which to save the file.
- **NO SYS-EX DATA TO SAVE** — indicates that there is no data in the Sys-Ex Recorder to save.
- **FILE TOO LARGE TO LOAD** — indicates that the sequence data in the file will not fit into the free memory. Delete sequences or songs to make some memory available. If that does not work, the file may have been saved from a system with expanded memory.

### FATAL ERROR MESSAGES

Fatal error messages are always accompanied by the PRESS ANY BUTTON TO CONTINUE... prompt, and remain on the screen until any button is pressed. These messages indicate serious error conditions which interrupted the disk operation. These errors may have prevented the correct saving or loading of the data in the file(s).

- **DISK DRIVE NOT RESPONDING** — indicates either that there is no diskette in the drive or that there are hardware problems.

- **DISK NOT FORMATTED** — the disk format was not recognized, and the disk is either blank or formatted for some other system.
- **NOT VFX-SD DISK** — the disk format was recognized, but the disk does not contain VFX<sup>SD</sup> data.
- **DISK ERROR - WRITE VERIFY** — during a SAVE operation, the data written could not be verified. Probably indicates a bad disk sector. The file may be unusable.
- **DISK ERROR - LOST DATA** — during a disk read operation, the system missed data coming from the disk. Probably indicates a hardware problem. The file may be unusable.
- **FILE OPERATION ERROR** — one of a number of possible fatal errors occurred during a disk operation. Probably caused by a low-level hardware or software error, although the disk may be bad.
- **DISK ERROR - BAD DATA** — during a file operation, the CRC (error checking code) of the data block was incorrect. Probably indicates a bad disk sector. The file may be unusable.
- **DISK ERROR - BAD DISK OS** — during a file operation, the CRC of the Disk OS Program Control Block was incorrect. Probably indicates a bad disk sector. The disk may be unusable.
- **DISK ERROR - BAD DIRECTORY**— during a file operation, the CRC of the Directory blocks was incorrect. Probably indicates a bad disk sector. The disk may be unusable.
- **DISK ERROR - BAD FAT** — during a file operation, the CRC of the FAT (File Allocation Table) block was incorrect. Probably indicates a bad disk sector. The disk may be unusable.
- **DISK ERROR - BAD DEVICE ID** — during a file operation, the CRC of the Device ID block was incorrect. Probably indicates a bad disk sector. The disk may be unusable.
- **FORMAT FAILED - BAD DISK** — during formatting, a bad disk sector was detected. The disk may be defective, and should not be used.
- **OS NOT ON DISK** — the system was unable to LOAD the Sequencer OS file. The file may be unusable.
- **DISK COPY NOT COMPLETED** — appears if \*QUIT\* is pressed during the Disk Copy procedure.

## Section 12 — Sequencer Edit Functions

Edit Song Page — Song Edit Functions . . . . .	12 - 1
Editing Song Steps — Using the Song Step Editor . . . . .	12 - 4
Edit Seq Page — Sequence Edit Functions . . . . .	12 - 6
Edit Track Page — Track Edit Functions . . . . .	12 - 10
Edit Track Range Page — Setting the Time and Key range . . . . .	12 - 10
Track Edit Functions . . . . .	12 - 11

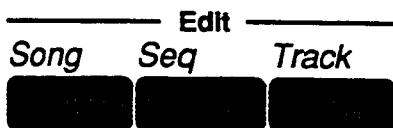

The three Edit buttons in the top row of the Sequencer section provide access to the various sequencer editing functions. These are divided into Song, Seq, and Track edit functions. Pressing any of these three buttons shows a menu of the available functions in that category.

### Edit Song Page — Song Edit Functions

Pressing the *Edit Song* button displays the top level song editing page. Pressing the button twice will display the Song Step Editor. If you press the *Edit Song* button when a sequence is selected, the display will respond "SONG NOT SELECTED" and will not allow you onto this page.

The following functions can be selected from the Edit Song page:

- INFO — Provides information about the song and lets you adjust the tempo.
- ERASE — Erase and undefine the song.
- COPY — Copy the song to another sequencer location.
- EDIT STEPS — Edit the song steps, chaining sequences together to form the basic song structure.

Press the *Edit Song* button. The display shows:

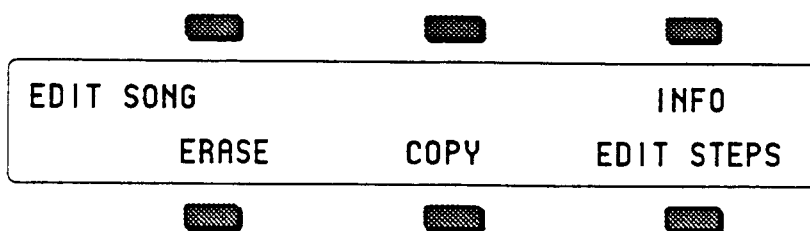

#### INFO

Pressing INFO displays a page containing information about the song, including the number of steps, the size in blocks, the song tempo offset and the elapsed time at the current tempo. From this page you can also rename the song. The readouts and active controls on this page are:

SONG	NAME=\$SONG-32	SIZE=3
INFO	TEMPO=+04 STEPS=12	TIME=004.46.00

- **NAME** — Renaming a song. Pressing the soft button above the Song Name displays a sub-page which allows you to edit the name of the song. Use the data entry controls and the LEFT and RIGHT cursor buttons to rename the song. Then press **\*SAVE\*** to return to the INFO page with the new name.
- **SIZE** — Displays the size of the current song in events. Readout only.
- **TEMPO** — Song Tempo Offset. This lets you speed up or slow down the entire song without changing the component sequences. It is expressed as a percentage of the sequence tempo — changing the song tempo offset automatically adjusts the tempo of each of the sequences in the song by +/-99%, within the legal limits of 25-250 BPM.
- **STEPS** — Indicates the number of steps in the song. Readout only.
- **TIME** — Total Song Time. This shows you the total time of the song in minutes, seconds, and hundredths of a second. It is readout only — you cannot directly change it. However, when you change the Song Tempo Offset (above) you will see the time readout change accordingly.

## ERASE

The Erase command will erase the currently selected song and leave its location undefined. First, make sure the Song you want to erase is selected. Then:

- Press **Edit Song**.
- Press ERASE. The display asks "ERASE CURRENT SONG <SONG NAME> FROM LOCATION ##?".
- Press **\*YES\*** to erase and undefine the song. Or press **\*NO\*** to cancel.

## COPY

Use this command to make a copy of the currently selected song in another sequencer location. Note that the original song remains intact in its original location. First, make sure the Song you want to copy is selected. Then:

- Press **Edit Song**.
- Press COPY. The display shows:

COPY SONG	\$SONG-32	*YES*
TO NEW LOC=	05	*NO *

- Use the data entry controls to select a location for the copied song. Note that only undefined sequencer locations will be available for selecting.
- Press **\*YES\*** to copy the song (or press **\*NO\*** to cancel). The new song will

be given the same name as the original one you copied. You can rename it from the Edit Song INFO page as described above.

### EDIT STEPS — Song Step Editor Page

Pressing EDIT STEPS displays the song step editor page. Here you chain sequences together to define the basic structure of the song.

A song is composed of *Steps*. Each Step consists of:

- A sequence which will play during that step,
- The number of Repetitions, or *Reps*, of the sequence during the step, and
- The Mute and Transpose status for each sequence track during the step.

When you select EDIT, the display shows the Song Step Editor page:

EDIT	INSERT	DELETE	TRACKS
SONG	STEP= <u>001</u>	SEQ=SEQUENCE-02	REPS=02

- INSERT — inserts a blank song step *before* current song step.
- DELETE — removes the current song step, and shifts the remaining steps down to fill the gap.
- STEP — While this field is selected, the step number can be edited using the data entry slider or the up and down arrows, allowing you to move up and down through the song and view each step.
- SEQ — Selects the sequence to be used for the current song step. An empty song step will show SEQ= -BLANK-. To put a sequence into an empty song step (thus defining the step) simply underline this field and then press the up arrow button. The final step (the one after the last defined song step) will always read SEQ=\*SONG-END\*. To add at the end of the song, select SEQ=\*SONG-END\* and press up arrow to define the step. This puts a sequence in that step and moves the Song End back one more step.
- REPS — This controls the number of times the sequence in the current song step will be repeated. The range is 01 to 99, or FS.

FS stands for Foot Switch. When REPS=FS, the song step will loop continuously until the Aux foot switch (available only when the optional SW-5 foot switch is connected) is pressed. When the foot switch is pressed, the current step will finish playing and then advance to the next step.

- **TRACKS** — selecting this option from the song step editor page displays a sub-page which allows you to *Mute* or *Transpose* specified tracks for the current song step.

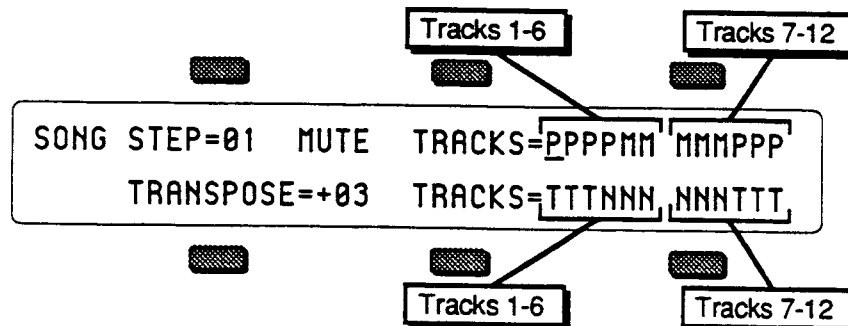

- **STEP** — Shows the current step number. Pressing this button again when it is already selected will return you to the Song Step Editor page.
- **MUTE TRACKS** — The number 2 and 3 soft buttons each select a group of 6 positions which control the muting of sequence tracks for the current song step. Repeated presses of the soft button will scroll across the set of 6 tracks, and allow each track to be muted or unmuted individually. An **M** indicates that the track is muted for the entire step, and a **P** indicates that the track will play.
- **TRANPOSE** — Sets the transpose amount to be used by any tracks which are set to Transpose for that song step (see below). This will raise or lower the pitch of the entire track. Range is -12 to +12, each increment representing one semitone.
- **TRANPOSE TRACKS** — The number 5 and 6 soft buttons each select a group of 6 positions which control the transposition of tracks for the current song step. Repeated presses of the soft button will scroll across the set of 6 tracks, and allow each track to be transposed or left untransposed (normal) individually. A **T** indicates that the track will be transposed, and an **N** indicates that the track will play at normal pitch.

### Editing Song Steps — Using the Song Step Editor

For each Song Step you want to create:

- Select the Sequence Name field, which for Step 1 of a new song will read: SEQ= \*SONG-END\*.
- Press the up or down arrow button to define the song step and select among the sequences in memory until the display is showing the name of the sequence you want to play during that step.
- Select the number of Repeats (REPS=##), and adjust the number of times you want the sequence to play during the step. (If you only want the sequence to play once during the song step, leave it set to 01.)
- Press TRACKS to reveal the Mute/Transpose sub-page shown above. If you want to mute any tracks for that step, select the character(s) representing the track(s) on the upper line of the display and set to **M**. To transpose tracks during the step, select the character(s) representing the track(s) on the lower line of the display and set to **T**. Select and adjust the Transpose amount.
- Press STEP=## twice to return to the Song Step Editor page.
- Once the Sequence and number of Reps is correct, select STEP=## and press

the up arrow button to select the next step (STEP=\*SONG-END\*) and edit that in the same way. For each successive Song Step, select the Sequence Name and use the up and down arrow buttons to choose a sequence; then set the number of repeats, then proceed to the next step.

- There is always one final step which reads SEQ=\*SONG-END\*) *after* the last defined step in the Song.

To go to a different Step in the Song:

- Underline Step Number, and use the up or down arrow buttons to go to any step within the song. After you have finished editing the Song Steps (or at any point during the process, for that matter) you can go back through the song to check that all the steps are right.

To change anything in an existing Song Step:

- To change any of the variables (sequence name, number of reps, track mute or transpose status) within a Song Step which has already been created, simply go to that step, as described above, select the thing you want to edit and change it.

To Insert a step anywhere in the song:

- Press STEP=## and go to the step *before which* you want to insert the step. That is, if you want to insert a step between Step 2 and Step 3, go to Step 3.
- Press INSERT. A Blank step (the display reads SEQ = -BLANK-) is created.
- Select the Sequence Name field and use the up and down arrow buttons to select a sequence for the new Step.
- Set the number of repeats and any mute or transpose settings for the step as shown earlier.

To Delete a step anywhere in the song:

- Press STEP=## and go to the step which you want to delete.
- Press DELETE. The step is erased and all steps after it are moved down by one.

When you are done editing the song, press *Locate* (or any other sequencer page button) to exit. You can then press *Play* to hear your new song.

## Edit Seq Page — Sequence Edit Functions

Pressing the *Edit Seq* button displays the sequence editing page. Pressing the button twice will display the sub-page containing the Add and Delete Bars functions.

The following functions can be selected from the Edit Song page:

- APPEND — Lets you append (attach) one sequence onto another.
- INFO — Provides information about the sequence; lets you adjust the tempo and, indirectly, the elapsed time.
- ERASE — Erase and undefine the sequence.
- COPY — Copy the sequence to another sequencer location.
- ADD & DELETE BARS — Increase or decrease the length of the sequence.
- Press the *Edit Seq* button. The display shows:

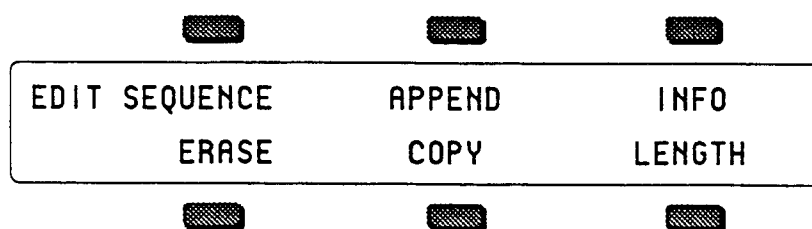

### APPEND

This function allows you to append one sequence onto the end of another (or to itself, doubling its length). A sequence which you specify will be appended (or "tacked on") to the the end of the currently selected sequence.

- Make sure the sequence onto which you want to append another is selected.
- Press *Edit Seq*.
- Press APPEND. The display shows:

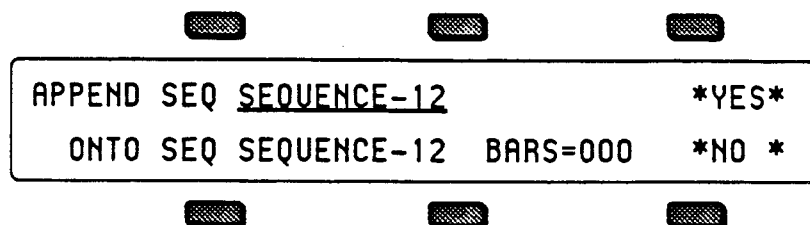

- Use the data entry controls to select the sequence which will be appended to the current sequence. (The default source is the current sequence, which allows the current sequence to be easily appended to itself.)
- The bottom of the display shows the destination sequence, and the total number of bars in the current sequence.
- Press \*YES\* to append the sequence specified in the top line of the display onto the end of the current sequence. (or press \*NO\* to cancel).

### INFO

Selecting INFO displays a page of information about the currently selected sequence, including the name, the size in blocks, the tempo, the number of bars and the elapsed time at the current tempo. The tempo is the only field which can be directly edited, but the elapsed time field will be updated to reflect the new tempo.



SEQ	NAME-SEQUENCE-32	SIZE=51
INFO	TEMPO=144 BARS=016	TIME=003.12.50

- **NAME** — Renaming a sequence. Pressing the soft button above the sequence Name displays a sub-page which allows you to edit the name of the sequence. Use the data entry controls and the LEFT and RIGHT cursor buttons to rename the sequence. Then press \*SAVE\* to return to the INFO page.
- **SIZE** — displays the size of the current sequence in events. Readout only.
- **TEMPO** — This displays the tempo of the current sequence. Changing the tempo here has the same effect as changing it on the three other pages where tempo appears, Click, Seq Control and Locate. On this page, however you can see the elapsed time change as you change the tempo (see below).
- **BARS** — Indicates the number of bars in the sequence. Readout only.
- **TIME** — Elapsed Sequence Time. This shows you the total time of the sequence in minutes, seconds, and hundredths of a second. It is readout only — you cannot directly change it. However, when you change the tempo (above) you will see the time readout change accordingly.

## ERASE

The Erase command will delete the currently selected sequence from memory and leave its location undefined (-BLANK-). First, make sure the sequence you want to erase is selected. Then:

- Press *Edit Seq.*
- Press ERASE. The display asks "ERASE CURRENT SEQ <SEQ-NAME> FROM LOCATION ##?".
- Press \*YES\* to erase and undefine the sequence. Or press \*NO\* to cancel.

## COPY

Use this command to make a copy of the currently selected sequence in another sequencer location. Note that the original sequence remains intact in its original location. First, make sure the sequence you want to copy is selected. Then:

- Press *Edit Seq.*
- Press COPY. The display shows:

COPY SEQ	SEQUENCE-12	*YES*
TO NEW LOC	<u>25</u>	*NO *

- Use the data entry controls to select a location for the copied sequence. Note that only -BLANK- sequencer locations will be available for selecting.
- Press \*YES\* to copy the sequence (or press \*NO\* to cancel). The new

sequence will be given the same name as source sequence. You can then rename it from the Edit Seq/INFO page if you wish.

### LENGTH — Add and Delete Bars from a Sequence

Though the length of the first track determines the length of the sequence, you can use the Add Bars and Delete Bars functions to add empty bars, starting from any bar within the sequence, or to remove any number of bars from the sequence.

From the Edit Seq page, press LENGTH. The display shows:

```

      [ ]      [ ]      [ ]
  EDIT SEQ SEQUENCE-23 BARS=12 4/4
      *EXIT*  ADD BARS  DELETE BARS
      [ ]      [ ]      [ ]
  
```

This sub-page shows the name, time signature, and number of bars in the sequence, as well as the Add and Delete Bars commands.

### ADD BARS

The Add Bars function lets you add any number of bars to the sequence up to a total sequence length of 999 bars. It consists of two steps: 1) you specify at which bar you want to start adding bars, and then 2) you select how many bars you want to add.

To ADD Bars to the selected sequence:

- Make sure the sequence to which you want to add bars is selected.
- Press the *Edit Seq*, and press LENGTH.
- Press ADD BARS — the display shows the following:

```

      [ ]      [ ]      [ ]
  AT BAR 5 ADD 4 BARS *YES*
                        *NO *
      [ ]      [ ]      [ ]
  
```

- Press the soft button above AT BAR ## on the display.
- Use the data entry controls to determine at which bar the new measures will be added. This can be any bar within the sequence:
  - > Selecting Bar 01 will cause bars to be added at the beginning of the sequence.
  - > Selecting the bar *after* the last bar of the sequence will cause bars to be added at the end of the sequence.
  - > Selecting any other bar will cause bars to be added starting from that point in the sequence.
- Press the soft button above the number of bars.
- Use the data entry controls to select how many bars you want to add. You can add any number up to a total sequence length of 999 bars. Empty bars (no track data) will be added beginning from the bar selected in the previous step.
- Press \*YES\* to complete the command, or press \*NO\* to cancel.

**DELETE BARS**

The Delete Bars function lets you delete (or remove) any number of bars from a sequence, starting from any bar within the sequence.

This is handy when, for example, you record a first track which is perfect except that it runs to 5 Bars instead of 4. With this edit function you can easily chop off the extra bar.

To DELETE Bars from the selected sequence:

- Make sure the Sequence from which you want to delete bars is selected.
- Press the *Edit Seq*, and press LENGTH.
- Press DELETE BARS — the display shows the following:

The screenshot shows a rectangular display window with a black border. Inside the window, the text reads "AT BAR 5 DELETED 4 BARS" on the first line and "\*YES\*" and "\*NO\*" on the second line. Above and below the window are three small, dark, rectangular buttons, likely representing the data entry controls mentioned in the text.

- Use the data entry controls to determine at which bar you want to begin removing bars. This can be any Bar within the Sequence. Bars will be deleted from the beginning of the Bar you select here.
- Press the soft button above the number of bars.
- Use the data entry controls to select how many bars you want to delete.
- Press \*YES\* to complete the command, or press \*NO\* to cancel.

## Edit Track Page — Track Edit Functions

Pressing the Edit *Track* button displays the top level track editing page. Pressing the button twice will display the track edit options sub-page. These edit functions will affect the currently selected track. If a sequence is selected, the current sequence track will be edited; if a song is selected, the current song track will be edited.

The following functions can be selected from the Edit Track page:

- SHIFT — Shift track forward or back in time by a number of clocks.
- QUANTIZE — Auto-correct notes to the nearest beat.
- ERASE — Erase all or part of the track.
- COPY — Copy all or part of the track to another track in any sequence.
- TRANSPOSE — Raise or lower the pitch of all or part of the track by octaves and semitones.
- SCALE — Scale (increase or decrease the level of) one or more controller(s) in the track.
- EVENT-LIST — Provides a comprehensive event editor allowing you to locate and edit any event in the track.
- FILTER — This powerful function lets you remove, or copy to another track, any range of notes, controllers, program changes, etc.
- MERGE — Merge, or combine, the data from one track with another.

### Edit Track Range Page — Setting the Time and Key range

Within almost all track editing functions you will find a parameter labeled RANGE. Pressing the soft button below RANGE takes you to a special sub-page where you can define the time and key range over which the track edit command will work. Data outside the range will be left alone. When you select RANGE from within a track edit function, the display shows:

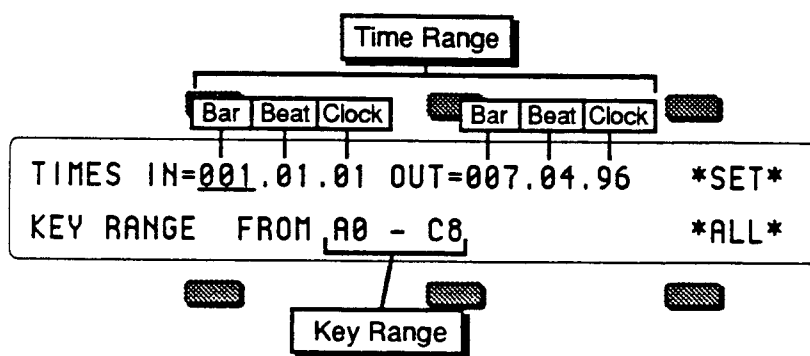

- On the upper line of the display you can select and modify the *Time* range which will be affected by the edit function; on the lower line you select and modify the *Key* range.
- To set the time range, first press the soft button above IN to choose the beginning edit time, shown in Bars, Beats and Clocks. Adjust to the desired bar with the data entry controls. Press the same soft button again to advance the underline from Bar to Beat to Clock, etc. adjusting each as needed. Then press the soft button above OUT and repeat these steps to set the ending edit time.
- To set the key range, press the soft button beneath the low and high keys, underlining the low key. Play the lowest note you want affected by the edit function; the underline switches to the high key. Play the highest key you want

to be affected. The underline disappears and the key range is set. (Note that you can also set the key range using the data entry controls, and pressing the soft button again to move the cursor from low to high key.)

- Press **\*SET\*** to accept these edit ranges for the current track edit function. You will be returned to the edit function with the display reading RANGE=SET.  
or;
- Or press **\*ALL\*** to bypass the edit ranges and have the track edit function affect the entire track. You will be returned to the edit function with the display reading RANGE=ALL.

**Important:** The IN and OUT times specified in the Edit Track Range page are the same as the Edit Times found on the Locate sub-page and used by the Autopunch function. They are interactive — changing the IN or OUT times in either location will cause them to be changed in the other.

### Track Edit Functions

- Press the *Edit Track* button. The display shows:

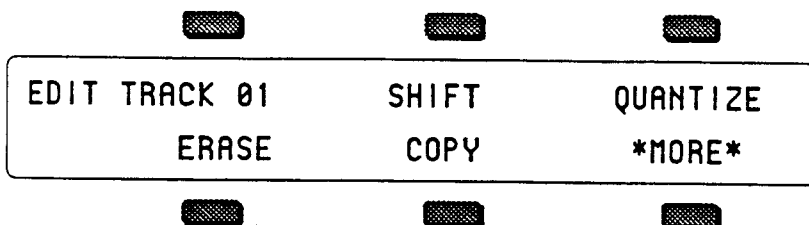

### SHIFT — Shift Track by Clocks

This command will cause all the events in the track to be moved ahead or back in time by a specified number of clocks (1 clock=1/96 quarter note). You can use this to create a "lazy" or "pushed" feel in a track.

- Make sure the track you want to edit is selected.
- Press *Edit Track*, then select SHIFT. The display shows:

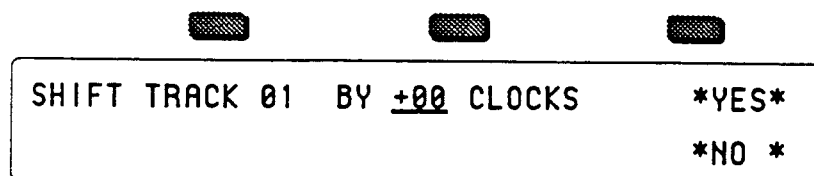

- Use the data entry controls to specify the amount the track is to be shifted. Positive values will move the events in the track ahead in time, toward the end of the sequence; negative amounts will shift the events back, toward the beginning. Range is -96 to +96, with 96 clocks representing one quarter note.
- Press **\*YES\*** to execute the edit command (or press **\*NO\*** to cancel). After editing, the VFX<sup>SD</sup> returns with the Play/Keep page where you can audition the results of the edit before deciding whether to keep it or not.

## QUANTIZE

The Quantize (or auto-correct) function can take a less than perfect track and put it right on the beat. The VFX<sup>SD</sup> uses post-quantization — that is, you first record a track, then apply the quantize later as a track editing option. You can select any note value up to 1/64 note triplets and move all notes in the track directly onto the nearest beat of that value.

- Make sure the track you want to quantize is selected.
- Press *Edit Track*, then select QUANTIZE. The display shows:

- Use the data entry controls to specify the note value to which the track is to be quantized. Available values are:
 

1/4 — quarter notes	1/16T — sixteenth note triplets
1/4T — quarter note triplets	1/32 — thirty-second notes
1/8 — eighth notes	1/32T — thirty-second note triplets
1/8T — eighth note triplets	1/64 — sixty-fourth notes
1/16 — sixteenth notes	1/64T — sixty-fourth note triplets
- If you wish to quantize a specific range rather than the entire track, press RANGE and set the time and/or key range on the Edit Track Range page, as shown earlier in this section. If not, leave it set to RANGE=ALL.
- Press \*YES\* to execute the edit command (or press \*NO\* to cancel). After editing, the VFX<sup>SD</sup> returns with the Play/Keep page where you can audition the results of the edit before deciding whether to keep it or not.

## ERASE

This command will erase notes, controllers and all other data from the entire track, or from a given range if you so specify.

- Make sure the track you want to erase is selected.
- Press *Edit Track*, then select ERASE. The display shows:

- If you wish to erase a specific range rather than the entire track, press RANGE and set the time and/or key range on the Edit Track Range page, as shown earlier in this section. If not, leave it set to RANGE=ALL.
- Press \*YES\* to execute the edit command (or press \*NO\* to cancel). After editing, if a range was specified the VFX<sup>SD</sup> returns with the Play/Keep page where you can audition the results of the edit before deciding whether to keep it or not. If the range was ALL, there is no audition.

## COPY

This command will copy all or part of the current track (the source track) to another track. The destination track can be in the same sequence or in a different sequence.

- Make sure the track you want to copy is selected.
- Press *Edit Track*, then select COPY. The display shows:

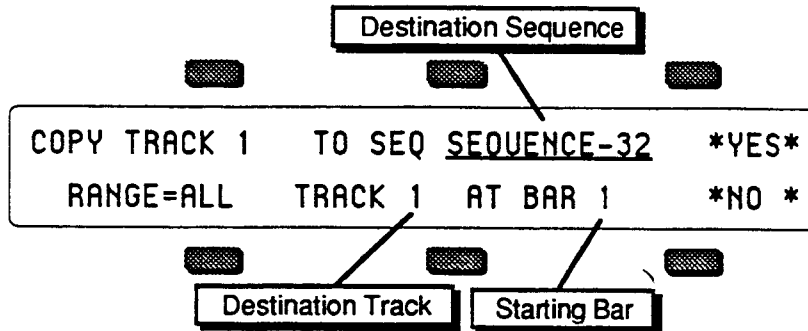

- If you want to copy the source track to a different sequence, select the destination sequence and use the data entry controls to choose the one you want. The default is the current sequence, the one the source track is in.
- Select the destination track and use the data entry controls to select a track for the source track to be copied into.
- Press the soft button beneath the destination track again to move the underline to the starting bar. The data from the source track will be copied into the destination track starting from the beginning of the bar specified here. The default is bar 1, the beginning of the track.
- If you wish to copy a specific range rather than the entire track, press RANGE and set the time and/or key range on the Edit Track Range page, as shown earlier in this section. If not, leave it set to RANGE=ALL.
- Press \*YES\* to execute the copy command (or press \*NO\* to cancel). After editing, the VFX<sup>SD</sup> returns with the Play/Keep page where you can audition the results of the edit before deciding whether to keep it or not.

**Note:**

The Copy Track function behaves differently depending on whether or not there is already recorded data on the destination track:

- If the destination track is empty (no track data), both the track data *and* all the track parameters (Volume, Pan, Timbre, etc.) from source track will be copied to the destination track.
- If the destination track already contains recorded track data, after you press \*YES\* to copy the track, the display will warn: DATA ON DESTINATION TRACK WILL BE LOST. Press \*YES\* to proceed, or press \*NO\* to exit and select a different destination track.
- After you press \*YES\*, the display asks COPY TRACK PARAMETERS TOO?
  - > Press \*YES\* to copy both the recorded track data *and* all the track parameters to the destination track.
  - > Press \*NO\* to copy only the recorded track data to the destination track, leaving the values of all the track parameters as they were before.

**\*MORE\* — Additional Track Edit functions**

Pressing \*MORE\* from the Edit Track page displays a sub-page which contains five additional track editing options. Pressing the *Edit Track* button twice will also take you directly to this page. Press \*MORE\*. The display shows:

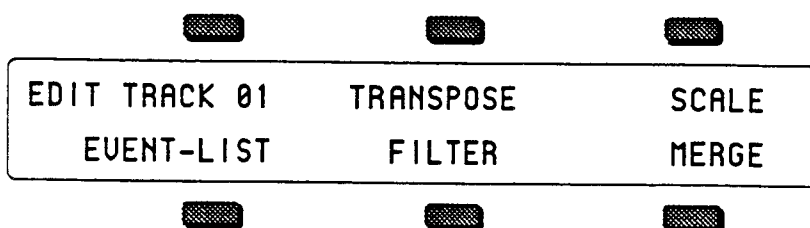

The track editing functions contained on this sub-page are as follows:

### TRANSPOSE

The Transpose function will raise or lower the notes in the track by a specified number of octaves and/or semitones. In addition to simply transposing the entire track, you can use the transpose function to re-map existing drum and percussion tracks for use with programs and instruments that have different key layouts, using the key range function to a transpose a single key.

- Make sure the track you want to transpose is selected.
- Press *Edit Track* twice (or press \*MORE\* from the Edit Track page), then select TRANSPOSE. The display shows:

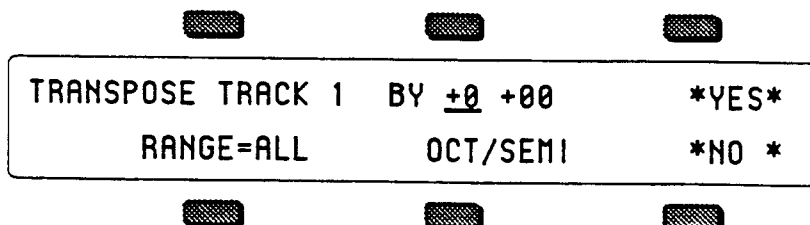

- Use the data entry controls to specify the amount the track is to be transposed:
  - > The first number (which is already selected) sets the octave amount. Range is -4 to +4 octaves.
  - > Press the soft button above the transpose amount again to move the underline to the semitone amount and adjust that. Range is -12 to +12 semitones.
- If you wish to transpose a specific range rather than the entire track, press RANGE and set the time and/or key range on the Edit Track Range page, as shown earlier in this section. If not, leave it set to RANGE=ALL.
- Press \*YES\* to execute the edit command (or press \*NO\* to cancel). After editing, the VFX<sup>SD</sup> returns with the Play/Keep page where you can audition the results of the edit before deciding whether to keep it or not.

### SCALE

The Scale command lets you increase or decrease the level of any controller information in the track by a specified amount. You could use this function, for example, to tame some over-zealous mod wheel work, or to increase the key velocity of all the notes in the track by some amount.

- Make sure the track you want to edit is selected.
- Press *Edit Track* twice (or press \*MORE\* from the Edit Track page), then select SCALE. The display shows:

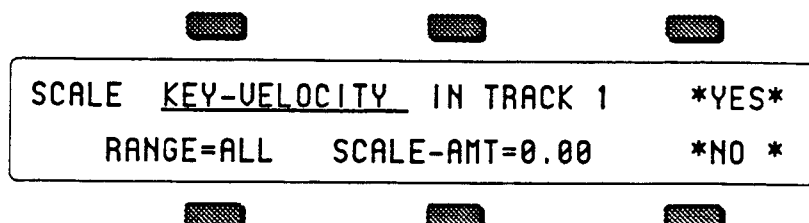



- Use the data entry controls to choose which type of controller(s) you would like to scale. The following event types can be scaled:
 

KEY-VELOCITY — Velocity	CNTL-72 RELS — Release Controller
CNTL-1 MODWHL — Mod Wheel	CNTL-XX XCNTL — Ext. Controller
CNTL-4 PEDAL — Foot Pedal	ALL CONTROLRS — All Controllers
CNTL-7 VOLUME — Volume Pedal	CHAN-PRESSURE — Channel (mono) Pressure
CNTL-64 SUSTN — Sustain Pedal	PITCH-BEND — Pitch Bend Wheel
CNTL-66 SOSTN — Sostenuto Pedal	MIXDOWN-VOLUME — Mixdown Volume
CNTL-70 PSEL — Patch Selects buttons	MIXDOWN-PAN — Mixdown Pan
CNTL-71 TIMBR — Timbre Controller	PITCH BEND — Pitch Bend Wheel
- If you wish to scale a specific range rather than the entire track, press RANGE and set the time and/or key range on the Edit Track Range page, as shown earlier in this section. If not, leave it set to RANGE=ALL.
- Press \*YES\* to execute the Scale command (or press \*NO\* to cancel). After editing, the VFX<sup>SD</sup> returns with the Play/Keep page where you can audition the results of the edit before deciding whether to keep it or not.

**EVENT-LIST**

The Event List function provides you with an extremely powerful tool for viewing and editing each event in the track. Every key event, controller change and program change can be individually located and edited.

- Make sure the track you want to edit is selected.
- Press *Edit Track* twice (or press \*MORE\* from the Edit Track page), then select EVENT-LIST. The display shows:

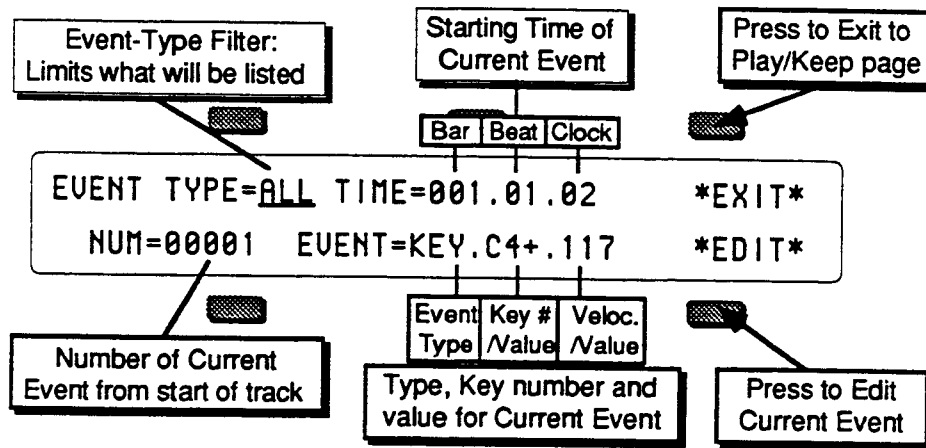

- **EVENT-TYPE FILTER** — This controls which types of events will be shown as you scroll up through the events in the track. When set to ALL, every event in the track will be listed. On the other settings, some types of events will be left out of the list — when the Event Number (below) is changed, the display will jump directly to the next event of the type shown, skipping other types.

Event Types which can be selected here are:

- |                              |                               |
|------------------------------|-------------------------------|
| MOD — Mod Wheel              | CNT — All Controllers         |
| PED — Foot Pedal             | PCH — Program Changes         |
| VOL — Volume Pedal           | MXV — Mixdown Volume          |
| SUS — Sustain Pedal          | MXP — Mixdown Pan             |
| SOS — Sostenuto Pedal        | PBN — Pitch Bend Wheel        |
| PSL — Patch Selects buttons  | KPS — Poly-Key Pressure       |
| TMB — Timbre Controller      | CPS — Channel (mono) Pressure |
| RLS — Release Controller     | KEY — Key events only         |
| XCC — XCTRL; Ext. Controller | ALL — All Events              |

- **TIME** — Shows the current time in terms of Bar, Beat and Clock. These three **TIME** fields can be individually selected by repeated presses of the soft button. This allows you use the up and down arrows to step ahead or back in time by bars, beats or clocks, depending on which field is selected.
- **NUM** — Event Number. When this field is selected, you can use the data entry controls to step ahead or back in time among the events in the track to find the one(s) you want to edit. When you press the up arrow button, it will advance to the next event of the type specified in Event Type. Moving the data entry slider will scroll quickly through all the events in the track. You will hear the notes in the sequence play as you step through the track.
- **EVENT** — This shows the type and value of the current event. The first segment of this readout is always the Event Type. For Key Events and Poly-Key pressure events there are two additional segments; for all other event types there is one additional part:
  - > On Key Events, the display looks like: **EVENT=KEY.C4.115**.  
The three segments represent Event Type; Key Number, and Velocity.
  - > On Poly-Key Pressure Events, the display shows **EVENT=KPS.C4.115**.  
The three segments represent Event Type; Key Number, and pressure Value.
  - > For all other Event types the display shows, for example, **EVENT=MOD.124** where the two segments represent the Event Type and the Value.
  - > Time locations with no event are shown as **EVENT=\*\*\*.000**.
- **\*EXIT\*** — This exits Event List mode. If you have made any changes to the track you will be put on the Play/Keep page where you can audition the changes before deciding whether to keep them.
- **\*EDIT\*** — Pressing **EDIT** displays the event editor sub-page which shows the selected event and its event number with the time that it occurs, and in the case of events with duration, the end time of the event as well.

Once you have selected an event to edit using the Event Number parameter, press **\*EDIT\***. The display shows:

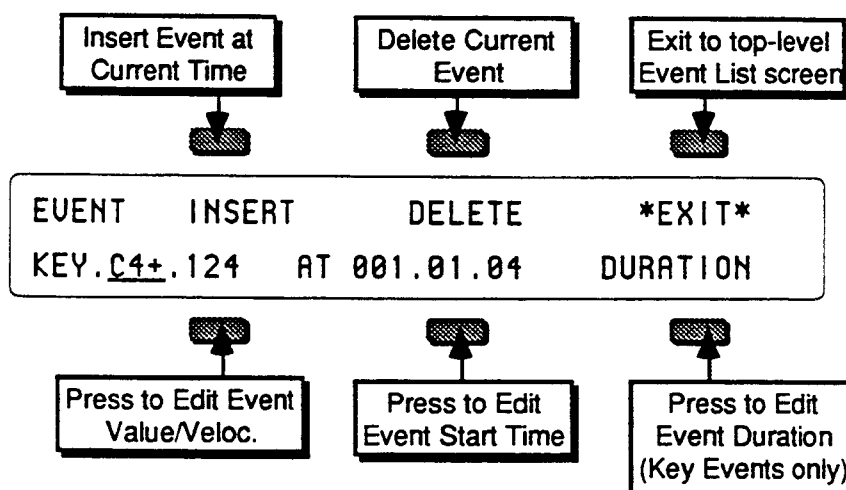

- **INSERT** — Pressing **INSERT** will insert an event of the current Event Type at the time showing on the display. This option is not available when the Event Type is **ALL** (all events) or **CNT** (all controllers).
- **DELETE** — This will remove the current event from the track.
- **\*EXIT\*** — Pressing **\*EXIT\*** returns you to the main Event List page.

- To edit the VALUE of the current Event (the key number and velocity of a key event; the value from 0 to 127 of a controller change; or a program change number, etc.) press the lower-left soft button to select the value, then use the data entry controls to change it. For Key events and Poly-Key pressure events, pressing the soft button again will select the second value segment for editing.
- To change the STARTING TIME of the current event, press the soft button below the time. The display shows:

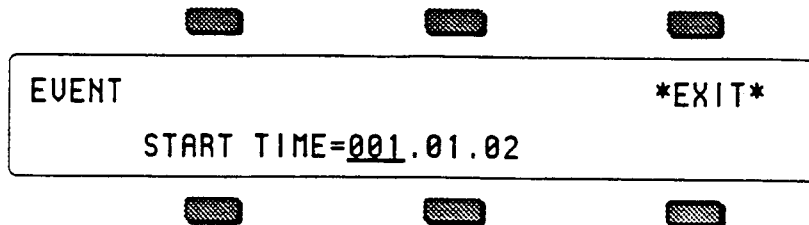

Use the data entry controls to change the start point of the event, pressing the soft button beneath the time to move the cursor between Bar, Beat and Clock. When you have the starting time that you want showing on the display, press \*EXIT\* to return to the Event List page with the event on the new time.

**Note:**

When a Song track is selected, an additional two segments are added to this readout, and the time readouts on the other Event List pages. In song mode the display shows Step.Rep.Bar.Beat.Clock.

For example, Step 1, Rep 2, Bar 4, Beat 3, Clock 76 would appear as:

START TIME=01.02.004.03.76

- DURATION — For Key Events only, you can change the length of the event (the time between when the key is struck and it is released). From the Event Edit sub-page press the soft button below DURATION. The display shows:

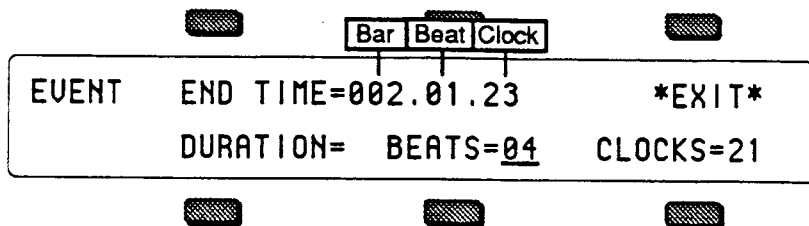

On the upper line of the display you can edit the end time of the event, using the data entry controls to change the end point and pressing the soft button above the time to move the cursor between Bar, Beat and Clock.

On the lower line of the display you can edit the actual duration of the event, expressed in terms of how many beats and clocks the event lasts. You can select BEATS=##, edit that and then select CLOCKS=## and edit that.

The upper and lower lines of this sub-page are interactive — editing the End Time on the upper line will cause the duration on the lower line to change, and vice versa.

When you have the duration that you want showing on the display, press \*EXIT\* to return to the Event Edit Sub-page.

**Auditioning Event Edit changes**

If you press \*EXIT\* to leave the Event List function without having made any changes in the track, you will simply be returned to the Edit Track page.

If you do change anything in the the track, when you press \*EXIT\* you will be placed on a special version of the Play/Keep page, where you can audition the new track and the original before deciding to either keep the new track, keep the old track *or* return to the Event Editor to edit some more. The display shows:



- Press **KEEP ORIGINAL** to exit to the Edit Track page, leaving the track as it was before you began editing.
- Press **KEEP NEW** to save the changes you have made to the track in Event List mode, replacing the original track in memory. Or,
- Press **EDIT EVENTS** to re-enter the Event List mode with the changes you have made so far intact, but retaining the option of keeping the original track later on.

## FILTER

The Filter command can be used to selectively remove events (such as notes, controllers and program changes) from a track, or to copy selected events to a different track for further editing. The Filter command has two modes, Erase and Copy. Depending on which mode is selected, it will either remove the specified events from the track, or simply copy them to another track, leaving the original track intact.

- Make sure the track you want to filter is selected.
- Press *Edit Track* twice (or press \*MORE\* from the Edit Track page), then select FILTER. The display shows:

```

      [ ]      [ ]      [ ]
  FILTER CNTL-1 MODWHL FROM TRACK 1 *YES*
      RANGE=ALL  MODE=ERASE      *NO *
      [ ]      [ ]      [ ]
  
```

- Use the data entry controls to choose which type of events you would like filtered from the track. The following event types can be filtered:
 

CNTL-1 MODWHL — Mod Wheel	ALL CONTROLRS — All Controllers
CNTL-4 PEDAL — Foot Pedal	CHAN-PRESSURE — Channel (mono) Pressure
CNTL-7 VOLUME — Volume Pedal	MIXDOWN-VOLUME — Mixdown Volume
CNTL-64 SUSTN — Sustain Pedal	MIXDOWN-PAN — Mixdown Pan
CNTL-66 SOSTN — Sostenuto Pedal	KEY-PRESSURE — Poly-Key Pressure
CNTL-70 PSEL — Patch Selects buttons	PITCH-BEND — Pitch Bend Wheel
CNTL-71 TIMBR — Timbre Controller	PROGRAM-CHNG — Program Changes
CNTL-72 RELS — Release Controller	KEY-EVENTS — Notes only, no controllers
CNTL-XX XCNTL — Ext. Controller	
- If you wish to filter a specific range rather than the entire track, press RANGE and set the time and/or key range on the Edit Track Range page, as shown earlier in this section. If not, leave it set to RANGE=ALL.
- Press MODE=ERASE. This displays a special sub-page where you select the Filter Mode:

```

      [ ]      [ ]      [ ]
  FILTER CNTL-1 MODWHL FROM TRACK *COPY *
      COPY TO TRACK 2      *ERASE*
      [ ]      [ ]      [ ]
  
```

- > If you want to copy the data to another track, select a destination track and then press COPY. You are returned to the Filter page, the display reading MODE=COPY.
- > If you want to permanently remove the data from the track, simply press ERASE. You are returned to the Filter page, the display reading MODE=ERASE. (Note that Erase mode is the default whenever you enter the filter command, so if you want Erase mode you can skip this step.)

- Press **\*YES\*** to execute the filter command (or press **\*NO\*** to cancel). After editing, the VFX<sup>SD</sup> returns with the Play/Keep page where you can audition the results of the edit before deciding whether to keep it or not.

**Note:** If you chose Copy mode, the VFX<sup>SD</sup> returns with the new track (the copy) selected. If you wanted to copy and then erase the data, you must first re-select the original track and then repeat the above procedure, using Erase mode.

## MERGE

This command will take the data in the selected track and merge, or combine, it together with that of another track. The destination track can be in the same sequence or in a different sequence from the source track. Note that the source sequence is not altered or erased by this process.

- Make sure the track you want to merge (the source track) is selected.
- Press **Edit Track** twice (or press **\*MORE\*** from the Edit Track page), then select **MERGE**. The display shows:

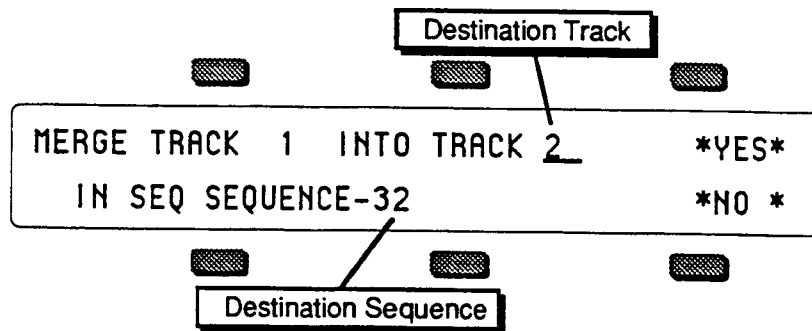

- Press the soft button above the destination track and use the data entry controls to select a track for the source track to be merged into.
- If you want to merge the source track with a track in a different sequence, select the destination sequence and use the data entry controls to choose the one you want. The default is the current sequence, the one the source track is in.
- Press **\*YES\*** to execute the merge command (or press **\*NO\*** to cancel). After editing, the VFX<sup>SD</sup> returns with the Play/Keep page where you can audition the results of the edit before deciding whether to keep it or not.

## Section 13 — Sequencer Applications

This section covers a number of advanced sequencer applications, including using the VFX<sup>SD</sup> with a variety of external MIDI devices.

Using the VFX <sup>SD</sup> with a Drum Machine . . . . .	13 - 1
Song Position Pointers . . . . .	13 - 2
MIDI Song Selects . . . . .	13 - 2
MIDI Controller Tricks — Creating Template Sequences . . .	13 - 2
MULTI Mode — Receiving on up to 12 MIDI channels . . .	13 - 4
A Few Important Points About Multi Mode . . . . .	13 - 4
Using the VFX <sup>SD</sup> with an External MIDI Sequencer . . . . .	13 - 5
Using The VFX <sup>SD</sup> with a MIDI Guitar Controller . . . . .	13 - 6

### Using the VFX<sup>SD</sup> with a Drum Machine

When you use the VFX<sup>SD</sup> in conjunction with a drum machine or other rhythm sequencer, there are basically three ways to go:

- 1) Sync the drum machine's clock to the VFX<sup>SD</sup>;
- 2) Sync the VFX<sup>SD</sup>'s clock to the drum machine; or
- 3) Sequence the drum machine from the VFX<sup>SD</sup>, just as you would a synthesizer.

To Sync a Drum Machine to the VFX<sup>SD</sup>:

- Connect the MIDI Out of the VFX<sup>SD</sup> to the MIDI In of the drum machine.
- Set the drum machine to sync to MIDI clocks.
- Set the drum machine to receive on an unused MIDI Channel, OMNI Off; or disable Channel information. You don't want the drum machine playing VFX<sup>SD</sup> sequence data intended for other instruments. MIDI Clocks, Start, Stop and Continue are *Real Time* commands, and are sent and received regardless of MIDI channel or mode.
- The drum machine should now sync to the VFX<sup>SD</sup>'s clock. Pressing *Play* or *Stop/Cont* will Start, Stop and Continue the drum machine, assuming it receives those commands.

To Sync the VFX<sup>SD</sup> to a Drum Machine:

- Connect the MIDI Out of the drum machine to the MIDI In of the VFX<sup>SD</sup>.
- Set the VFX<sup>SD</sup> to sync to MIDI clocks. On the Seq Control page, select **CLOCK=MIDI**.
- Set the drum machine to not send channel info, or to send on a MIDI Channel that is not being used by any of the VFX<sup>SD</sup> tracks. Again, MIDI Clocks, Start, Stop and Continue are sent and received regardless of MIDI channel or mode.
- The VFX<sup>SD</sup> should now sync to the drum machine's clock. Starting, Stopping or Continuing the drum machine will Start, Stop and Continue the VFX<sup>SD</sup>.

To Sequence a Drum Machine from a Track of the VFX<sup>SD</sup>:

- Connect the MIDI Out of the VFX<sup>SD</sup> to the MIDI In of the drum machine.
- Set the drum machine to Tape Sync or External Clock, or any setting other than Internal or MIDI Clock. This way it will not play it's own patterns, but will act only as a sound-producing device, sequenced from a track of the VFX<sup>SD</sup>.
- Set the drum machine to POLY (OMNI Off) mode, and select a MIDI Channel.
- From the Performance MIDI Page, assign a track on the VFX<sup>SD</sup> MIDI Status, and set it to the same MIDI Channel you assigned the drum machine.
- You should now be able to play the drum machine from the VFX<sup>SD</sup> keyboard. You can then record a track on the VFX<sup>SD</sup>, from the VFX<sup>SD</sup> keyboard, which

will play on the drum machine — just as if you were sequencing an external synthesizer. The advantage of this approach is that some drum machines respond better to velocity when played from MIDI than when played from their own front panels. Thus you may get more dynamic range out of your drum machine if you use this approach. The disadvantage is that you use up VFX<sup>SD</sup> sequencer memory to sequence the drum machine.

### Song Position Pointers

The VFX<sup>SD</sup> sends and receives Song Position Pointers via MIDI. Song Position Pointers are MIDI commands that tell a sequencer or drum machine where to locate within a song or sequence.

When the VFX<sup>SD</sup> receives a Song Position Pointer, it will locate to the appropriate place in the selected song or sequence.

The VFX<sup>SD</sup> sends a Song Position Pointer over MIDI whenever you use the Auto-Locate control (the GOTO function on the Locate Page). Any receiving unit which recognizes Song Position Pointers will locate to the same spot. (Not all devices recognize Song Position Pointers. Consult the manual of any other sequencing device you are using, to see if it does.)

### MIDI Song Selects

MIDI Song Selects allow a sequencer such as the VFX<sup>SD</sup> to instruct a remote sequencer or drum machine to select a new song whenever you select a Sequence or Song on the VFX<sup>SD</sup>. The VFX<sup>SD</sup> will always send Song Selects. Whether or not it receives them depends on the setting of the SONG-SEL parameter on the MIDI Control sup-page.

The VFX<sup>SD</sup> transmits and receives MIDI Song Selects in Sequence Mode as well as Song Mode (depending again on the setting on the SONG-SEL parameter). This allows you to select any VFX<sup>SD</sup> sequencer location from a remote sequencer, computer or drum machine, and vice versa. They are set up as follows:

MIDI Song Selects # 00-59 will select VFX<sup>SD</sup> Sequencer locations # 00-59.

Conversely, selecting Sequencer locations # 00-59 will cause the VFX<sup>SD</sup> to send MIDI Song selects # 00-59

### MIDI Controller Tricks — Creating Template Sequences

There are some subtle features of the VFX<sup>SD</sup> sequencer which enhance its capabilities as a MIDI controller. You can, among other things, change the program and volume of every instrument in your rig with the push of a button, and create giant presets with as many as 12 MIDI devices split and/or layered. Each sequence you create and store in the VFX<sup>SD</sup>'s sequencer memory contains up to 12 sets of Program and Volume information, each of which will be sent out on the designated MIDI Channel when you select that sequence. Each sequence also remembers *all* Performance/Track parameters for each track, as well as which tracks are selected or layered.

If you have the VFX<sup>SD</sup> connected to other instruments via MIDI, try this:

- Press *Seq*, and select a -BLANK- location to create a new sequence. Name this sequence MIDI-OUT-1, or something similar, to indicate that it is specially set up as a MIDI controller template.



- Press the *Tracks 1-6* button, and select the first track.
- Press *MIDI*, and set the track's STATUS to MIDI; on the second sub-page set the CHANNEL to the MIDI channel of one of your remote MIDI instruments; on the third sub-page, select a program for the instrument.
- Press *Tracks 1-6*, select another UNDEFINED track, and repeat the above steps, setting this track up to drive a different instrument. And so on, until you have one track playing each external instrument. Create a couple of LOCAL tracks with different programs too. Selecting one of them will let you play the VFX<sup>SD</sup> only. Selecting any of the MIDI tracks will let you play the receiving instrument that is set to the same MIDI channel as that track.
- You see that from the Tracks 1-6 or 7-12 pages, you can change what plays from the VFX<sup>SD</sup> keyboard simply by selecting different tracks. You can layer tracks together by double-clicking their soft buttons. You can adjust the volume, key range, transpose, etc. for any of the tracks.
- Now create another sequence. (The VFX<sup>SD</sup> will ask you "SAVE CHANGES TO <SEQ NAME>?" Answer \*YES\*.) Name this sequence MIDI-OUT-2. For the tracks of the new sequence, go through the same procedure as before, but assigning different program numbers to the external instruments. (Remember always to change programs from the VFX<sup>SD</sup>'s MIDI sub-page.)
- Again, you can play a different external instrument, or the VFX<sup>SD</sup> alone, or the VFX<sup>SD</sup> and an external instrument, depending on which track(s) you select.

Now press *Seq* and reselect the first sequence. (Again, the VFX<sup>SD</sup> will ask you "SAVE CHANGES TO <SEQ NAME>?" Answer \*YES\*.) Notice when you select the new sequence that all the external instruments connected to the VFX<sup>SD</sup> change to the proper program for that sequence — each track sent out a program change on its MIDI channel when the sequence was selected. Now select the second sequence again. Each external instrument again changes back to the proper program.

Notice that you haven't recorded anything on either of these sequences. They exist merely as *Templates*, which serve two useful purposes when using the VFX<sup>SD</sup> as a system controller:







- 1) Every time you select a new sequence, each track can send a program change to an external instrument. You can change the sound that every synth in your rig is playing with one press of a button. Also the same tracks will be selected or layered as when you last saved the sequence.
- 2) When you select any track of a sequence, the VFX<sup>SD</sup> keyboard plays whatever program is on that track, or sends on the track's MIDI channel, or both. Select a different track and you have a different configuration. From the Tracks 1-6 and 7-12 pages you select any combination of local and MIDI sounds.

Of course you can record data on any of these sequences if you want. Whether you do or not, they will work as templates. You can play external instruments from the VFX<sup>SD</sup> or from their own keyboards. You can have a track send a program change to a MIDI digital delay or reverb unit; have it send program changes to a sampler to load sounds, or to a drum machine to change patterns, just by selecting a new sequence. No doubt you will come up with some applications of your own, based on your equipment and your needs.

**MULTI Mode — Receiving on up to 12 MIDI channels**

When you select MIDI MODE=MULTI on the MIDI Control Page, the 12 tracks of the current sequence or song become like 12 "virtual instruments," each receiving independently on its own MIDI channel, but all sharing the same 21 voices and the same effects set-up.

- Press **MIDI Control**. Select MIDI In mode (MODE=\_\_\_\_\_) and set to MULTI. The 12 tracks of the current sequence will now each receive on its own MIDI channel, which you can select independently for each track.
- Create a new sequence. You might want to name this sequence "MULTI IN", or something similar, to indicate that it is specially set up as a multi-channel MIDI receiver.
- Press **Tracks 1-6**. All the tracks except the first are still UNDEFINED. Select each of the tracks, defining them and putting the current program on them. Press **Tracks 7-12** and do the same for the 6 tracks there. Then press **Tracks 1-6** again to return to the first 6 tracks.
- Press the **MIDI** button in the Performance section. The first sub-page, labeled STATUS, shows the status for the six tracks — Local, MIDI, Both or \*EXT\*.
- Press **MIDI** again to reveal the second sub-page, labeled CHANNEL. Here you select the MIDI channels for the different tracks:

			
CHAN	01	<u>02</u>	03
	04	05	06
			

Select any track and set it to receive on the MIDI Channel you wish. Now, as long as the VFX<sup>SD</sup> is in MULTI Mode, incoming MIDI information on that channel will be received by that track. Incoming MIDI program changes will change the program on the track. Incoming MIDI volume messages will adjust the level of the track. Press **Tracks 7-12** and do the same for the 6 tracks there

If (as is often the case) you don't want all 12 MIDI channels to receive, press **MIDI** until you return to the Status sub-page and set the track(s) you want to disable to \*EXT\*. Any tracks set to \*EXT\* will not respond to incoming MIDI (though they will send MIDI when played from the VFX<sup>SD</sup> keyboard).

- Press the SEQ Button to go to the Sequencer Bank page, and select the same sequence again (press the soft button above or below the sequence location that's already underlined). The display will ask "SAVE CHANGES TO <SEQ NAME>." Answer \*YES\*. This saves the track assignments you made. You might want to save this sequence to disk for future use.
- You don't need to record anything on this sequence — just leave it as a template for receiving on up to 12 different MIDI Channels. Whenever you want the VFX<sup>SD</sup> to act as a multi-channel MIDI receiver, just load or select this same sequence.

**A Few Important Points About Multi Mode**

- When the VFX<sup>SD</sup> is in Multi mode, *only* the 12 tracks of the Multi will receive MIDI information. Sounds and presets selected in the normal fashion will not respond to MIDI at all.

- Each of the 12 sequencer tracks (six in Tracks 1-6, six in Tracks 7-12) is completely independent and polyphonic. The VFX<sup>SD</sup>'s *Dynamic Voice Assignment* means each track can have up to all 21 voices if it needs them. If all 21 voices are in use and a track needs a voice, it will "steal" the voice from the oldest note (or the one with the lowest voice priority).
- The 12 tracks respond independently to MIDI program changes, allowing you to assign a new sound to a track via MIDI. The selected program's effect does not normally come with it — all of the 12 tracks in the sequence or song share the same effects setup, which can normally be changed only by editing the effect from within sequence (see Sequencer, Section 4).
- You can, however, cause a sound's effects set-up to become the sequence effect (which will then be applied to all 12 tracks) by sending program change # 125 immediately before the program change which selects the new sound for the track (see "Receiving Program Changes," Section 6).
- Only one track can receive on a given MIDI Channel. If two (or more) tracks are set to the same MIDI Channel, the lower-numbered track will receive on that channel and any higher-numbered track(s) set to the same channel will not receive at all.
- You may not want all 12 Tracks to receive. Tracks that you leave in the UNDEFINED state will not receive any MIDI data. Just define as many tracks as you need. Or set some tracks to \*EXT\* on the Performance MIDI page. Tracks set to \*EXT\* will not respond to incoming MIDI data.

### Using the VFX<sup>SD</sup> with an External MIDI Sequencer

For optimal results when using it with an external multi track sequencer, the VFX<sup>SD</sup> should be set up as described above to receive in Multi Mode, and the 12 tracks of the current sequence assigned to receive on the desired MIDI channels.

The illustration below shows a typical configuration for using the the VFX<sup>SD</sup> with an external MIDI sequencer in MULTI Mode:

MODE=MULTI

Track 1 Chan=1  
Track 2 Chan=2  
Track 3 Chan=3  
Track 4 Chan=4  
Track 5 Chan=5  
Track 6 Chan=6  
Track 7 Chan=7  
Track 8 Chan=8  
Track 9 Chan=9  
Track 10 Chan=10  
Track 11 Chan=11  
Track 12 Chan=12

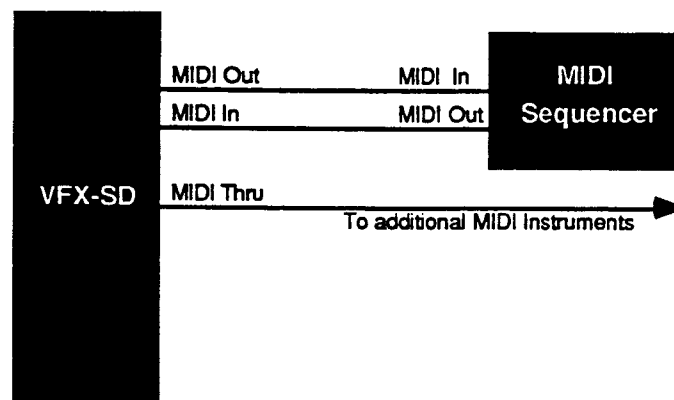

The 12 tracks of the current sequence keys, volume, controllers and program changes independently.

Note that the MIDI channel assignments shown above are merely default values. You can set any of the 12 tracks to receive on any of the 16 available MIDI

channels (though, as mentioned above, only one track will receive on a given channel). Also, you can turn a track's Status to \*EXT\* (so that it does not receive incoming MIDI at all) if you want less than 12 channels to be recognized by the VFX<sup>SD</sup>.

When using the VFX<sup>SD</sup> as both the controller and one of several sound generators with an external sequencer:

- Set up the MIDI connections as shown in the diagram on the previous page.
- Set the external sequencer to echo incoming MIDI data at its output.
- Press *Master* three times and set the MIDI-TRK-NAMES parameter to ON. When this parameter is ON you will see the name of the sound on a track (instead of \*MIDI-CHAN-##) when the track's status is MIDI.
- Press Tracks 1-6 or Tracks 7-12 and set up your tracks for sequencing:
- For tracks which you want to play a VFX<sup>SD</sup> sound, set the Status to MIDI. The track will send MIDI to the sequencer, and then will play local VFX<sup>SD</sup> voices when it receives the information back at its MIDI input.
- For tracks which you want to play one of the other MIDI instruments, but *not* play a VFX<sup>SD</sup> sound, set the Status to \*EXT\*. The track will send MIDI to the sequencer, but will not play locally when the data is received. The MIDI Thru jack will send the information along to the remote instruments.

### Using The VFX<sup>SD</sup> with a MIDI Guitar Controller

The VFX<sup>SD</sup> makes an ideal voice module to use with any MIDI Guitar Controller which is capable of sending in MONO Mode. MONO Mode (MIDI Mode 4) allows a guitar controller to send the notes played on each string on a different MIDI Channel. This has the advantage of letting each string send pitch bends independently, which is the only way to truly recreate guitar technique on a synthesizer.

Some earlier guitar synths do not support MONO mode. You will have to consult the manual of your particular model to see if it does. If you have a guitar synth which only sends in POLY Mode (i.e. sends all six strings on the same MIDI Channel) you should use the VFX<sup>SD</sup> in POLY Mode (or OMNI Mode) and set the guitar controller to send on the MIDI Channel that is selected for the Base Channel on the MIDI Page.

For MIDI Guitar Controllers which do support MONO Mode, the VFX<sup>SD</sup> provides two types of MONO mode reception. The first is MONO A Mode, which is a simple and straightforward way of using MONO mode without getting involved with tracks or other complications:







- Connect the MIDI Out of the guitar controller (or its MIDI converter) to the MIDI In of the VFX<sup>SD</sup>.
- Set your guitar controller to send in MONO Mode on Channels 1-6. (Some models have an easy shortcut for getting into this state.)
- On the MIDI Control page, set the Base MIDI Channel to BASE-CHAN=01.
- Also on the MIDI Control page, set the MODE parameter to MODE=MONO A. This sets up the VFX<sup>SD</sup> to respond monophonically to 12 consecutive MIDI channels starting from the Base Channel (Consult Section 6 for a more complete description of MONO Mode.)

You can now select sounds or presets on the VFX<sup>SD</sup>, either from the front panel or from MIDI program changes, and the guitar controller will play those sounds

exactly as if they were played from the keyboard.

If you are a little more adventurous, and would like the flexibility to put a different sound program on every string of the guitar, you can use MONO B mode, in which each track of the current sequence receives monophonically on its own MIDI channel, and can receive program changes independently. Where MONO A is like POLY mode with monophonic reception, MONO B is just like MULTI mode, except that each track is monophonic.

- Press **MIDI Control**. Set the MIDI In mode to MODE= MONO B. The 12 tracks of the current sequence will now each receive monophonically on its own MIDI channel
- Create a new sequence. You might want to name it "MONO-B IN", or something similar, to indicate that it is specially set up for this type of reception.
- Press **Tracks 1-6**. All the tracks except the first are still UNDEFINED. Select each of the six tracks, defining them and putting the current program on them. You can leave Tracks 7-12 undefined.
- Press **MIDI** twice to go to the MIDI CHANNEL sub-page. Here you select the MIDI channels for the different tracks:

			
CHAN	01	<u>02</u>	03
	04	05	06
			

The default values are as shown above. If you want to receive on a different set of MIDI channels, select each track and edit it accordingly. Unlike MONO A, in this mode the consecutive channel assignments are not automatic. You must set the tracks to six consecutive channels.

Now you're ready to play. A few things to bear in mind:

- Notes played on each string will play only the corresponding track. Each string/track combination is totally independent.
- You can change the program for each track manually from the VFX<sup>SD</sup>'s front panel (using the Replace Program function) or by sending Program Changes from the controller via MIDI.
- Each track will accept Program Changes independently. In many cases you will want to have the guitar controller send the same-numbered Program Change on all six channels so that all six strings play the same sound. You can, however, send the VFX<sup>SD</sup> a different Program Change for each track. You could use this effect to have, for example, a bass sound play on the bottom two strings and a piano sound on the top four. Or if you are feeling experimental you could play a different sound on each string.
- It's a good idea to set up and save to disk a special template sequence, as described above, which you always use in conjunction with the guitar synth. That way you won't accidentally change the programs in the tracks of an existing sequence.
- If your guitar synth can send certain MIDI controllers on their own MIDI Channels, have it send any controllers you want to affect all the tracks (such as the "whammy bar") on the Base-Channel-minus-1. When the Base Channel is 1, Global controllers should be sent on Channel 16.



## Appendix A

### VFX<sup>SD</sup> MIDI Implementation Specification - version 2.00

#### 1 Introduction and Overview

This section describes the MIDI System Exclusive (SysEx) communication protocol used when the VFX<sup>SD</sup> is communicating with an external computer (EXT). The protocol is designed to aid the implementation of editing programs running on EXT, and so this information is especially relevant to designers and programmers of editing programs. The commands described here allow editor/librarian programs to collect and alter information about presets, programs, and the tracks within the VFX<sup>SD</sup>.

##### 1.1 Universal System Exclusive Device Inquiry Message

The VFX<sup>SD</sup> supports the MIDI Device Inquiry message which allows instruments and computers to ascertain the identity of the unit(s) to which they are connected via MIDI. The VFX<sup>SD</sup> responds to the following Identity Request message by sending an Identity Reply message. The VFX<sup>SD</sup> will respond to the inquiry if the channel information in the message contains either the base MIDI channel of the VFX<sup>SD</sup> or the all channel broadcast code (\$7F).

11110000	F0	System Exclusive status byte
01111110	7E	Non Real Time message code
0000nnnn	0x	Base MIDI channel number
or		
01111111	7F	All Channel Broadcast code
00000110	06	General Information message code
00000001	01	Identity Request message code
11110111	F7	End of System Exclusive

##### 1.2 System Exclusive Device Identity Reply Message

The following Identity Reply message contains information about the VFX<sup>SD</sup>, and is transmitted in response to an Identity Request.

11110000	F0	System Exclusive status byte
01111110	7E	Non Real Time message code
0000nnnn	0x	Base MIDI channel number
00000110	06	General Information message code
00000010	02	Identity Reply message code
00001111	0F	ENSONIQ manufacturer's Code
00000101	05	VFX Product Family ID code - LSByte
00000000	00	VFX Product Family ID code - MSByte
00000000	01	VFX <sup>SD</sup> Family Member (Model ID) code LSByte
00000000	00	VFX <sup>SD</sup> Family Member (Model ID) code MSByte
00000000	00	Software revision information
00000000	00	(not used)
0nnnnnnn	NN	Major Version Number (integer portion)
0nnnnnnn	NN	Minor Version Number (decimal fraction portion)
11110111	F7	End of System Exclusive

#### Note:

The VFX<sup>SD</sup> Version II Family Member (Model ID) code LSByte = 02 to identify the new model. This difference is only in this Identity Reply message; all other messages have the standard VFX<sup>SD</sup> header information.

## 2 MIDI System Exclusive Packet Pieces

A packet is a bunch of information, i.e. a message, in the form of a MIDI data stream. Each packet can be divided into three sections or pieces. The first and last packet pieces form the *frame* for a message. The message contains the commands described in section 3. Every message must be preceded with a SysEx head and followed with a SysEx tail. A complete packet looks like this:

SysEx Head . . . . . Message . . . . . SysEx Tail

### 2.1 MIDI System Exclusive Packet Head

This is the common MIDI system exclusive header which must be used on all system exclusive messages to and from the VFX<sup>SD</sup>. These six bytes are always sent preceding the message portion of the packet. The VFX<sup>SD</sup> Model ID Code in this header is different from the VFX<sup>SD</sup> Family Member (Model ID) code in the Device ID message in order to allow transfer of common messages between a VFX and a VFX<sup>SD</sup>. All messages which are not common to both machines will be ignored.

11110000	F0	System Exclusive status byte
00001111	0F	ENSONIQ Code
00000101	05	VFX Family ID Code
00000000	00	VFX <sup>SD</sup> Model ID Code
0000nnnn	0x	Base MIDI channel number
00000nnn	0x	Message Type (see section 3)

### 2.2 MIDI System Exclusive Packet Tail

For every head there is a tail. The tail follows the message portion, and is the last byte of every complete SysEx packet.

11110111	F7	End of System Exclusive
----------	----	-------------------------

### 2.3 Message Format

The VFX<sup>SD</sup> message format within the packet frame allows 8 bit data bytes to be transmitted and received using the 7 bit data of MIDI. The MSB of the data bytes must always be a zero, so the bytes are converted to two 4 bit nybbles. These nybbles are converted to bytes whose upper four bits are all zero for transmission. This is a description of the format of all data bytes within the packet frame as they are transmitted or received via MIDI. The details of each message are given in section 3.

0000HHHH	H = Hi 4 bits of data byte - transmitted first
0000LLLL	L = Lo 4 bits of data byte

This represents how the 8 bit byte HHHLLLLL would be transmitted.

### 2.4 Receiver Errors

If the message received by the VFX<sup>SD</sup> is not understood, then an informative error message will be displayed and an error message will be sent as described in section 3.2. Errors typically occur when the MIDI cable is accidentally unplugged during a long dump message such as an All Programs Dump message. If EXT cannot handle the error message, then the displayed message will prompt the user to retransmit the original message after re-connecting the MIDI cable or otherwise correcting the cause of the error.



### 3 Message Type List

The next few sections describe the messages to be used between EXT and VFX<sup>SD</sup>. The message type corresponds to the last byte of the system exclusive packet head described in section 2.1.

*Note: The SysEx messages outlined below appear as an ordered description of bytes which do not necessarily represent the MIDI format described in section 2.3. Remember, full 8-bit data bytes are always sent as two "nybble-ized" bytes. Message types are part of the head and are sent as bytes, but Command types are considered data and are sent as two nybbles.*

#### 3.1 Command Messages (Message Type = 00)

All messages which need some interpretation by the receiver are called *command messages*. Every command message is transmitted using the message format described in section 2.3. The first byte of each command message is the command type byte, which follows the message type byte in the packet head. The command type is shown in the section headings.

##### 3.1.1 Virtual Buttons (Command Type = 00)

EXT can simulate button presses from the front panel of the VFX<sup>SD</sup> by sending this command. Sending the listed button numbers in a command will simulate a single button down being held *down*. Button *up* commands add an offset of 96 to the the button down numbers. The button number follows the command type byte in the message. Remember to send a button up command for every button down command that is sent. Button up commands were implemented in version 2.01 and above. *Note: a delay of 2-300 msec between button commands, or at least pairs of button commands, is recommended.*

##### 3.1.1.1 Button Numbers

*Standard VFX button numbers:*

Logical Number	Front Panel Button Name	Logical Number	Front Panel Button Name
0	unnamed bank 0	29	Wave
1	unnamed bank 1	33	Pitch
2	unnamed bank 2	34	Pitch Mod
3	unnamed bank 3	35	Filters
4	unnamed bank 4	37	Output
5	unnamed bank 5	40	LFO
6	unnamed bank 6	42	Env1
7	unnamed bank 7	45	Env2
8	unnamed bank 8	48	Env3
9	unnamed bank 9	51	Effects (Programming)
10	Cart	60	Select Voice
11	Sounds	61	Copy
12	Presets	62	Write
13	Storage	63	Compare
14	up arrow, INC	64	Volume
15	down arrow, DEC	65	Pan
16	soft key 0, top left	66	Timbre
17	soft key 1, top middle	67	Key Zone
18	soft key 2, top right	68	Transpose
19	soft key 3, bottom left	69	Release
20	soft key 4, bottom middle	70	Patch Select
21	soft key 5, bottom right	73	MIDI (Performance)
22	Master	76	Effects (Performance)
25	MIDI Control	80	Multi A
27	Program Control	81	Multi B
28	Mod Mixer	83	Replace Program

VFX<sup>SD</sup> – sequencer specific button numbers:

Logical Number	Front Panel Button Name	Logical Number	Front Panel Button Name
54	Seq Control	85	Edit Seq
57	Click	86	Edit Track
58	Locate	89	Record
82	Sequence Bank Select	90	Play
84	Edit Song	92	Stop

### 3.1.2 Parameter Change (Command Type = 01)

Single parameters can be edited by EXT using this command. Since this is a short message relative to the much longer bulk dump length of a complete program, program editors running on EXT can change single parameters by using this command faster than by sending a complete program dump when only one or a few parameters change.

Absolute parameter values depend on the parameter page and slot numbers which uniquely define each parameter. Slot numbers are equivalent to soft button numbers. See section 5 of this appendix for the page and slot definitions. Most parameter values are in the low byte of the absolute value word; key range parameter types use the whole word.

00000001	01	Command Type
00000nnn	0x	Voice Number, [0..5]
000nnnnn	0x	Parameter Page Number, [0..31]
00000nnn	0x	Parameter Slot Number, [0..5]
HHHLLLLL	HL	Absolute Value Hi Byte, [0..255]
hhhlllll	hl	Absolute Value Lo Byte, [0..255]

### 3.1.3 Edit Change Status (Command Type = 02)

This command is only *transmitted* by the VFX<sup>SD</sup>; it is not received. It allows the external editor to retain synchronization with the compare buffer in the VFX<sup>SD</sup>. The edit change status command is sent whenever an edit operation initiated from the front panel of the VFX<sup>SD</sup> causes more than one parameter to change. The edit change status command will always be preceded by at least one parameter change message. Although the VFX<sup>SD</sup> will send parameter change messages, it may not be able to send the new value of every parameter that changed, due to the complexities of internal editing. When EXT receives this message, it should request a complete program dump to re-establish editing sync. The command type is the only byte in this command.

### 3.1.4 ESP Microcode Program Load (Command Type = 03)

The ESP is the audio effects processor of the VFX<sup>SD</sup>. ESP microcode can be downloaded using this command which can facilitate creating new effect programs. This command is currently not implemented, and is reserved for future use.

### 3.1.5 Poke Byte to RAM or Cartridge (Command Type = 04)

This command is not implemented on the VFX<sup>SD</sup>. It is used by the VFX only for making demo cartridges.

*Note: The VFX<sup>SD</sup> does not transmit the following Dump Request commands (command types 05 to 0A). The command type is the only byte in these commands.*

**3.1.6 Single Program Dump Request (Command Type = 05)**

The VFX<sup>SD</sup> will dump the current program using the bulk dump message described in section 3.3.1 when it receives this command. If the current program is being edited, the edited version of the program will be transmitted.

**3.1.7 Single Preset Dump Request (Command Type = 06)**

The VFX<sup>SD</sup> will dump the current preset using the bulk dump message described in section 3.3.3 when it receives this command. If the current preset is being edited, the edited version of the preset will be transmitted.

**3.1.8 Track Parameter Dump Request (Command Type = 07)**

The VFX<sup>SD</sup> will dump the track parameters using the bulk dump message described in section 3.3.7 when it receives this command.

**3.1.9 Dump Everything Request (Command Type = 08)**

The VFX<sup>SD</sup> will dump the internal RAM program banks, the internal RAM preset banks, and the track parameters using the bulk dump messages described in section 3.3 when it receives this command. Each dump is a separate message, i.e. the messages are not combined into one.

**3.1.10 Internal Program Bank Dump Request (Command Type = 09)**

The VFX<sup>SD</sup> will dump the internal RAM program banks using the bulk dump message described in section 3.3.2 when it receives this command.

**3.1.11 Internal Preset Bank Dump Request (Command Type = 0A)**

The VFX<sup>SD</sup> will dump the internal RAM preset banks using the bulk dump message described in section 3.3.4 when it receives this command.

**Sequence Dump Protocol:** Since the receiver of a sequence dump message must be prepared to store the sequence data, sequence dumps are performed using two messages from the transmitter and a handshaking message from the receiver. The transmitter sends the dump command which informs the receiver of the next message. The receiver should respond with an error message containing an ACK or NAK error code (see section 3.2.1). If the receiver does not respond within one second, the transmitter will send the dump message anyway. This timeout feature allows "dumb" System Exclusive recorders to store VFX<sup>SD</sup> sequence data. If the receiver responds with a NAK error code, the transmitter should not send the dump message.

*Note:* If the VFX<sup>SD</sup> sequencer software is not loaded, the receiving VFX<sup>SD</sup> will respond with a NAK error message to any sequence dump command.

### 3.1.12 Single Sequence Dump (Command Type = 0B)

This message is the first message of a sequence dump. The message contains the size of the sequence data which will follow in the single sequence dump message.

00001011	0B	Command Type
HHHHHHHH	HH	Sequence Data Size in bytes Hi Byte Hi Word
hhhhhhhh	hh	Sequence Data Size in bytes Lo Byte Hi Word
LLLLLLLL	LL	Sequence Data Size in bytes Hi Byte Lo Word
llllllll	ll	Sequence Data Size in bytes Lo Byte Lo Word

*Note:* A Track Parameter bulk dump message will be transmitted after the completion of the single sequence dump. This will allow a receiving VFX to be configured for sound expansion, i.e. any sequence track in the VFX<sup>SD</sup> can have a MIDI status which will allow the receiving VFX to respond properly.

### 3.1.13 All Sequence Memory Dump (Command Type = 0C)

This message is the first message of a complete sequence memory dump. The message contains the size of the sequence data which will follow in the all sequence dump message.

00001100	0C	Command Type
HHHHHHHH	HH	Sequence Data Size in bytes Hi Byte Hi Word
hhhhhhhh	hh	Sequence Data Size in bytes Lo Byte Hi Word
LLLLLLLL	LL	Sequence Data Size in bytes Hi Byte Lo Word
llllllll	ll	Sequence Data Size in bytes Lo Byte Lo Word

### 3.1.14 Single Sequence Dump Request (Command Type = 0D)

The VFX<sup>SD</sup> will dump the currently selected sequence using the bulk dump message described in section 3.1.12 when it receives this command. The command type is the only byte in this command.

### 3.1.15 All Sequence Dump Request (Command Type = 0E)

The VFX<sup>SD</sup> will dump all sequence memory using the bulk dump message described in section 3.1.13 when it receives this command. The command type is the only byte in this command.

### 3.2 Error Messages (Message Type = 01)

Error messages are transmitted by the VFX<sup>SD</sup> when an error occurs while processing any of the command messages described in section 3.1. The VFX<sup>SD</sup> ignores error messages unless a sequence dump is being processed.

#### 3.2.1 Command Message Error Codes

These codes are the data byte of error messages.

Code	Name	Meaning
00	NAK	The preceding command message could not be processed. The receiver is busy or the message is unintelligible. The preceding dump command is not acceptable.
01	INVALID PARAMETER NUMBER	The parameter voice, page, or slot in the preceding parameter value message doesn't make sense.
02	INVALID PARAMETER VALUE	The parameter value in the preceding parameter value message is out of range.
03	INVALID BUTTON NUMBER	The button number in the preceding virtual button message doesn't correspond to any real button number.
04	ACK	The preceding dump command is acceptable.

### 3.3 Bulk Dumps of Programs, Presets, Track Parameters, and Sequences

Bulk dump data messages are transmitted using the message format described in section 2.3. The message type byte, which is part of the system exclusive header, is given in hexadecimal with the name of the dump message. The actual data bytes for programs, presets, and sequences are described in section 4. The MIDI data byte lengths are listed in decimal for each message type.

#### 3.3.1 One Program (Message Type = 02)

MIDI Data byte length = 1060 + head and tail = 1067

The current selected program is transmitted. If the compare buffer is active (the Compare LED is on), then the program in the compare buffer will be transmitted. If this message is received, the new program will be put in the compare buffer so it can be written to internal or cartridge memory. Remember that the compare buffer is over-written by the incoming data and its previous contents are lost.

#### 3.3.2 All Programs (Message Type = 03)

MIDI Data byte length = 1060\*60 = 63600 + head and tail = 63607

All 60 programs in the 10 internal RAM program banks are contained in this message.

**3.3.3 One Preset (Message Type = 04)**

MIDI Data byte length = 96 + head and tail = 103

The current selected preset is transmitted. If this message is received, the new preset will be put in the preset buffer so it can be written to any preset location. If presets are being edited (the preset LED on, but no preset number LEDs are on), then the received preset will become the current preset.

**3.3.4 All Presets (Message Type = 05)**

MIDI Data byte length = 96\*20 = 1920 + head and tail = 1927

All 20 presets in the 2 internal RAM preset banks are contained in this message.

**3.3.5 Single Sequence Dump (Message Type = 09)**

MIDI Data byte length = variable depending on amount of sequence data

This message is transmitted according to the sequence dump protocol described before section 3.1.12. It contains sequence data and track parameters.

**3.3.6 All Sequence Dump (Message Type = 0A)**

MIDI Data byte length = variable depending on amount of sequence data

This message is transmitted according to the sequence dump protocol described before section 3.1.12. It contains global sequence parameters, sequence data, and sequence track parameters.

**3.3.7 Track Parameters (Message Type = 0B)**

MIDI Data byte length = 22\*12 = 264 + 12 + 11 + head and tail = 294

All track parameter data for the 12 tracks, the track status array, and the tracks effect parameters are transmitted.

## 4 Parameter Block Data Descriptions

This is a description of the parameter blocks transmitted using the bulk dump messages described in section 3.3. The names and byte offsets of each block parameter are given. The parameter value ranges are included in section 5. The following byte layout is the internal representation and not the MIDI byte format which is described in section 2.3.

### 4.1 Program Parameters

The first group of parameters through byte offset 82 describe one of the six possible voices in a program. All of the global program parameters are at the bottom of this list. When the program has a custom pitch table installed, voices 5 and 6 are replaced with the pitch table data. In this case, starting at the beginning of voice 5, there is a packed list of fourteen bit records consisting of a 7 bit MIDI key number and 7 bits of pitch fine tune. There are 88 records for the complete keyrange A0 - C8.

Byte Offset	Parameter Name
0	Env1 Initial Level
1	Env1 Attack Time
2	Env1 Peak Level
3	Env1 Decay Time 1
4	Env1 Breakpoint 1
5	Env1 Decay Time 2
6	Env1 Breakpoint 2
7	Env1 Decay Time 3
8	Env1 Sustain Level
9	Env1 Release Time
10	Env1 Level Velocity Sensitivity
11	Env1 Attack Time Velocity Sensitivity
12	Env1 Keyboard Tracking
13	Env1 Mode (hi nybble) and Velocity Curve (lo nybble)
14	Env2 Initial Level
15	Env2 Attack Time
16	Env2 Peak Level
17	Env2 Decay Time 1
18	Env2 Breakpoint 1
19	Env2 Decay Time 2
20	Env2 Breakpoint 2
21	Env2 Decay Time 3
22	Env2 Sustain Level
23	Env2 Release Time
24	Env2 Level Velocity Sensitivity
25	Env2 Attack Time Velocity Sensitivity
26	Env2 Keyboard Tracking
27	Env2 Mode (hi nybble) and Velocity Curve (lo nybble)
28	Env3 Initial Level
29	Env3 Attack Time
30	Env3 Peak Level
31	Env3 Decay Time 1
32	Env3 Breakpoint 1
33	Env3 Decay Time 2
34	Env3 Breakpoint 2
35	Env3 Decay Time 3
36	Env3 Sustain Level
37	Env3 Release Time

Byte Offset	Parameter Name
38	Env3 Level Velocity Sensitivity
39	Env3 Attack Time Velocity Sensitivity
40	Env3 Keyboard Tracking
41	Env3 Mode (hi nybble) and Velocity Curve (lo nybble)
42	Pitch Root Key
43	Pitch Fine Tune
44	Pitch Table
45	Pitch Env1 Modulation Amount
46	Pitch LFO Modulation Amount
47	Pitch Glide (hi nybble) and Pitch Modulation Source (lo nybble)
48	Pitch Modulation Amount
49	Filter #1 Cutoff
50	Filter #1 Keyboard Modulation Amount
51	Filter #1 Env2 Modulation Amount
52	Filter Mode (hi nybble) and Filter #1 Modulation Source
53	Filter #1 Modulation Amount
54	Filter #2 Cutoff
55	Filter #2 Keyboard Modulation Amount
56	Filter #2 Env2 Modulation Amount
57	Filter #2 Modulation Source
58	Filter #2 Modulation Amount
59	Volume Fade Shape
60	Volume Fade Key Zone Low
61	Volume Fade Key Zone High
62	Volume and Pre-Gain Switch (MSB)
63	Pan Mod Source (hi nybble) and Volume Mod Source (lo nybble)
64	Volume Modulation Amount
65	Pan
66	Pan Modulation Amount
67	Voice Priority (hi nybble) and Output Routing (lo nybble)
68	LFO Waveshape (hi nybble) and LFO Mod Source (lo nybble)
69	LFO Depth
70	LFO Restart Mode (hi nybble) and LFO Speed Mod Source (lo nybble)
71	LFO Speed Modulation Amount
72	LFO Speed
73	LFO Delay Time
74	Waveform
75	Wave Class (hi nybble) and Wave Mod Source (lo nybble)
76	Wave Mod Amount
77	Wave Start Index
78	Noise Source Rate
79	Wave Delay Time
80	Mixer Curve (hi nybble) and Mixer Mod Source #1 (lo nybble)
81	Mixer Scaler (hi nybble) and Mixer Mod Source #2 (lo nybble)
82	Velocity Threshold

(end of Voice #1 structure)



Byte Offset	Parameter Name
83	Voice #2 (same structure as Voice #1)
166	Voice #3 (same structure as Voice #1)
249	Voice #4 (same structure as Voice #1)
332	Voice #5 (same as Voice #1 or program pitch table data, if enabled)
415	Voice #6 (same as Voice #1 or program pitch table data, if enabled)
498	Program Name - (11 bytes or characters)
509	Program Patch #1 (lo 6 bits)
	Program Pressure (Performance parameter) - (hi 2 bits)
510	Program Patch #2 (lo 6 bits)
511	Program Patch #3 (lo 6 bits)
512	Program Patch #4 (lo 6 bits)
513	<i>reserved</i> (hi nybble) and Pitch Table Switch (lo nybble)
514	Program Glide Time
515	Program Delay Factor (hi nybble) and Global Bend Range (lo nybble)
516	Program Restrike
517	Program Timbre (Performance parameter)
518	Program Release (Performance parameter)
519	Program Effect Parameters 1 to 8
527	Program Effect FX1 Mix
528	Program Effect FX2 Mix
529	Program Effect Select

## 4.2 Preset Parameters

### 4.2.1 Track Parameter Structure

The parameters from each of the three individual tracks of a Preset are stored as an array of variable size bit fields packed into 11 consecutive bytes.

*Note: the internal packing scheme actually inverts each of the individual bytes. When they are received, they will appear to be inverted (mirror images) of the bit masks as described below. They must be transmitted in the inverted state.*

Byte Offset	Bit Mask	Parameter Name
0	VVVVVVVC	Volume (7 bits) and first bit of MIDI Channel
1	CCCSSTTT	MIDI Channel (lo 3 bits), Status (2 bits), and Timbre controller value (hi 3 bits)
2	TTTTXXXX	Timbre controller value (lo 4 bits) and X(transpose) (hi 4 bits)
3	XXXXLLLL	X(transpose) (lo 4 bits) and Low key (hi 4 bits)
4	LLLHHHHH	Low key (lo 3 bits) and High key (hi 5 bits)
5	HHSSPPP	High key (lo 2 bits), patch Select (3 bits), and MIDI Program number (hi 3 bits)
6	PPPPRLL	MIDI Program number (lo 4 bits), pPressure type (2 bits), and reLease time (hi 2 bits)
7	LLLLLLPP	reLease time (lo 6 bits) and Pan (hi 2 bits)
8	PPPPPEE	Pan (lo 6 bits) and Effect routing (hi 2 bits)
9	ESxxxxxx	Effect routing (lo bit) and Sustain pedal on/off (1 bit)
		x = spare bits reserved for future use
10	iiiiiii	i internal program number

### 4.2.2 Preset Effect Parameter Structure

The parameters from the preset effect are stored as an array of variable size bit fields packed into 11 consecutive bytes. The effect select and mix values are packed into 7 bits each, and the parameters are packed as 8 bit numbers.

*Note: the internal packing scheme actually inverts each of the individual bytes. When they are received, they will appear to be inverted (mirror images) of the bit masks as described below. They must be transmitted in the inverted state.*

Byte Offset	Bit Mask	Parameter Name
0	EEEEEEEM	Effect select (7 bits) and hi bit of FX1 Mix
1	MMMMMMmm	FX1 Mix (lo 6 bits) and hi 2 bits of FX2 mix
2	mmmmm111	FX2 mix (lo 5 bits) and param 1 (hi 3 bits)
3	11111222	param 1 (lo 5 bits) and param 2 (hi 3 bits)
4	22222333	param 2 (lo 5 bits) and param 3 (hi 3 bits)
5	33333444	param 3 (lo 5 bits) and param 4 (hi 3 bits)
6	44444555	param 4 (lo 5 bits) and param 5 (hi 3 bits)
7	55555666	param 5 (lo 5 bits) and param 6 (hi 3 bits)
8	66666777	param 6 (lo 5 bits) and param 7 (hi 3 bits)
9	77777888	param 7 (lo 5 bits) and param 8 (hi 3 bits)
10	88888xxx	param 8 (lo 5 bits) and 3 spare bits (x)

### 4.2.3 Preset Dump Structure

A complete preset dump is composed of three sets of packed track parameters (33 bytes), followed by a 3 bytes track status array containing information about layering, an effect definition (11 bytes), and a spare byte for a total of 48 bytes.

Byte Offset	Parameter Name
0	Preset Track 0 parameters
11	Preset Track 1 parameters
22	Preset Track 2 parameters
33	Preset Track status array
36	Preset Effect parameters
47	spare (reserved for future use)

### 4.3 Track Parameters

This message consists of specific track parameters from the 12 tracks, the track status array, and an effect definition.

Byte Offset	Parameter Name
0	Track 1 Program number and pointer ( 4 bytes = NPPP ) N= First byte = Program number 0..179 P = Next 3 bytes = 24 bit pointer to program data. This pointer will be recalculated based on the program number when the dump is received by the VFX <sup>SD</sup> .
4	Track 1 Timbre
6	Track 1 Release
8	Track 1 Mix
10	Track 1 Effect Routing Override
12	Track 1 Patch Select override
13	Track 1 Sustain Enable switch
14	Track 1 MIDI Channel
15	Track 1 MIDI Program number
16	Track 1 MIDI Pressure type (off,mono,poly)
17	Track 1 MIDI Status (local,midi,both)
18	Track 1 Key Zone low key
19	Track 1 Transpose
20	Track 1 Key Zone high key
21	Track 1 Pan

(end of Track 1 structure)

22	Track 2 parameters (same structure as Track 1)
44	Track 3 parameters (same structure as Track 1)
66	Track 4 parameters (same structure as Track 1)
88	Track 5 parameters (same structure as Track 1)
110	Track 6 parameters (same structure as Track 1)
132	Track 7 parameters (same structure as Track 1)
154	Track 8 parameters (same structure as Track 1)
176	Track 9 parameters (same structure as Track 1)
198	Track 10 parameters (same structure as Track 1)
220	Track 11 parameters (same structure as Track 1)
242	Track 12 parameters (same structure as Track 1)
264	Multi Track status array
276	Tracks Effect Parameters 1 to 8
284	Tracks Effect FX1 Mix
285	Tracks Effect FX2 Mix
286	Tracks Effect Select

*Note: The sequencer data format is not currently documented, so these blocks are only described in general terms.*

#### 4.4 Single Sequence Dump Parameters

This message consists of the data from one sequence and the sequence header.

Byte Offset	Parameter Name
0	Sequence Data
n	Sequence Header

#### 4.5 All Sequence Dump Parameters

This message consists of the data from one sequence, the sequence header, and the global sequencer parameters.

Byte Offset	Parameter Name
0	Sequence Data Pointer Offsets - each offset is a long word from the beginning of the parameter block. There are 60 offsets, one for each sequence/song.
239	Sequence Data
n	Sequence Header
n+header_size	Global Parameters

## 5 Parameter Page and Slot Definitions

This is a table of all parameter page and slot (or soft button) numbers for voice and system parameters including the parameter value ranges. Note that in cases where more than one slot number is assigned to a parameter that the *highest* number should be used in all Parameter Change messages (section 3.1.2). Messages containing the alternate slot numbers will be ignored.

Page	Slot	Range	Parameter Name and Description
<b>Master pages</b>			
0	0	-128..+127	Master Tune
0	1	0..15	Touch: - SOFT,MED,FIRM,HARD 1-4
0	2	0..12	System Bend Range
0	3		undefined
0	4	0..4	FS1 Auxiliary Footswitch Configuration: - UNUSED,SOSTENU,PATCH L,ADVANCE
0	5	0,1	FS2 Footswitch Configuration: - SUSTAIN,PATCH R
1	0		undefined
1	1	0,1	Slider mode: - NORMAL,TIMBRE
1	2	0,1	CV Pedal Configuration: - VOL,MOD
1	3,4		undefined
1	5	0,1	System Pitch Table: - CUSTOM,NORMAL
2	0	0..127	Maximum Keyboard Velocity
2	1,2	0,1	MIDI track naming: - OFF,ON
2	3,4		Voice Muting: - OFF,ON
2	5	0,1	Keyboard naming: - OFF,ON
<b>MIDI Control pages</b>			
3	0	0..15	MIDI Base Channel
3	1		undefined
3	2	0,1	MIDI Send Channel: - BASE,TRACK
3	3	0..4	MIDI Mode: - OMNI,POLY,MULTI,MONO A,MONO B
3	4	0..2	MIDI Transpose: - SEND,RCV,BOTH
3	5	0..95	MIDI External Controller number
4	0	0,1	MIDI Loop Switch: - OFF,ON
4	1	0,1	MIDI Controllers enable flag: - OFF,ON
4	2	0,1	MIDI Song Select enable flag: - OFF,ON
4	3	0,1	MIDI Send Start/Stop flag: - OFF,ON
4	4	0,1	MIDI System Exclusive enable flag: - OFF,ON
4	5	0..2	MIDI Program Change enable flag: - OFF,ON,NEW
<b>Program Control page</b>			
5	0,1	0,1	Pitch Table enable flag: - OFF,ON
5	2	0..13	Program Bend Range (13=global)
5	3	0..3	Delay Multiplier: - X1,X2,X4,X8
5	4	0..99	Program Restrike Delay Time
5	5	0..99	Program Glide Time
<b>Mod Mixer page</b>			
6	0		undefined
6	1	0..15	Mod Mixer Mod Source #1
6	2	0..15	Mod Mixer Mod Source #2
6	3,4	0..15	Mod Mixer Scaler
6	5	0..15	Mod Mixer Shape

Page	Slot	Range	Parameter Name and Description
Select Voice (voice status) page			
38	0-5	0..2	Voice Status: - OFF,ON,SOLO
Wave Page — pages 7-10 are used for all wave types or classes but there are different interpretations of parameters depending on the current wave class. When changing wave page parameters, be sure the wave class is set first, otherwise parameter values may be invalid. When the wave class is changed, the other wave parameters are reset to default values. <i>Note - these are always output as page 7, but should be input as pages 7..10, depending on wave class.</i>			
7..10	0	0..140	Wave Name (0..147 for VFX <sup>SD</sup> Version II)
7..10	1	0..11	Wave Class (0..12 for VFX <sup>SD</sup> Version II)
7..10	2	0..251	Delay Time (251=key up)
The following slots are for the sampled wave classes (strings, brass, bass, breath, tuned percussion, and percussion).			
7	3	0..127	Wave Start Index
7	4	-127..127	Wave Velocity Start Mod
7	5	0,1	Wave Direction: - FORWARD,REVERSE
The following slots are specifically for TRANSWAVE class (6)			
8	4	0..15	Wave Mod Source
8	5	-127..+127	Wave Mod Amount
The following slots are specifically for the WAVEFORM and INHARMONIC classes (7 and 8, respectively)			
9	3-5		undefined
The following slots are specifically for the looping MULTI-WAVE class (9)			
10	3	0..249	Loop Wave Start number
10	4	1..243	Loop Length
10	5	0,1	Loop Direction: - FORWARD,REVERSE
Pitch page			
11	0	-4..+4	Pitch Octave
11	1	-12..+12	Pitch Semitone
11	2	-127..127	Pitch Fine Tune
11	3,4	0..2	Pitch Table type: - SYSTEM,ALL-C4,CUSTOM
11	5		undefined
Pitch Mod page			
12	0		undefined
12	1	0..15	Pitch Mod Source
12	2	-99..+99	Pitch Mod Amount
12	3	0..4	Glide Mode: - NONE,PEDAL,MONO,LEGATO,TRIGGER
12	4	-127..+127	Pitch Env1 Mod Amount
12	5	-127..+127	Pitch LFO Mod Amount

Page	Slot	Range	Parameter Name and Description
Filter pages			
13	0	0,1	Filter #1 Type: - LO-PASS/2,LO-PASS/3
13	1	0..127	Filter #1 Cutoff
13	2	-127..+127	Filter #1 Keyboard Tracking Amount
13	3	0..15	Filter #1 Mod Source
13	4	-127..+127	Filter #1 Mod Amount
13	5	-127..+127	Filter #1 Env2 Mod Amount
14	0	0..3	Filter #2 Type: - HI-PASS/2,HI-PASS/1,LO-PASS/2,LO-PASS/1
14	1	0..127	Filter #2 Cutoff
14	2	-127..+127	Filter #2 Keyboard Tracking Amount
14	3	0..15	Filter #2 Mod Source
14	4	-127..+127	Filter #2 Mod Amount
14	5	-127..+127	Filter #2 Env2 Mod Amount
Output pages			
15	0	0..127	Volume
15	1	0..15	Volume Mod Source
15	2	-127..+127	Volume Mod Amount
15	3	-128..+127	Keyboard Scaling amount (-128=ZONE)
15	4,5	21..108	Scaling Key Range (low and high keys)
16	0		undefined
16	1,2	0..3	Output Destination: - DRY,FX1,FX2,AUX
16	3	0..127	Pan
16	4	0..15	Pan Mod Source
16	5	-127..+127	Pan Mod Amount
17	0	0,1	Voice Pre-Gain Switch: - OFF,ON
17	1,2	0..2	Voice Priority: - LO,MED,HI
17	3		undefined
17	4,5	-127..+127	Voice Velocity Threshold
LFO pages			
18	0	0..99	LFO Rate
18	1	0..15	LFO Rate Mod Source
18	2	-127..+127	LFO Rate Mod Amount
18	3	0..127	LFO Depth
18	4	0..15	LFO Depth Mod Source
18	5	0..99	LFO Delay
19	0,1	0..6	LFO Waveshape: - TRIANGLE,SINE,SINE/TRI, POS/SIN,SAWTOOTH,SQUARE
19	2	0,1	LFO Restart Switch: - OFF,ON
19	3,4,5	0..127	Noise Source Rate

Page	Slot	Range	Parameter Name and Description
Envelope pages			
20	0		undefined
20	1	0..127	Env1 Initial Level
20	2	0..127	Env1 Peak Level
20	3	0..127	Env1 Breakpoint 1 Level
20	4	0..127	Env1 Breakpoint 2 Level
20	5	0..127	Env1 Sustain Level
21	0		undefined
21	1	0..99	Env1 Attack Time
21	2	0..99	Env1 Decay 1 Time
21	3	0..99	Env1 Decay 2 Time
21	4	0..99	Env1 Decay 3 Time
21	5	-100..+99	Env1 Release Time
22	0	-127..+127	Env1 Keyboard Tracking
22	1,2	0..9	Env1 Velocity Curve
22	3	0..2	Env1 Mode: - NORMAL,FINISH,REPEAT
22	4	0..127	Env1 Level Velocity Sensitivity
22	5	0..127	Env1 Attack Time Velocity Sensitivity
23	0		undefined
23	1	0..127	Env2 Initial Level
23	2	0..127	Env2 Peak Level
23	3	0..127	Env2 Breakpoint 1 Level
23	4	0..127	Env2 Breakpoint 2 Level
23	5	0..127	Env2 Sustain Level
24	0		undefined
24	1	0..99	Env2 Attack Time
24	2	0..99	Env2 Decay 1 Time
24	3	0..99	Env2 Decay 2 Time
24	4	0..99	Env2 Decay 3 Time
24	5	-100..+99	Env2 Release Time
25	0	-127..+127	Env2 Keyboard Tracking
25	1,2	0..9	Env2 Velocity Curve
25	3	0..2	Env2 Mode: - NORMAL,FINISH,REPEAT
25	4	0..127	Env2 Level Velocity Sensitivity
25	5	0..127	Env2 Attack Time Velocity Sensitivity
26	0		undefined
26	1	0..127	Env3 Initial Level
26	2	0..127	Env3 Peak Level
26	3	0..127	Env3 Breakpoint 1 Level
26	4	0..127	Env3 Breakpoint 2 Level
26	5	0..127	Env3 Sustain Level
27	0		undefined
27	1	0..99	Env3 Attack Time
27	2	0..99	Env3 Decay 1 Time
27	3	0..99	Env3 Decay 2 Time
27	4	0..99	Env3 Decay 3 Time
27	5	-100..+99	Env3 Release Time
28	0	-127..+127	Env3 Keyboard Tracking
28	1,2	0..9	Env3 Velocity Curve
28	3	0..2	Env3 Mode: - NORMAL,FINISH,REPEAT
28	4	0..127	Env3 Level Velocity Sensitivity
28	5	0..127	Env3 Attack Time Velocity Sensitivity



The effect parameter pages are dependent on the currently selected effect. When changing effect page parameters, be sure the effect type is selected first, otherwise parameter values may be invalid. When the effect type is changed, the other effect parameters assume preset values. The first four slots [0..3] of page 29 are common to all effects and exceptions are noted in the rotary speaker simulators. The following table interprets the values of Effect Type (page 29, slot 0,1). The Parameter Set Name corresponds to the parameter descriptions on the following pages.

Effect Type	Preset Name	Parameter Set Name
0	LARGE.HALL.REVRB	Hall Reverb
1	ROOM.REVERB.1	Hall Reverb
2	DYNAMIC.REVERB	Dynamic Reverb
3	8-VOICE.CHORUS.1	Multi-Voice Chorus
4	CHORUS+REVERB.1	Chorus and Reverb
5	FLANGER+REVERB.1	Flanger and Reverb
6	SMALL.HALL.REVRB	Hall Reverb
7	ROOM.REVERB.2	Hall Reverb
8	CHORUS+REVERB.2	Chorus and Reverb
9	FLANGER+REVERB.2	Flanger and Reverb
10	DELAY+REVERB.1	Delay and Reverb
11	DELAY+REVERB.2	Delay and Reverb
12	FLANGE+DLY+REV.1	Flanger, Delay, and Reverb
13	FLANGE+DLY+REV.2	Flanger, Delay, and Reverb
14	ROTO-SPKR+DELAY	Rotary Speaker Simulator
15	CONCERT REVERB	Hall and Room Reverb
16	WARM CHAMBER	Hall and Room Reverb
17	GATED+ROOM.VERBS	Gated and Room Reverb
18	DIRTY-ROTO+DELAY	Rotary Speaker Simulator with Distortion
19	DYNAMIC.HALL	Dynamic Reverb
20	8-VOICE.CHORUS.2	Multi-Voice Chorus
21	DLY+FLANGE+HALL	Flanger, Delay, and Reverb

### Hall Reverb

Page	Slot	Range	Parameter Name and Description
29	0,1	0..15	Effect Type
29	2	0..99	Decay Time
29	3		undefined
29	4	0..127	Reverb (FX1) Mix
29	5	0..127	Reverb (FX2) Mix
30	0,1		undefined
30	2	0..250	Pre-delay Time
30	3		undefined
30	4,5	0..127	Early Reflection
31	0		undefined
31	1,2	0,1	FX2 Mode: - NORMAL.STEREO.SEND,LEFT.WET/RIGHT.DRY
31	3		undefined
31	4,5	0..99	High Frequency Damping

**Dynamic Reverb**

Page	Slot	Range	Parameter Name and Description
29	4	0..127	Reverb (FX1) Mix
29	5	0..127	Reverb (FX2) Mix
30	0,1	-128..127	Decay Modulation Amount
30	2	0..250	Pre-delay Time
30	3	0..11	Decay Modulation Source
30	4,5	0..127	Early Reflection
31	0		undefined
31	1,2	0,1	FX2 Mode: - NORMAL.STEREO.SEND,LEFT.WET/RIGHT.DRY
31	3		undefined
31	4,5	0..99	High Frequency Damping

**Multi-Voice Chorus**

Page	Slot	Range	Parameter Name and Description
29	4	0..127	Chorus (FX1) Mix
29	5	0..127	Chorus (FX2) Mix
30	0	0..99	Chorus Rate
30	1	0..127	Chorus Depth
30	2	0..100	Chorus Delay Time
30	3	-128..127	Chorus Feedback
30	4,5		undefined
31	0		undefined
31	1,2	0,1	FX2 Mode: - NORMAL.STEREO.SEND,LEFT.WET/RIGHT.DRY
31	3-5		undefined

**Chorus and Reverb**

Page	Slot	Range	Parameter Name and Description
29	4	0..127	Chorus (FX1) to Reverb Mix
29	5	0..127	Reverb (FX2) Mix
30	0	0..99	Chorus Rate
30	1	0..127	Chorus Depth
30	2	0..250	Chorus Delay Time
30	3	-128..127	Chorus Rate Modulation Amount
30	4	-128..127	Chorus Depth Modulation Amount
30	5	0..127	Chorus Mix
31	0,1	0,1	LFO Waveshape
31	2	0..11	Chorus Mod Source
31	3		undefined
31	4,5	0,1	Reverb High Frequency Cut Switch: - OFF,ON

VFX<sup>SD</sup> version 2.00 added a new variation of the Chorus and Reverb effect, which includes a distortion parameter and eliminates the LFO Waveshape parameter.

**Chorus and Reverb with Distortion**

31	0,1		undefined
31	3	0..15	Overdrive Output Level (16 values from 00..99)

**Flanger and Reverb**

Page	Slot	Range	Parameter Name and Description
29	4	0..127	Flanger (FX1) to Reverb Mix
29	5	0..127	Reverb (FX2) Mix
30	0	0..99	Flanger Rate
30	1	0..127	Flanger Minimum
30	2	0..127	Flanger Maximum
30	3	0..11	Flanger Rate Modulation Source
30	4	-128..127	Flanger Minimum Modulation Amount
30	5	-128..127	Flanger Maximum Modulation Amount
31	0	0..15	Flanger Mix Level
31	1		undefined
31	2	-128..127	Flanger Feedback
31	3		undefined
31	4,5	0,1	Reverb High Frequency Cut Switch: - OFF,ON

**Delay and Reverb**

Page	Slot	Range	Parameter Name and Description
29	4	0..127	Delay (FX1) to Reverb Mix
29	5	0..127	Reverb (FX2) Mix
30	0	0..250	Delay Time
30	1	-128..127	Delay Regeneration
30	2		undefined
30	3	-128..127	Delay Time Modulation Amount
30	4	-128..127	Delay Regeneration Modulation Amount
30	5	0..127	Delay Mix
31	0,1		undefined
31	2	0..11	Delay Modulation Source
31	3		undefined
31	4,5	0,1	Reverb High Frequency Cur Switch: - OFF,ON

**Flanger, Delay, and Reverb**

Page	Slot	Range	Parameter Name and Description
29	4	0..127	Flanger and Delay (FX1) to Reverb Mix
29	5	0..127	Reverb (FX2) Mix
30	0	0..99	Flanger Rate
30	1	0..127	Flanger Minimum
30	2	0..127	Flanger Maximum
30	3	-128..127	Flanger Feedback
30	4,5		undefined
31	0	0..200	Delay Time
31	1	-128..127	Delay Regeneration
31	2	0..127	Delay Mix
31	3		undefined
31	4,5	0,1	Reverb High Frequency Cut Switch: - OFF,ON

**Rotary Speaker Simulator**

Page	Slot	Range	Parameter Name and Description
29	2	0..250	Delay Time
29	4	0..127	Rotating Speaker (FX1) to Delay Mix
29	5	0..127	Delay (FX2) Mix
30	0	0..99	Rotor Speed Low
30	1	0..99	Rotor Speed High
30	2	0,1	Lo-Rotor Switch: - OFF,ON
30	3,4	0..11	Rotor Speed Modulation Source
30	5	0..2	Motor Mode: - CONTIN,SWITCH,TOGGLE
31	0	0..100	Feedback Lag
31	1		undefined
31	2	-128..127	Delay Repeats
31	3	-128..127	Feedback Lag Amount
31	4,5	0..127	Stereo Width

**Hall and Room Reverb**

29	4	0..127	Reverb (FX1) Mix
29	5	0..127	Reverb (FX2) Mix
30	0		undefined
30	1	0..127	Diffusion
30	2	0..250	Pre-delay Time
30	3,4	0..127	Early Reflection Level
30	5	0..200	Early Reflection Time
31	0		undefined
31	1,2	0,1	FX2 Mode:- NORMAL,STEREO.SEND,LEFT.WET/RIGHT.DRY
31	3	-128..+127	Low Frequency Decay
31	4,5	0..99	High Frequency Damping

**Gated and Room Reverb**

29	4	0..127	Reverb (FX1) Mix
29	5	0..127	Reverb (FX2) Mix
30	0	0..200	Gate Time
30	1	0..100	Slope
30	2	0..127	Threshold
30	3,4	0..200	Pre-delay Time
30	5	0..200	Release Time
31	0		undefined
31	1,2	0..250	Pre-delay Time
31	3		undefined
31	4,5	0..99	High Frequency Damping

**Rotary Speaker Simulator with Distortion**

29	2	0..250	Delay Time
29	4	0..127	Rotating Speaker (FX1) to Delay Mix
29	5	0..127	Delay (FX2) Mix
30	0	0..99	Rotor Speed Low
30	1	0..99	Rotor Speed High
30	2	0..15	Overdrive
30	3,4	0..11	Rotor Speed Modulation Source
30	5	0..2	Motor Mode: - CONTIN,SWITCH,TOGGLE
31	0	0..100	Feedback Lag
31	1		undefined
31	2	-128..127	Delay Repeats
31	3	-128..127	Feedback Lag Amount
31	4,5	0..15	Low Rotor Volume

Appendix B — VFX<sup>SD</sup> MIDI Implementation Chart

MODEL: VFX-SD

MIDI Implementation Chart

Version: 1.0

Function...	Transmitted	Recognized	Remarks
Basic Channel Default Channel	1 1- 16	1 1- 16	
Mode Default Messages Altered	1 X X	1, 3, 4, Multi X X	memorized (Global Controllers in MONO Mode)
Note Number True Voice	21 - 108	21 - 108	
Velocity Note ON Note OFF	O X*	O X	
After Touch Key's Ch's	O O	O O	
Pitch Bender	O	O	
Control Change	1 - 95 1 Mod Wheel 4 Foot 7 Volume 10 Pan 70 Momentary Patch Select 71 Timbre Parameter 72 Release Parameter 100 Registered Param Select 101 Registered Param Select	1 - 95 1 Mod Wheel 4 Foot 7 Volume 10 Pan 70 Momentary Patch Select 71 Timbre Parameter 72 Release Parameter 100 Registered Param Select 101 Registered Param Select	programmable
Prog Change True #	0 - 127	0 - 119, 124 - 127	
System Exclusive	O	O	
System Common : Song Pos : Song Sel : Tune	O O X	O O X	
System Real Time : Clock : Commands	O Clock O Start, Stop, Cont	O Clock O Start, Stop, Cont	
Aux Messages : Local On/Off : All Notes Off : Active Sense : Reset	X X X X	X X X X	
<b>Notes</b> * A Note Off velocity of 64 is always sent for all keys.			

Mode 1: OMNI ON, POLY  
Mode 3: OMNI OFF, POLY

Mode 2: OMNI ON, MONO  
Mode 4: OMNI OFF MONO

O : YES  
X : NO

- Add Bars**, 12-8
- Append**, 12-6
- Autopunch**, 5-15, 21, 25
- Auxiliary Outputs**, 1-3, 5-30, 31, 8-24
- Available Options**, 1-11
- Banks**, 2-2, 3, 5, 6
- Base Channel (MIDI)**, 6-5  
 Receive, 6-5  
 Transmit, 6-5  
*See also* MIDI Control Page
- Bend range**, 6-2, 7-7  
*See also* Master Page  
*See also* Program Control Page
- Cart**, 2-1, 2, 3
- Cartridge**, 1-9  
 Insertion/Removal, 1-9  
 Writing to/from Cartridge, 7-9, 10, 11-15
- Click**, 5-23  
 Click Page, 5-13
- Compare**, 7-3  
 Compare LED, 7-3
- Connections**, 1-1  
 AC line conditioning, 1-1  
 Amplification, 1-1, 2  
 Power, 1-1  
 Rear Panel Connections, 1-3
- Controllers**  
 MIDI, 6-5, 6, 13-2  
 Performance, 1-8, 9  
 Recording, 5-29
- Copying**, 7-10, 10-1, 11-6, 15  
 Copy buffer, 10-2, 10-6  
 Copy context, 10-1  
 Copy disk, 10-6  
 Copy functions, 10-1  
 Copying a complete Program, 10-6  
 Copying all parameters, 10-5  
 Copying an effect from a program, 10-5  
 Copying from Cartridge, 11-16, 19  
 Copying from several sources, 10-6  
 Copying the compare buffer, 10-6  
 Copying to Cartridge, 11-15, 17, 18  
 Copy Sequence, 12-7  
 Copy Song, 12-2
- Copy Track**, 12-13  
 Default, 10-4  
 Make Copy, 10-2  
 Recall, 10-3, 4  
 Special Copy operations, 10-4  
 Special Recall functions, 10-3  
 System, 10-5
- Countoff**, 5-13, 23
- Create Song or Sequence**, 5-11
- CV-Pedal**, 1-3, 11, 6-3  
 As Modulation Pedal, 6-3, 8-6  
 As Volume Pedal, 6-3  
 Input, 1-3  
*See also* Master Page
- Data Entry**, 1-7  
 Data Entry Slider, 1-6  
 Parameter Changes, 1-5  
 Parametric Programming, 1-5  
 Soft Buttons, 1-5  
 Underlining, 1-7  
 Up and Down Arrow buttons, 1-5
- Delay**, 7-7
- Delete Bars**, 12-9
- Destination bus**, 4-3, 4, 5-30, 8-24
- Disk**, 11-2  
 Capacity, 11-3  
 Copy, 11-6  
 Delete files from, 11-12  
 Error Messages, 11-25  
 File Banks, 11-4, 9, 11  
 File Types, 11-2  
 Format, 11-5  
 Functions, 11-4  
 Loading from, 11-2, 11-10  
 Saving to, 11-2, 7  
 Sys-Ex data, 11-3, 13, 14
- Double-clicking**, 2-3
- Drum Machine**, using with a, 13-1
- DRY**, 4-3, 4, 7, 5-30, 7-1, 8-24
- Dynamic Voice Assignment**, 7-2, 13-5
- Edit**  
 Edit Buffer, 7-3  
 Edit Seq Page, 12-6  
 Edit Song Page, 12-1  
 Edit Song Steps, 12-3  
 Edit Times, 5-21  
 Edit Track Page, 12-10  
 Event Edit, 12-15
- Effects**, 4-1  
 Effects Busses, 4-3  
 Loading Effects, 4-6  
 Mixing Effects, 4-4  
 Modulation Sources, 4-5  
 Multiple Function Effect, 4-4  
 Performance Control, 4-7  
 Preset Effects, 4-2  
 Program Effects, 4-2  
 Programming, 4-3  
 Routing Controllers to Effects, 4-7  
 Saving Effects, 4-6  
 Selecting Effects, 4-5  
 Sequencer Effect, 4-2  
 Single Function Effect, 4-3  
 Understanding Effects, 4-1
- Effect Types and Parameters**, 4-8  
 Chorus+Reverb, 4-14  
 Concert Reverb, 4-8, 10  
 Combined Effects, 4-12  
 Delay+Reverb, 4-18  
 Dirty-Rotating Speaker+Delay, 4-21, 22  
 Dynamic Reverb, 4-8, 10  
 Dynamic Hall, 4-8, 10  
 Eight-Voice Chorus, 4-11  
 Flanger+Reverb, 4-15  
 Flanger+Delay+Reverb, 4-20  
 Gated+Room Reverb, 4-12  
 Large Hall Reverb, 4-8  
 Room Reverb, 4-8  
 Rotating Speaker+Delay, 4-21, 22  
 Single Effects, 4-8  
 Small Hall Reverb, 4-8  
 Warm Chamber, 4-8, 10
- Envelopes 1, 2, 3 Pages**, 8-30  
 ADSR, 8-30  
 Diagram, 8-30  
 Editing Envelopes, 8-31  
 Envelope Levels, 8-31  
 Initial, 8-31  
 Break 1, 8-31  
 Break 2, 8-31  
 Peak, 8-31  
 Sustain, 8-31  
 Envelope Times, 8-31  
 Attack, 8-32  
 Decay 1, 8-32  
 Decay 2, 8-32  
 Decay 3, 8-32  
 Release, 8-32  
 Keyboard Tracking, 8-33  
 Envelope Mode, 8-34  
 Velocity Attack, 8-35  
 Velocity Curve, 8-33  
 Velocity Level, 8-35

- Erase**  
 All Sequencer Memory, 5-12  
 Deleting files from disk, 11-12  
 Sequence, 12-7  
 Song, 12-2  
 Track, 12-12
- Event Edit**, 12-15
- Filter**, 8-19  
 Cutoff Frequency, 8-19  
 Filter 1 Page, 8-20  
 Filter 2 Page, 8-21  
 Filter Configurations, 8-21, 22  
 Filter Tracks, 12-19  
 Low-pass/High-pass, 8-19  
 Poles: Rolloff Curves, 8-19
- Footswitch**, 1-4, 11, 5-4, 6-2  
 Input, 1-4  
 FS1 (Aux/Footswitch 1), 6-2, 12-3  
 Advance, 6-2  
 Patch Select Left, 6-2  
 Sequencer Stop/Go, 6-2  
 Sostenuto, 6-2  
 Unused, 6-2  
 FS2 (Footswitch 2), 6-2  
 Patch Select Right, 6-2  
 Sustain, 6-2  
*See also* Master Page
- FX1 and FX2**, 4-3, 4, 5-30, 7-1, 8-24
- Format Disk**, 11-5
- Glide**, 8-17  
 Legato, 8-18  
 Mono, 8-17  
 None, 8-17  
 Pedal, 8-17  
 Trigger, 8-18  
*See also* Pitch Mod Page
- Glide-Time**, 7-8
- Global Controllers**, 6-8  
*See also* MIDI Control Page
- GOTO**, 5-18, 20
- Group Edit Mode (GRP)**, 7-5  
 Selecting more than one voice, 7-5
- Help, Need More**, 1-11
- Key Zone Page**, 3-4  
 Setting the Key Zone, 3-4
- Keyboard Filter Tracking (KBD)**  
*See* Filter 1 or 2 Pages
- Keyboard**  
 Naming using the Keyboard, 6-4, 11-8  
 Pressure (Aftertouch), 1-8  
 Scale Amount, 8-23  
 Setting a Keyboard Zone, 3-4, 8-24  
 Splits, 2-10  
 Touch, 6-1  
 Tracking, 8-5, 33
- Layering Sounds**, 2-3  
 Layered/Primary Sounds, 2-3  
 Layering Programs on a Track, 5-8
- LFO Page**, 8-27  
 Delay, 8-28  
 Level, 8-28  
 Modulation Amount, 8-28  
 Modulation Level, 8-28  
 Noise Source Rate, 8-29  
 Restart Mode, 8-29  
 Waveshapes, 8-28, 29
- Low Battery Voltage**, 1-11
- Locate Page**, 5-18
- Master Page**, 6-1  
 Bend range, 6-2  
 CV-Pedal, 6-3  
 Footswitch (FS1 & FS2), 6-2  
 Keyboard Naming, 6-4  
 MIDI Track Names, 6-4  
 Slider, 6-3  
 System Pitch-Table, 6-3  
 Touch, 6-1  
 Tune (master tuning), 6-1  
 Voice Muting, 6-4
- Merge**, 12-20
- MIDI**  
 Base-Channel, 6-5  
 External Controllers, 6-6  
 Global Controllers, 6-8  
 Guitar Controller, 13-6  
 Implementation Chart, B-1  
 Implementation Spec, A-1  
 MIDI Control Page, 6-5  
 Mode (MIDI In), 6-7  
 Program Changes, 6-9  
 Receiving Program Changes, 6-9  
 Selecting a new Seq/Song 6-9  
 Send-Channel, 6-6  
 Song Selects, 6-8, 13-2  
 System Exclusive, 6-8  
 Transpose Enable, 6-5  
 XCTRL (External Controller), 6-6  
*See also* Mode (MIDI In)  
*See also* Performance MIDI  
*See also* System Exclusives  
*See also* Tracks
- Mixdown** 5-14, 35
- Mode (MIDI In)**, 6-7  
 Mono A, 6-7, 13-6  
 Mono B, 6-7, 13-7  
 Multi, 6-7, 13-4, 5  
 Omni, 6-7  
 Poly, 6-7, 13-6  
*See also* MIDI Control Page
- Mono**  
 Outputs, 1-3, 5-31  
*See also* Mode (MIDI In)
- Mod Mixer Page**, 8-36  
 Mod Shaper Curves, 8-37  
 Scale, 8-37  
 Shape, 8-37  
 Shaper, 8-36  
 SRC-1 & 2, 8-36
- MULTI Mode**, 6-7, 13-4, 5
- Multi-Wave**, 8-13  
 Forward/Reverse, 8-13  
 Length, 8-13  
 Start, 8-13  
*See also* Wave Page
- Muting**  
 Tracks 5-31, 12-4  
 Voices, 6-4
- Output Page**, 8-23  
 Destination Bus, 8-24  
 Keyboard Scale Amount, 8-23  
 Keyboard Zone, 8-24  
 Low/High Key, 8-24  
 Pan Location, 8-25  
 Pan Modulator, 8-25  
 Pan Modulator Amount, 8-25  
 Pre-gain, 8-25  
 Voice Priority, 8-26  
 Velocity Threshold, 8-26  
 Volume, 8-23  
 Volume Modulator, 8-23  
 Volume Modulator Amount, 8-23
- Pages and Sub-pages**, 1-6
- Pan**, 3-1  
 As a Modulator, 8-25  
 Click Pan, 5-13  
 Pan Page, 3-3
- Patch Selects**, 3-1, 6, 7-2  
 Patch Select Page, 3-7  
 Patch Select Assignments, 3-7  
 Programming Patch Selects, 7-6  
 Latching Patch Selects, 3-7

- Performance MIDI Parameters Page**, 3-10
  - MIDI Channel, 3-10, 11
  - MIDI Program Number, 3-10, 12
  - MIDI Status, 3-10
  - Receive, 3-11
  - Transmit, 3-11
- Performance Parameters**, 3-1
  - Key Zone Page, 3-4
  - Multi, 5-2
  - Pan Page, 3-3
  - Patch Select Page, 3-7
  - Pressure Page, 3-8
  - Release Page, 3-6
  - Sustain Page, 3-9
  - Timbre Page, 3-3
  - Transpose Page, 3-5
  - Volume Page, 3-2
- Performance Presets**, 2-1
  - Effects, 3-9
  - See also* Presets
- Pitch Mod Page**, 8-17
  - Envelope 1, 8-18
  - Glide, 8-17
  - LFO, 8-18
  - Modulation Amount, 8-17
  - Modulation Source, 8-17
- Pitch Page**, 8-16
  - Fine tuning, 8-16
  - Pitch-Table, 8-16
  - Octave tuning, 8-16
  - Semitone tuning, 8-16
- Pitch-Table (System)**, 6-3, 8-16, 9-1, 6
  - Alternate tunings, 9-6
  - Custom, 6-3, 8-1, 9-1
  - Normal, 6-3, 8-16
  - On/Off, 7-7
  - See also* Master Page
  - See also* Pitch Page
  - See also* Program Control Page
- Pitch-Tables, Creating**, 9-1
  - All C4, 8-16, 9-1
  - Calculator, 9-5
  - Copy, 9-6
  - Creating, 9-2, 4, 6
  - Custom, 6-3, 8-16, 9-1
  - Editing, 9-3
  - Extrapolation, 9-4, 5
  - Interpolation, 9-6
  - Key-range Start/End, 9-5
  - Removing Custom Pitch-table, 9-4
  - Remove Voices 5 & 6, 9-2
  - System, 9-1
  - See also* Pitch-table (System)
  - See also* Pitch Page
- Presets**, 2-1
  - About Presets, 2-5
  - Editing Presets, 2-6
  - Effects, 3-9
  - Preset Location, 2-8
  - Preset Memory, 2-6
  - Preset Mode, 2-4
  - Saving Presets, 2-8
  - Selecting Presets, 2-6
- Pressure (After-touch)**, 1-8
  - As a Modulator, 8-6, 7
  - Pressure Page, 3-8
    - Channel Pressure, 3-8
    - Poly-Key Pressure, 3-8
- Programming**, 7-1
- Programs**, 2-1
  - Replace Program, 2-9, 5-8
  - What is a Program, 7-1
- Program Changes**, 6-9
  - Recording, 5-29
  - See also* MIDI Control Page
- Program Control Page**, 7-7
  - Bend-Range, 7-7
  - Delay, 7-7
  - Glide-Time, 7-8
  - Pitch-Table, 7-7
  - Restrike, 7-8
- Program Memory**, 2-1
  - Cart Memory, 2-1
  - Internal Memory, 2-1
  - ROM Memory, 2-1
- Punching In**, 5-21, 25
- Quantize**, 12-12
- Range, Track Edit**, 12-10
- Rear Panel Connections**, 1-3
  - Aux Outputs, 1-3
  - Foot Switch Input, 1-4
  - Main Outputs, 1-3
  - MIDI In/Out/Thru, 1-3
  - Pedal/CV Input, 1-3
  - Phones, 1-3
- Re-initialization**, 1-10
  - When to Re-initialize, 1-10
- Release**, 3-1
  - Release Page, 3-6
- Replace Program**, 2-9, 5-8
  - Replacing a Program/Effect in a Preset, 2-9, 10
  - Replacing a Program/Effect in a Sequence, 5-8
  - Seq/Auditioning new sounds, 5-26
- Restrike**, 7-8
- Reverb**
  - See* Effects
- Save changes...** page, 5-16, 17
- Select Voice Page**, 7-4
  - Group Edit Mode, 7-5
  - Short Cuts, 7-5
  - Voices: active, muted, soloed, 7-4
- Send Channel**, 6-5, 6
- Sequencer**
  - Applications, 13-1
  - Banks, 5-6
  - Edit Sequence Page, 12-6
  - Edit Track Page, 12-10
  - Erase Sequencer Memory, 5-12
  - External Sequencer, 13-5
  - MIDI Sequencing, 5-27
  - Operating System Version, 5-3, 16
  - Seq Control Page, 5-14
  - Sequencer Mode, 2-4
  - Status, 5-5
  - Templates, 13-2
  - Transport controls, 5-4
  - See also* Song Mode
- Signal Processing**
  - See* Effects
- Soloing**
  - Tacks, 5-31
  - Voices, 7-4
- Song Mode**, 5-32
  - Edit Song Page, 12-1
  - Mixing down tracks, 5-35, 36
  - Song Position Pointers, 13-2
  - Song Step Editor Page, 12-3, 4
  - Song Tracks, 5-33
  - Switching Effects, 5-32
  - Viewing Sequencer Tracks, 5-34
- Sounds**, 2-1, 2
  - Cart Sounds, 2-1, 2
  - Internal Sounds, 2-1, 2
  - Layering, 2-3
  - ROM Sounds, 2-1, 2
  - Selecting, 2-2
- Step edit**
  - See* Event edit
- Storage**
  - Disk, 11-2
  - Cartridge, 11-15
  - Sys-Ex, 11-13, 14



- Sustain Page, 3-9
  - See also Master Page
- System Exclusive (Sys-Ex), 6-8
  - Loading data to an external device, 11-23
  - MIDI Sys-Ex Recorder, 11-20
  - Saving data from an external device, 11-21
  - See also MIDI Control Page
- Template Sequences, 13-2, 3
- Tempo, 5-15, 18, 20
  - Tap Tempo, 5-13
- Touch, 6-1
- Tune
  - Master tuning, 6-1
  - See also Pitch Page
- Timbre, 3-1, 8-5
  - Timbre Page, 3-3
  - Using the Slider, 6-3
- Tracks, 2-4, 5-7
  - Editing, 12-10
  - Event Editing, 12-15
  - MIDI, 5-27
  - Mixdown, 5-35, 36
  - Performance Parameters, 3-1
  - Quantize, 12-12
  - Recording, 5-23
  - Song Tracks, 5-33
  - Track Control parameters, 3-6
  - Volume, 3-2, 5-31
- Transpose
  - MIDI Transpose Enable, 6-5
  - Track, 12-4, 14
  - Transpose Page, 3-5
  - See also Wave Page
- Trans-Wave, 8-8, 9, 12
- Voice(s)
  - Sequence Effect, 4-7
  - Voice Muting, 6-4
  - Voice Priority, 8-26
  - Voices: active, muted, soloed, 7-4
  - Voices and Polyphony, 7-2
  - Voice Stealing, 7-2, 8-26, 34
  - See Select Voice Page
  - See Programming
- Volume, 1-2, 3-1
  - Track, 3-2, 5-31
  - Volume Page, 3-2
- Warnings
  - Disk Error Warnings, 11-25
  - Disk Fatal Error Messages, 11-25, 26
- Wave Page, 8-8
  - Delay, 8-10
  - Drum Sounds, 8-14
  - Forward/Reverse, 8-11
  - Multi-Wave Parameters, 8-13
  - Start, 8-11
  - Trans-Wave Parameters, 8-12
  - Triggering voice with Key up, 8-10
  - Type-specific wave Parameters, 8-11
  - Velocity-Start Modulation, 8-11
  - Wave Class, 8-8, 10
  - Waveform & Inharmonic Parameters, 8-13
  - Wave List, 8-9
  - Wave Name, 8-10
  - Wave Type, 8-10
- Write Page, 7-9
  - Writing to Cartridge, 7-9
  - Writing to Internal Memory, 7-9
- XCTRL (External Controller), 6-6, 8-6
  - See also MIDI Control Page

Tracking Curves

QUIKRISE	CONCAVE4
CONVEX-1	LATERISE
CONVEX-2	QUANT-32
CONVEX-3	QUANT-16
LINEAR	QUANT-08
CONCAVE1	QUANT-04
CONCAVE2	QUANT-02
CONCAVE3	SMOOTHER

Envelope Parameters

Levels: Attack, Peak, Break1/2, Sustain
Times: Attack, Decay1/2/3, Release
Velocity Curve (first 10 curves)
Keyboard tracking
Velocity control of Attack and Level
Envelope Mode (normal/finish/repeat)

VFX<sup>SD</sup> Voice Configuration

Mod Sources

LFO	PEDAL
ENV 1	PITCH
ENV 2	XCTRL
NOISE	PR+VL
MIXER	WL+PR
VELOC	WHEEL
KEYBD	PRESS
TIMBR	*OFF*

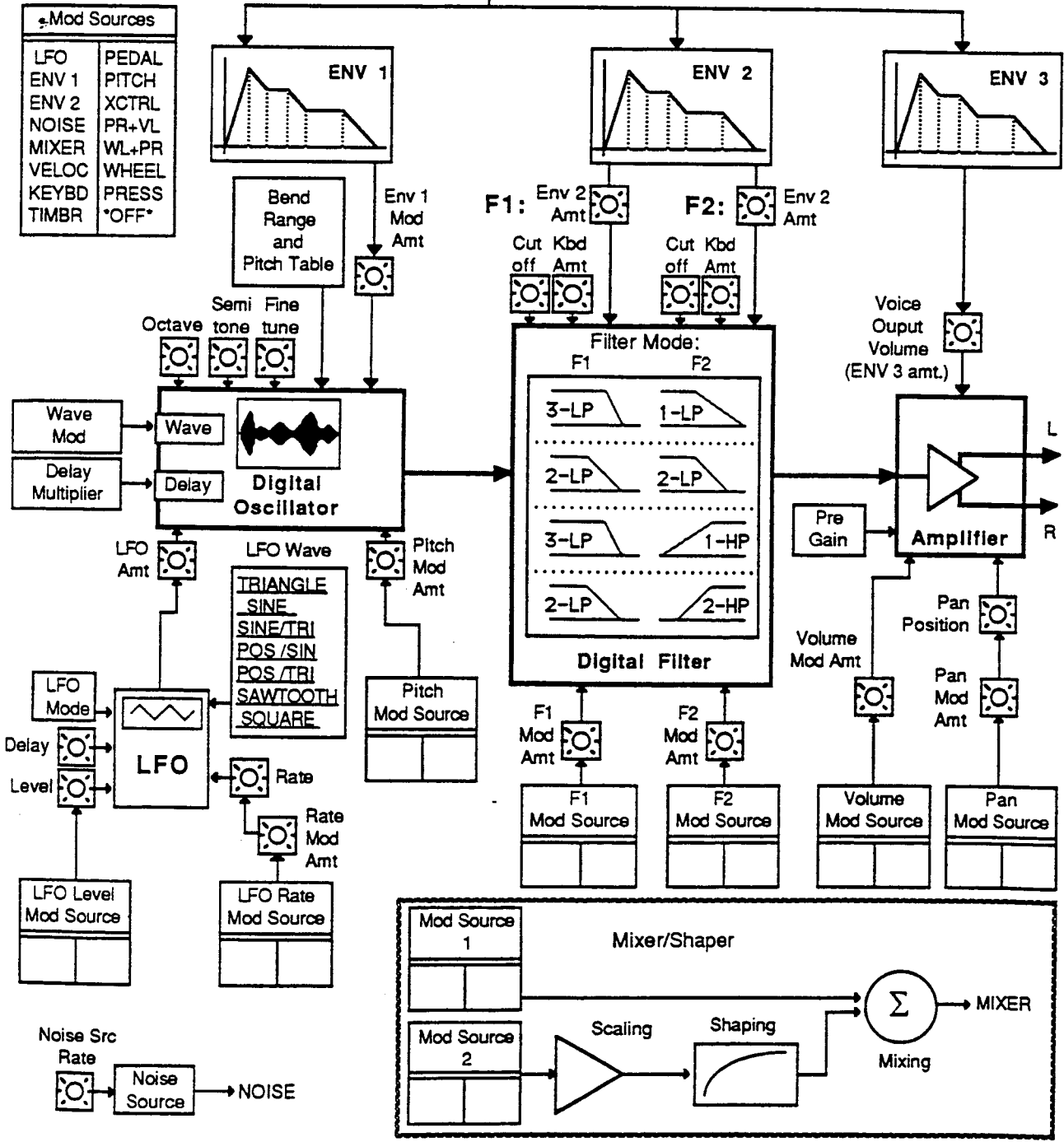

### Effects Routing

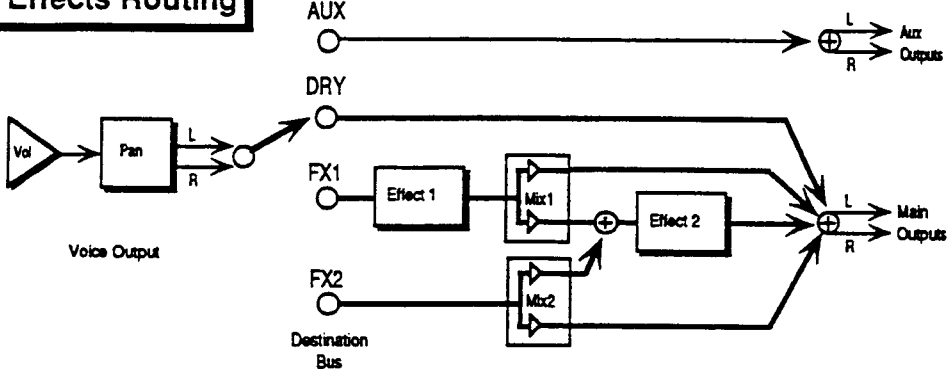

### Performance Parameters:

- Volume
- Pan
- Timbre\*
- Key Zone
- Transpose
- Release\*
- Track Control:
  - Patch Selects
  - Pressure mode\*
  - Sustain
- MIDI:
  - Status
  - Channel
  - Program
  - Effects Routing

(\* These three are saved with the program. All other Performance parameters are reset to default values whenever a new sound is selected.)

### Envelope

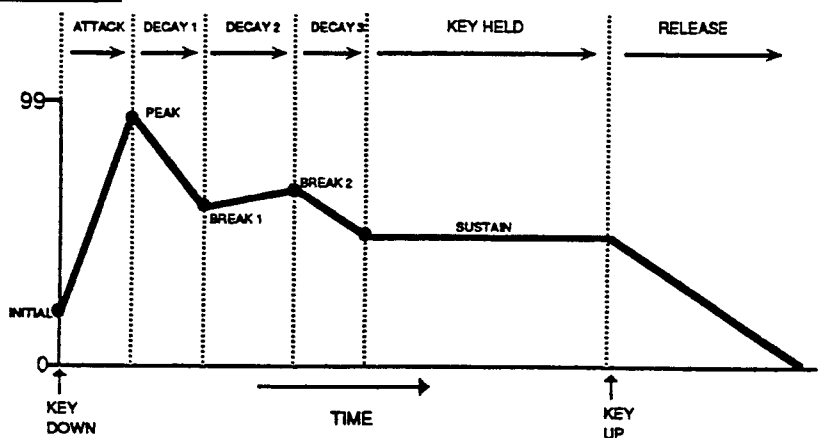

### Tracking Curves

These 16 tracking curves are used by the Mod Mixer/Shaper. The first ten curves are also used as envelope velocity curves.

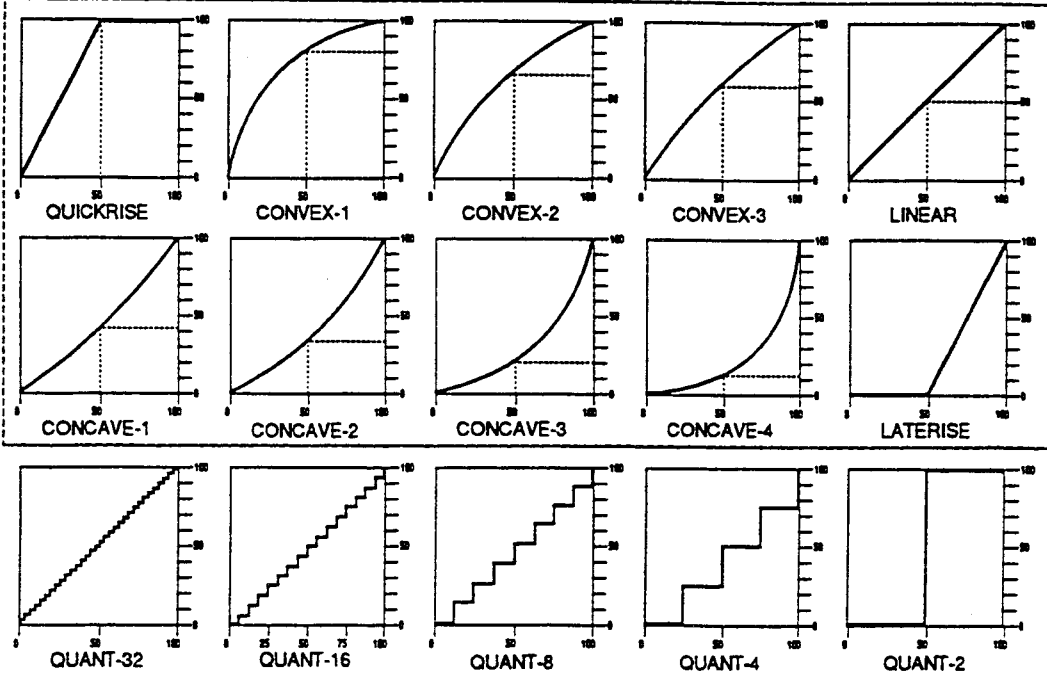

### Envelope VEL-CURVES

SMOOTHER  
 — = input  
 — = output

**"INSTRUCTIONS PERTAINING TO A RISK OF FIRE,  
ELECTRIC SHOCK, OR INJURY TO PERSONS"**

**IMPORTANT SAFETY INSTRUCTIONS**

WARNING—When using electric products, basic precautions should always be followed, including the following:

1. Read all the instructions before using the product.
2. Do not use this product near water - for example, near a bathtub, washbowl, kitchen sink, in a wet basement, or near a swimming pool, or the like.
3. This product should be used only with a cart or stand that is recommended by the manufacturer.
4. This product, either alone or in combination with an amplifier and headphones or speakers, may be capable of producing sound levels that could cause permanent hearing loss. Do not operate for a long period of time at a high volume level or at a level that is uncomfortable. If you experience any hearing loss or ringing in the ears, you should consult an audiologist.
5. The product should be located so that its location or position does not interfere with its proper ventilation.
6. The product should be located away from heat sources such as radiators, heat registers, or other products that produce heat.
7. The product should be connected to a power supply only of the type described in the operating instructions or as marked on the product.
8. This product may be equipped with a polarized line plug (one blade wider than the other). This is a safety feature. If you are unable to insert the plug into the outlet, contact an electrician to replace your obsolete outlet. Do not defeat the safety purpose of the plug.
9. The power supply cord of the product should be unplugged from the outlet when left unused for a long period of time.
10. Care should be taken so that objects do not fall and liquids are not spilled into the enclosure through openings.
11. The product should be serviced by qualified service personnel when:
  - a. The power supply cord or the plug has been damaged; or
  - b. Objects have fallen, or liquid has been spilled into the product; or
  - c. The product has been exposed to rain; or
  - d. The product does not appear to operate normally or exhibits a marked change in performance;  
or
  - e. The product has been dropped, or the enclosure damaged.
12. Do not attempt to service the product beyond that described in the user-maintenance instructions. All other servicing should be referred to qualified service personnel.

**SAVE THESE INSTRUCTIONS**

Part # 9310006301

Model #MM-41-01

**ensoniq**<sup>®</sup>

THE TECHNOLOGY THAT PERFORMS